



US00D564543S

(12) **United States Design Patent**
Bucher et al.

(10) **Patent No.:** **US D564,543 S**
(45) **Date of Patent:** **** Mar. 18, 2008**

(54) **DISCHARGE CHUTE**
(75) Inventors: **Corey W. Bucher**, Wrightstown, WI (US); **John H. Feller**, Kaukauna, WI (US)
(73) Assignee: **Ariens Company**, Brillion, WI (US)

4,322,938 A 4/1982 Efflandt
4,502,271 A 3/1985 Hansen et al.
4,672,799 A 6/1987 Parish
4,882,898 A 11/1989 Samejima et al.
5,003,757 A 4/1991 Hill
5,101,617 A 4/1992 Hare et al.
5,163,274 A 11/1992 Burdsall et al.

(**) Term: **14 Years**

(Continued)

(21) Appl. No.: **29/295,356**

OTHER PUBLICATIONS

(22) Filed: **Sep. 27, 2007**

John Deere 9660 STS, http://www.deere.com/en_US/ag/feature/2005/9660_sts_combine_hur_jan05.html.

Related U.S. Application Data

Primary Examiner—Stella M. Reid
Assistant Examiner—Mark Goodwin

(63) Continuation of application No. 29/249,989, filed on Oct. 30, 2006, now Pat. No. Des. 556,788.

(74) *Attorney, Agent, or Firm*—Michael Best & Friedrich LLP

(51) **LOC (8) Cl.** **15-03**
(52) **U.S. Cl.** **D15/17**
(58) **Field of Classification Search** D15/15, D15/17, 28; 56/15.7, 13.3, 200, 320.1, 320.2, 56/202, 192, 16.6, 17.4, 314, 316, 255, DIG. 20, 56/DIG. 22, DIG. 24
See application file for complete search history.

(57) **CLAIM**

The ornamental design for a discharge chute, as shown and described.

DESCRIPTION

(56) **References Cited**

FIG. 1 is a perspective view of a discharge chute according to the present invention.

U.S. PATENT DOCUMENTS

FIG. 2 is an enlarged perspective view of the discharge chute shown in FIG. 1.

- 2,756,556 A 7/1956 Watkins
- 3,049,853 A 8/1962 Horner et al.
- 3,503,194 A 3/1970 Ritums
- 3,568,421 A 3/1971 Smith et al.
- 3,646,739 A 3/1972 Dahl
- 3,648,445 A 3/1972 Efflandt
- 3,673,778 A 7/1972 Ramey
- 3,721,078 A * 3/1973 Haffnet 56/202
- 3,760,572 A 9/1973 Marion et al.
- 3,797,214 A 3/1974 Erdman et al.
- 3,805,499 A 4/1974 Woelffer et al.
- 3,818,687 A 6/1974 Houst et al.
- 4,008,559 A 2/1977 Lessig, III et al.
- 4,041,682 A 8/1977 Kidd
- D250,193 S 11/1978 Oosterling et al.
- 4,142,351 A 3/1979 Neice et al.
- 4,258,539 A 3/1981 Pearce et al.

FIG. 3 is a side view of the discharge chute shown in FIG. 1.

FIG. 4 is a front view of the discharge chute shown in FIG. 1.

FIG. 5 is a rear view of the discharge chute shown in FIG. 1.

FIG. 6 is a top view of the discharge chute shown in FIG. 1; and,

FIG. 7 is a bottom view of the discharge chute shown in FIG. 1.

The broken line showing of the environment is for illustrative purposes only and forms no part of the claimed design.

1 Claim, 4 Drawing Sheets

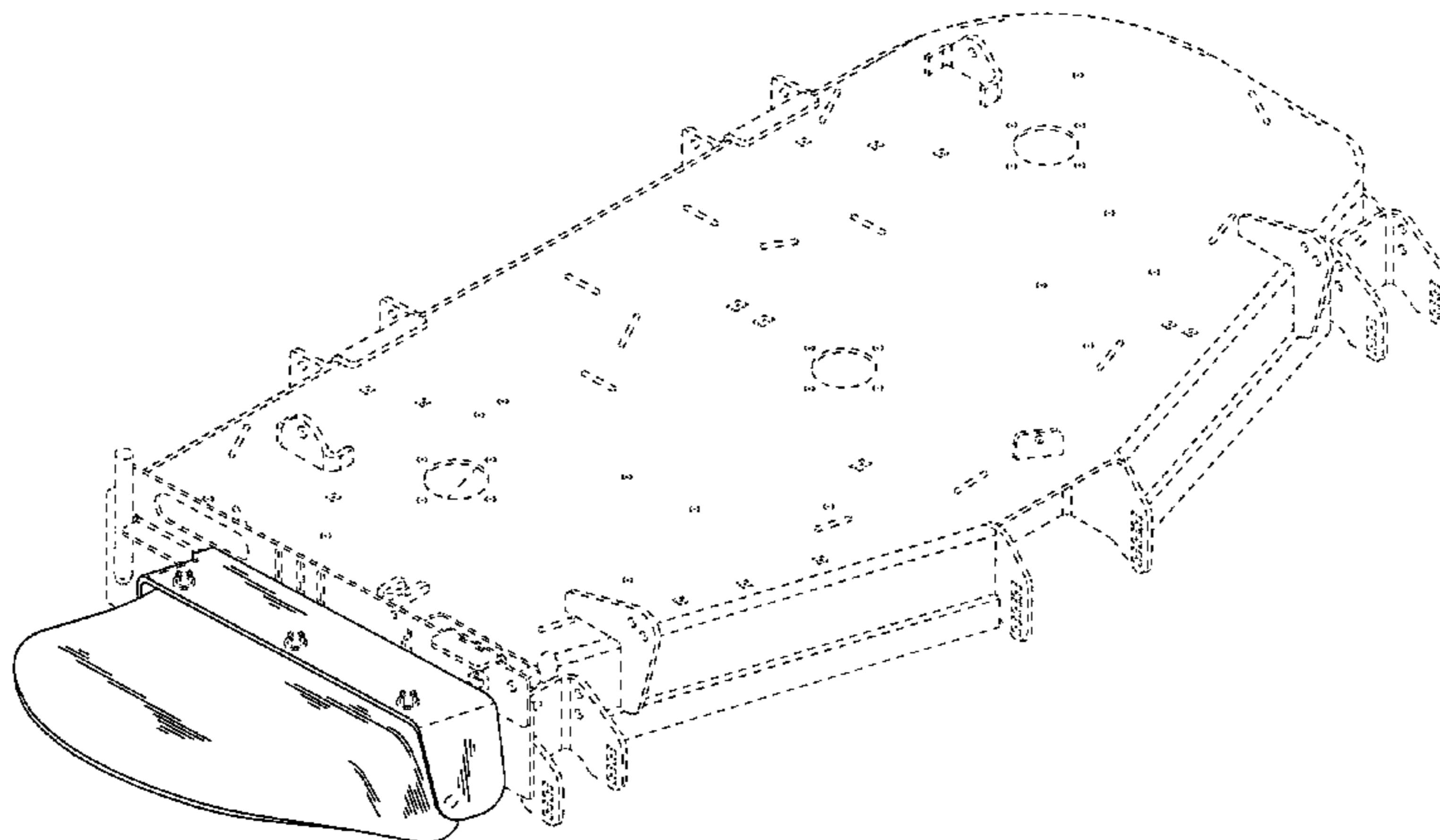

US D564,543 S

Page 2

U.S. PATENT DOCUMENTS

5,195,311 A	3/1993	Holland	6,588,188 B2	7/2003	Dennis
5,331,794 A	7/1994	Reichle	6,971,224 B1	12/2005	Hancock
D354,964 S	1/1995	Reichle	6,986,240 B2	1/2006	Kallevig
5,491,964 A	2/1996	Butler	7,204,073 B1	4/2007	Chenevert
5,499,494 A	3/1996	Boshell et al.	2003/0019201 A1	1/2003	Eavenson, Sr.
5,518,079 A	5/1996	Zvolanek	2004/0112031 A1	6/2004	Dickey
5,913,804 A	6/1999	Benway	2004/0231311 A1	11/2004	Kallevig
5,992,135 A	11/1999	Benway	2005/0279072 A1	12/2005	Sarver et al.
6,012,274 A	1/2000	Eavenson et al.	2006/0037299 A1	2/2006	Kallevig

* cited by examiner

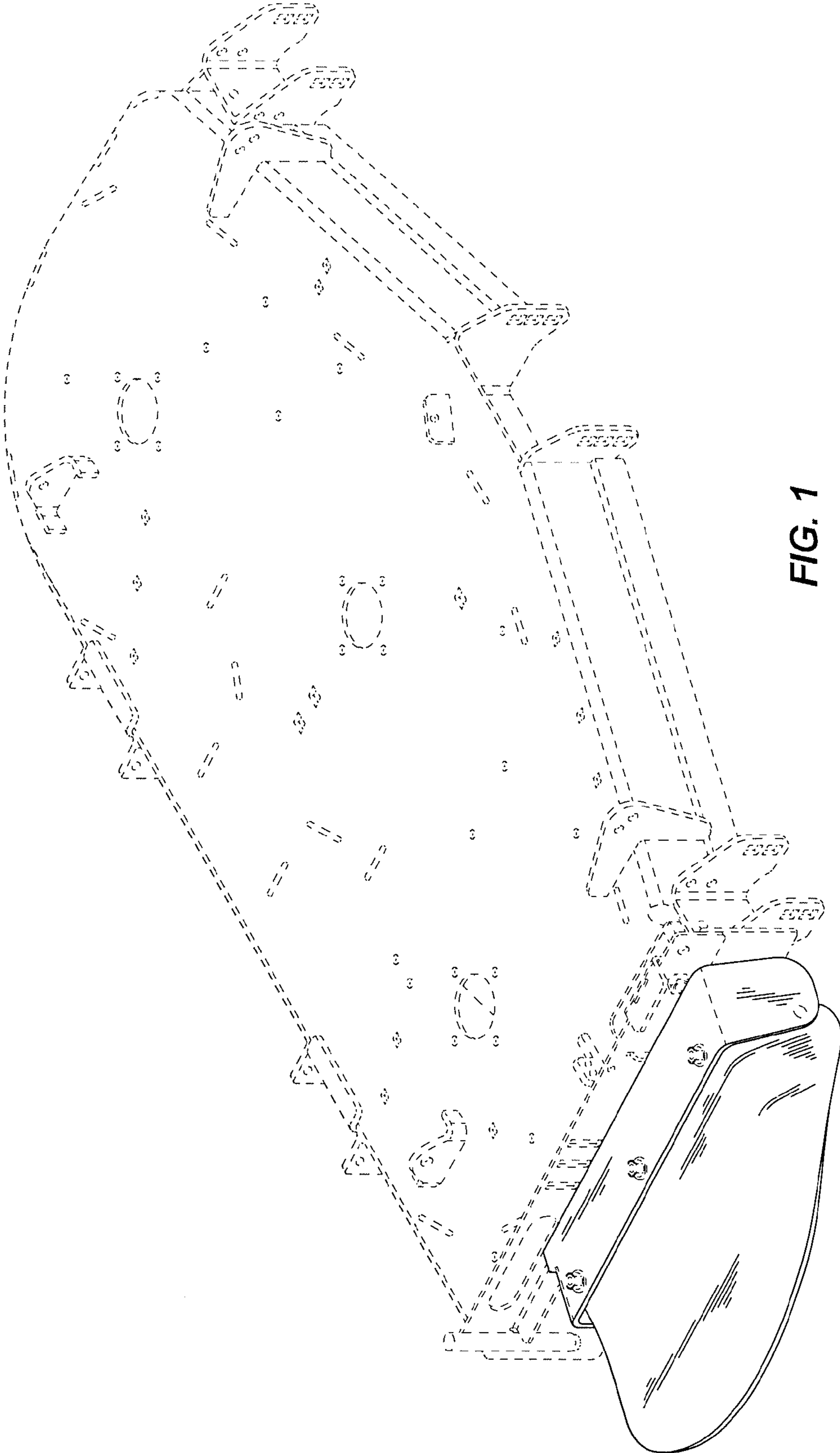

FIG. 1

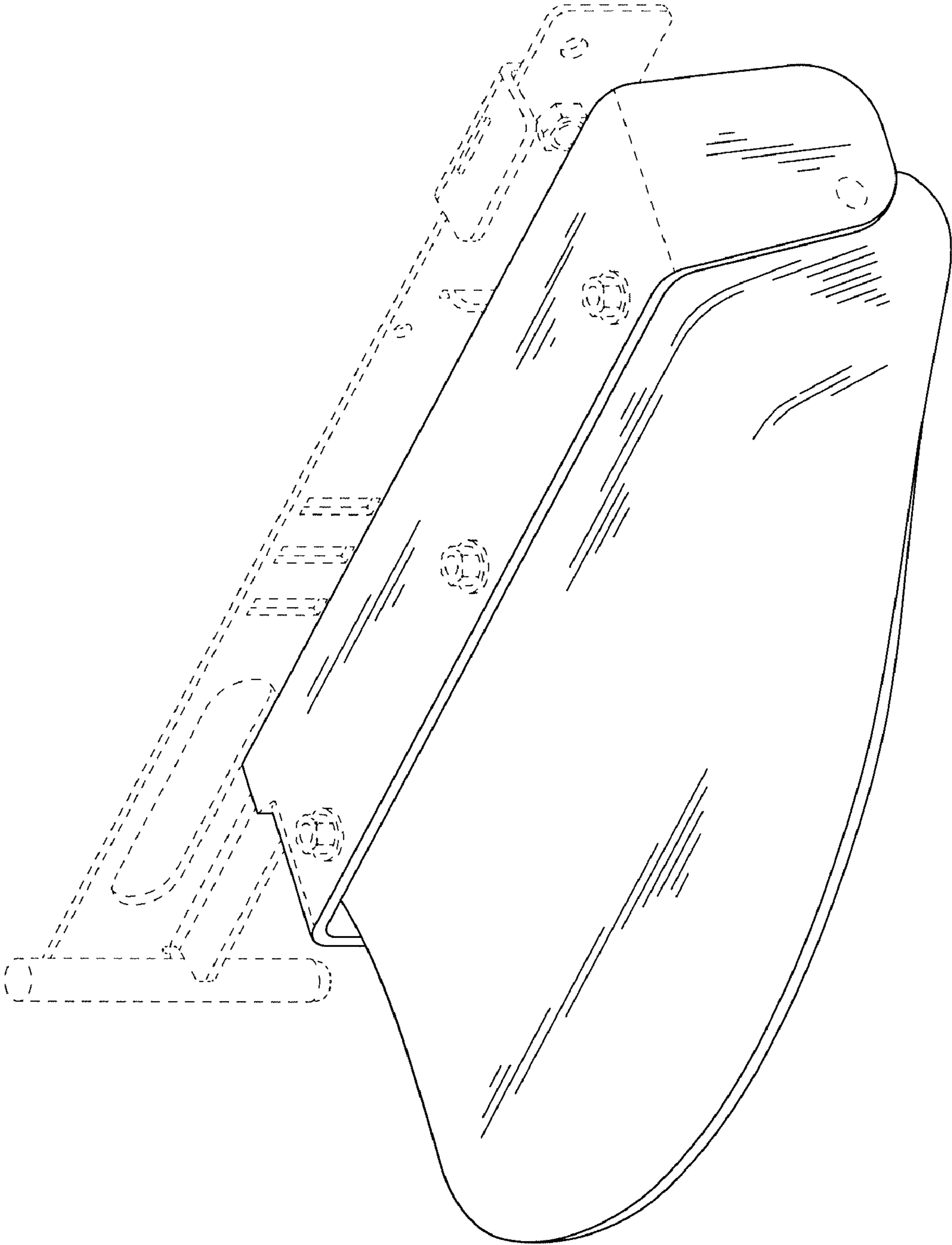

FIG. 2

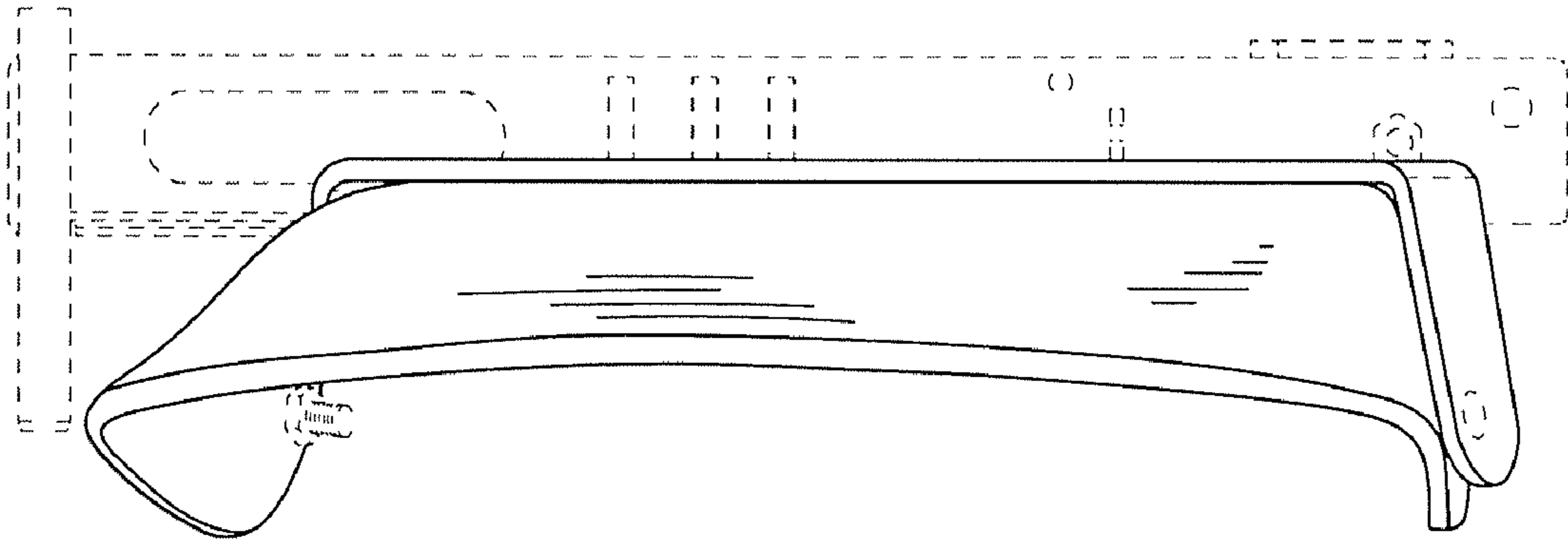

FIG. 3

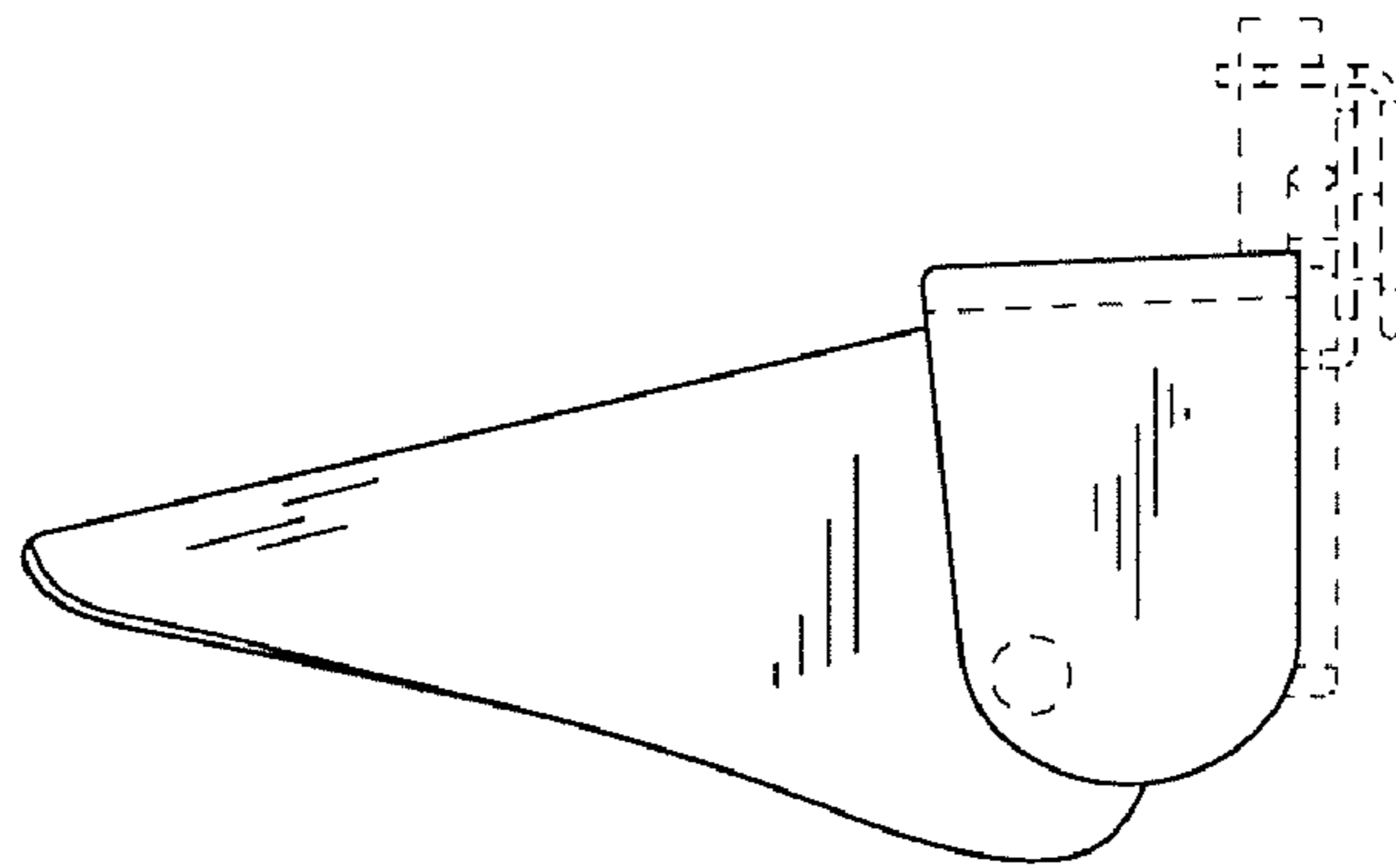

FIG. 4

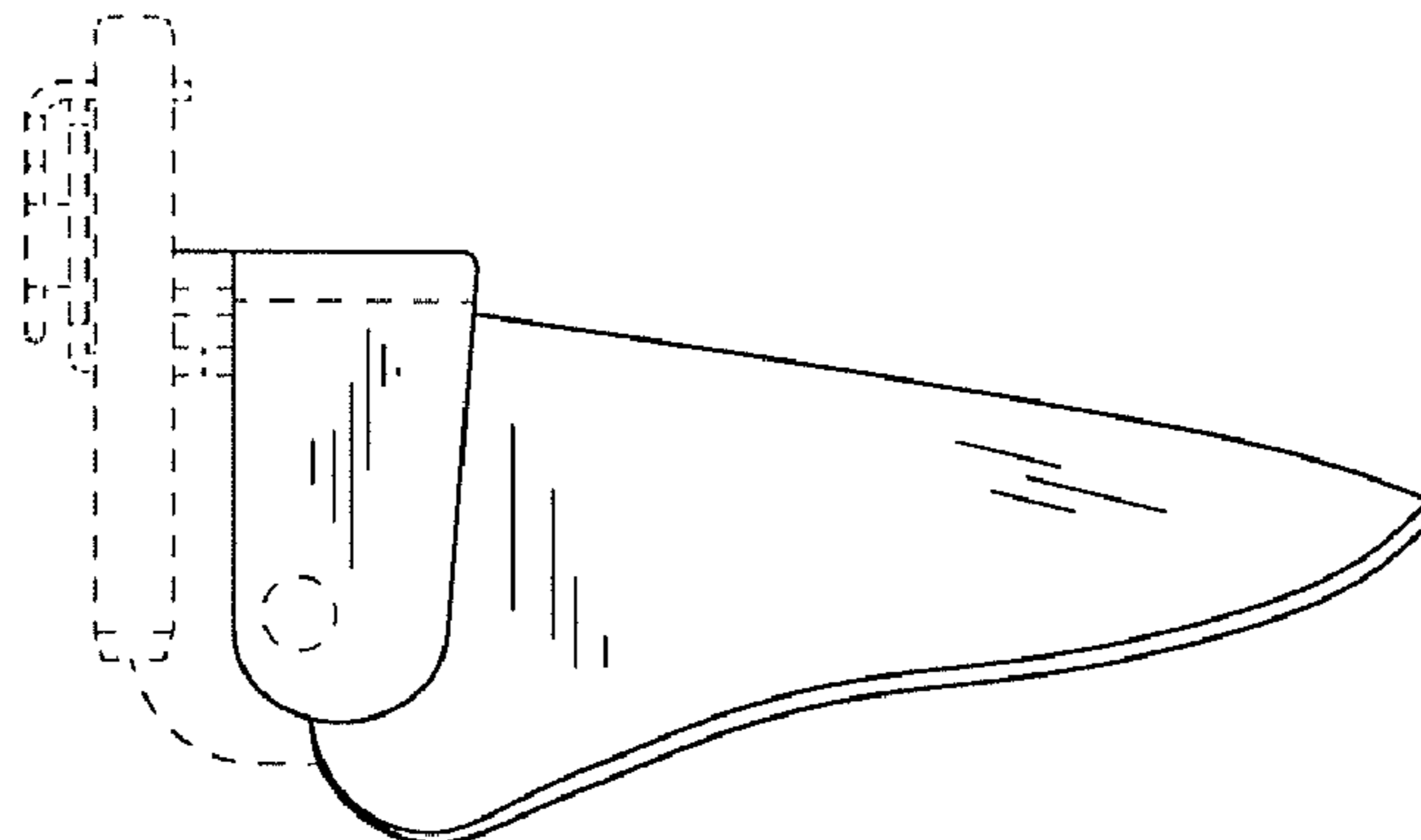

FIG. 5

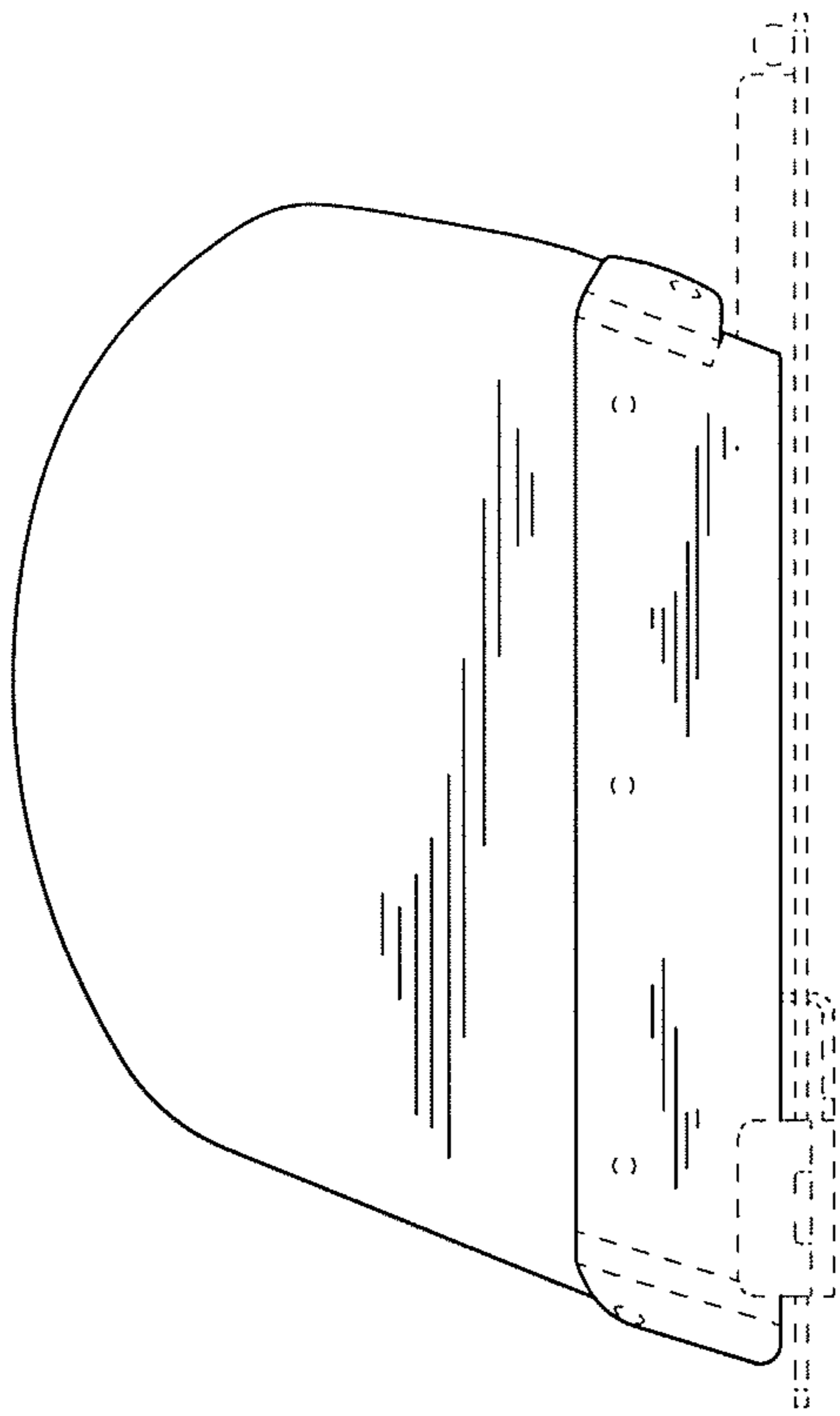

FIG. 6

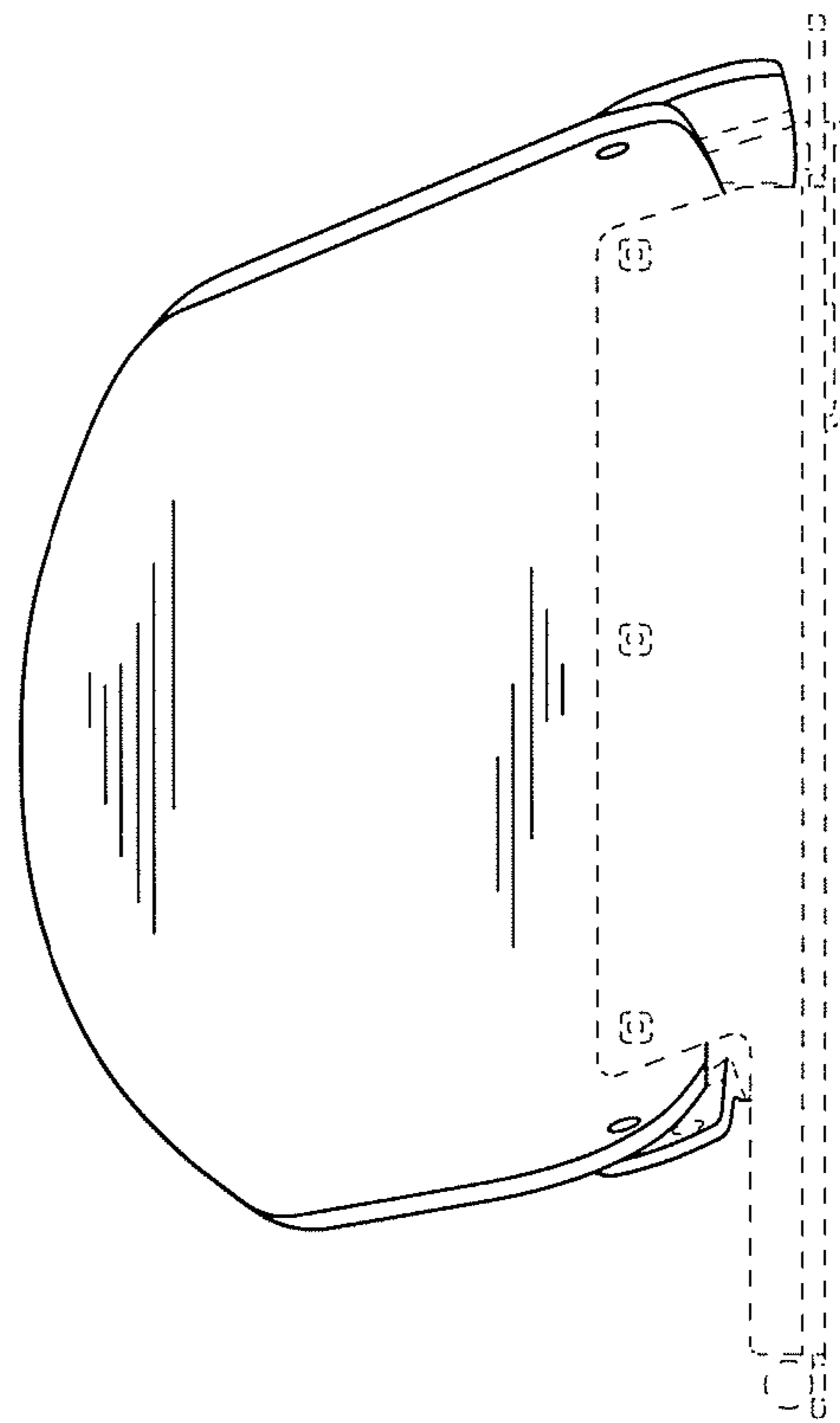

FIG. 7