

US00D564497S

(12) **United States Design Patent**
Langberg et al.

(10) **Patent No.:** **US D564,497 S**
(45) **Date of Patent:** **** Mar. 18, 2008**

(54) **SET OF PORTABLE SPEAKERS**

D508,909 S * 8/2005 Harris, Jr. et al. D14/211

(75) Inventors: **Eric Aaron Langberg**, Milford, PA (US); **Richard Messerle**, Port Jervis, NY (US); **Amy Kristin Barnett**, Long Valley, NJ (US); **Aaron Hayes**, Portland, OR (US); **Thomas Swyst**, Arlington, VA (US); **Matthew Esecson**, Prides Crossing, MA (US)

* cited by examiner

Primary Examiner—Nanda Bondade
(74) *Attorney, Agent, or Firm*—Richard E. Kurtz; Greenberg Traurig, LLP

(73) Assignee: **Altec Lansing, a division of Plantronics, Inc.**, Milford, PA (US)

(57) **CLAIM**

The ornamental design for set of portable speakers, as shown and described.

(**) Term: **14 Years**

DESCRIPTION

(21) Appl. No.: **29/275,644**

FIG. 1 is a perspective view of a first speaker of the set of portable speakers showing the present design;

(22) Filed: **Jan. 3, 2007**

FIG. 2 is front elevational view thereof;

(51) **LOC (8) Cl.** **14-01**

FIG. 3 is a rear elevational view thereof;

(52) **U.S. Cl.** **D14/214**

FIG. 4 is a right side elevational view thereof;

(58) **Field of Classification Search** D14/204,
D14/209–216; 181/143–144, 147–148, 150,
181/157, 198–199, 151, 153; 381/300–302,
381/306, 333, 345, 361–364, 386–388, 332,
381/336

FIG. 5 is a left side elevational view thereof;

FIG. 6 is a top plan view thereof;

FIG. 7 is a bottom plan view thereof;

FIG. 8 is a perspective view of a second speaker of the set of portable speakers;

FIG. 9 is a top plan view thereof;

FIG. 10 is a bottom plan view thereof; and,

FIG. 11 is a left side elevational view thereof in a closed position.

See application file for complete search history.

(56) **References Cited**

U.S. PATENT DOCUMENTS

D306,024 S * 2/1990 Eberbach D14/214
D425,897 S * 5/2000 Cho D14/214
D457,875 S * 5/2002 Joe D14/211

1 Claim, 11 Drawing Sheets

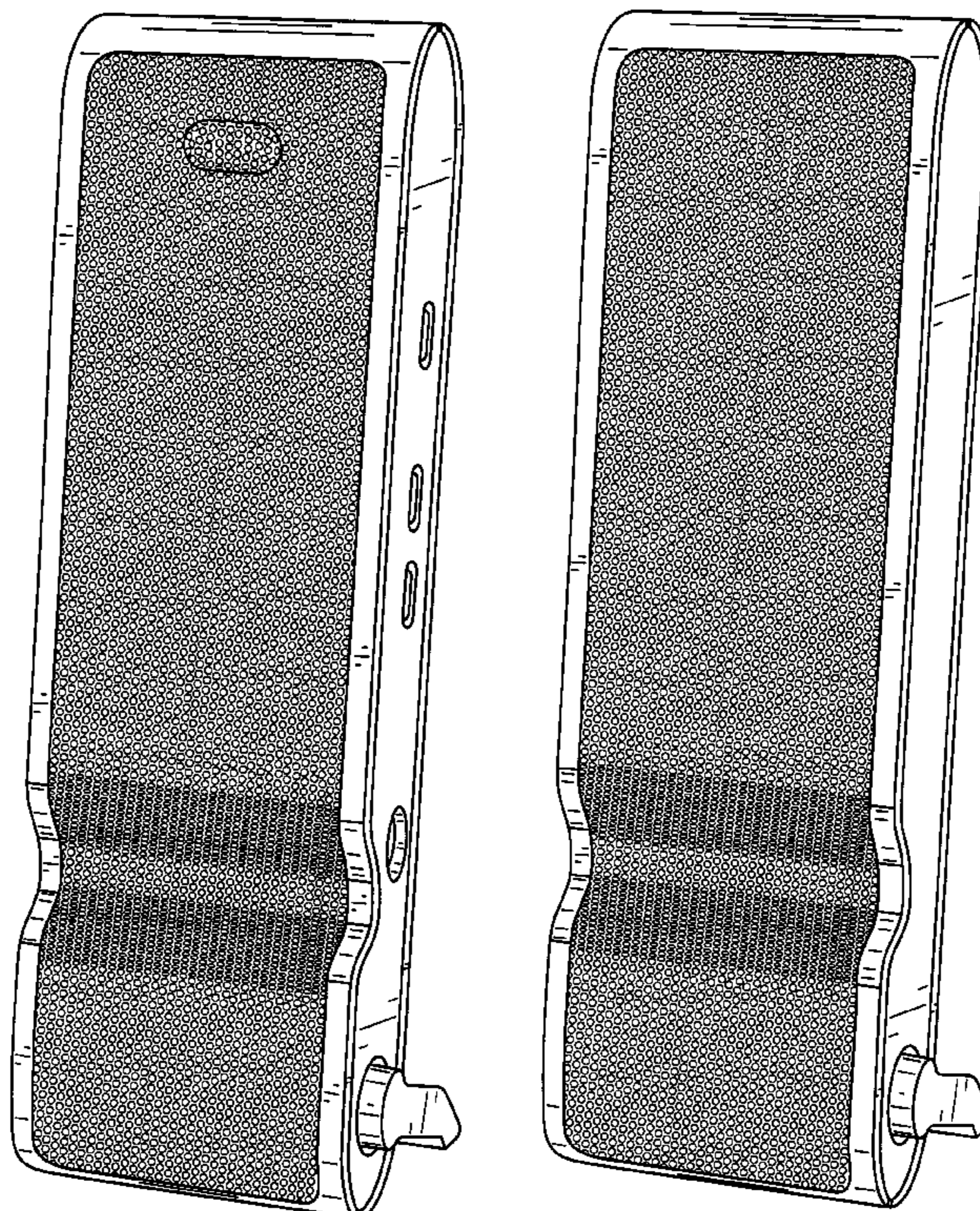

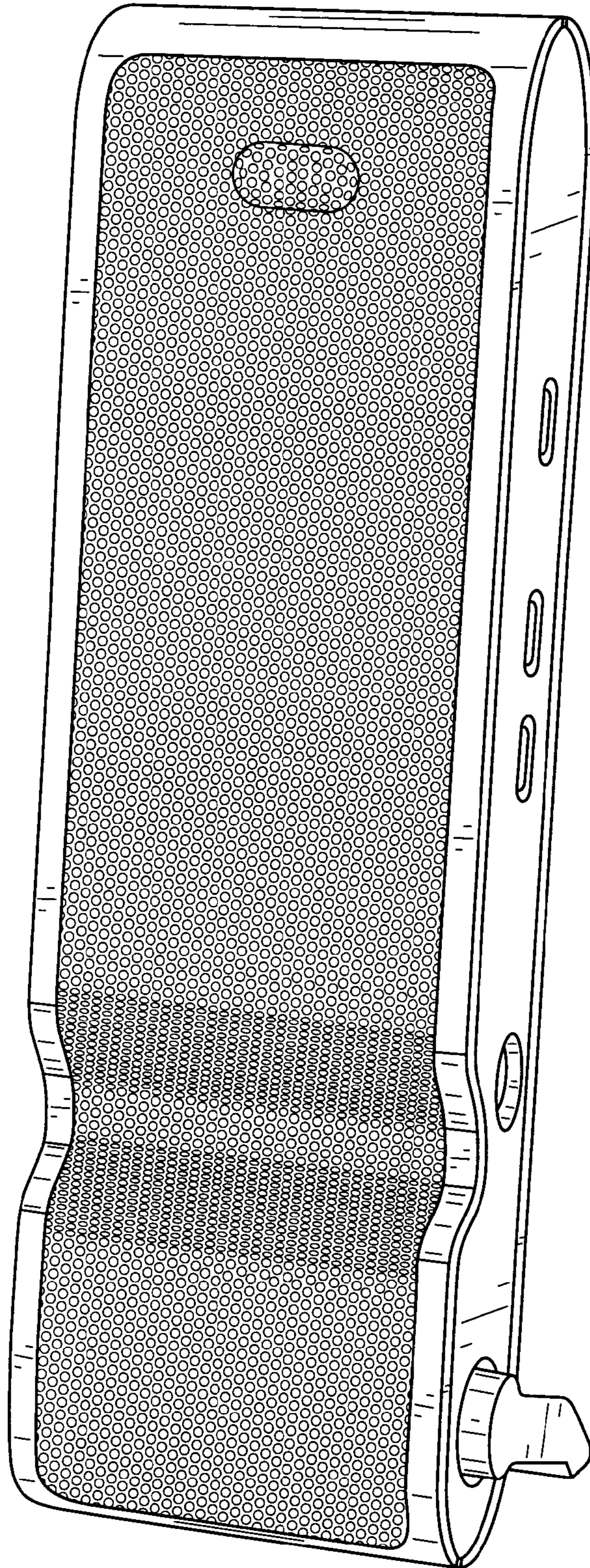

FIG. 1

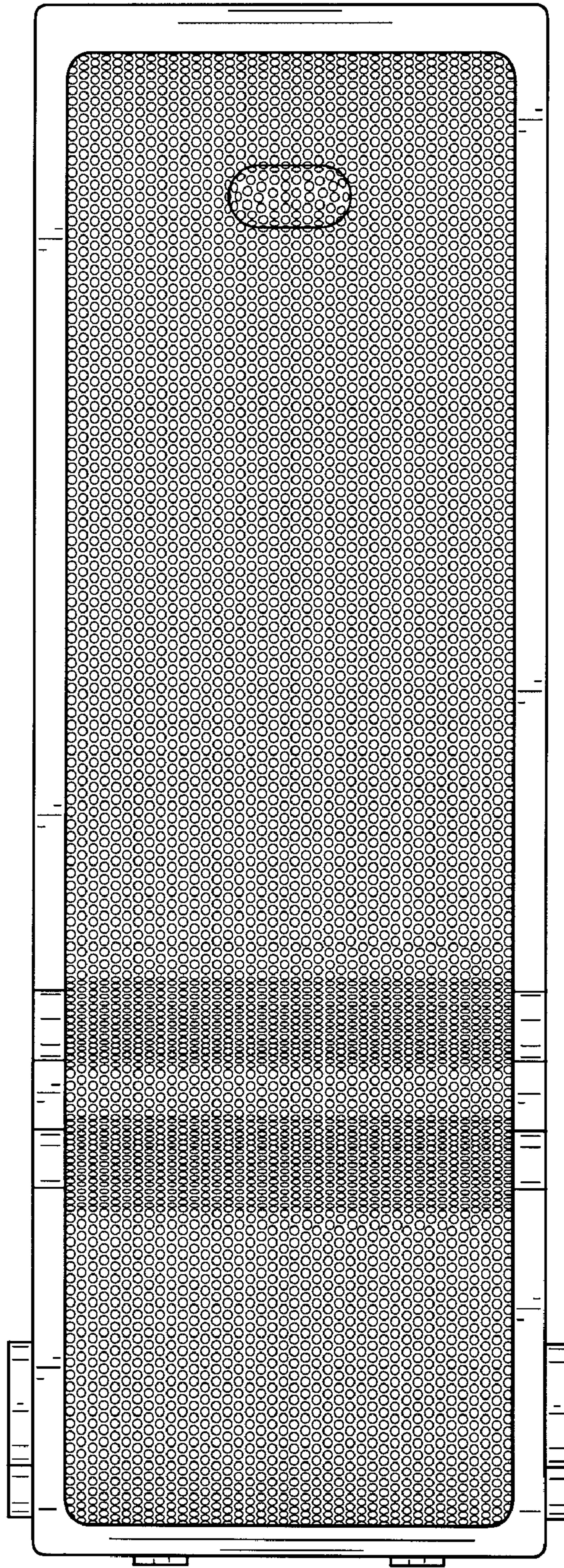

FIG. 2

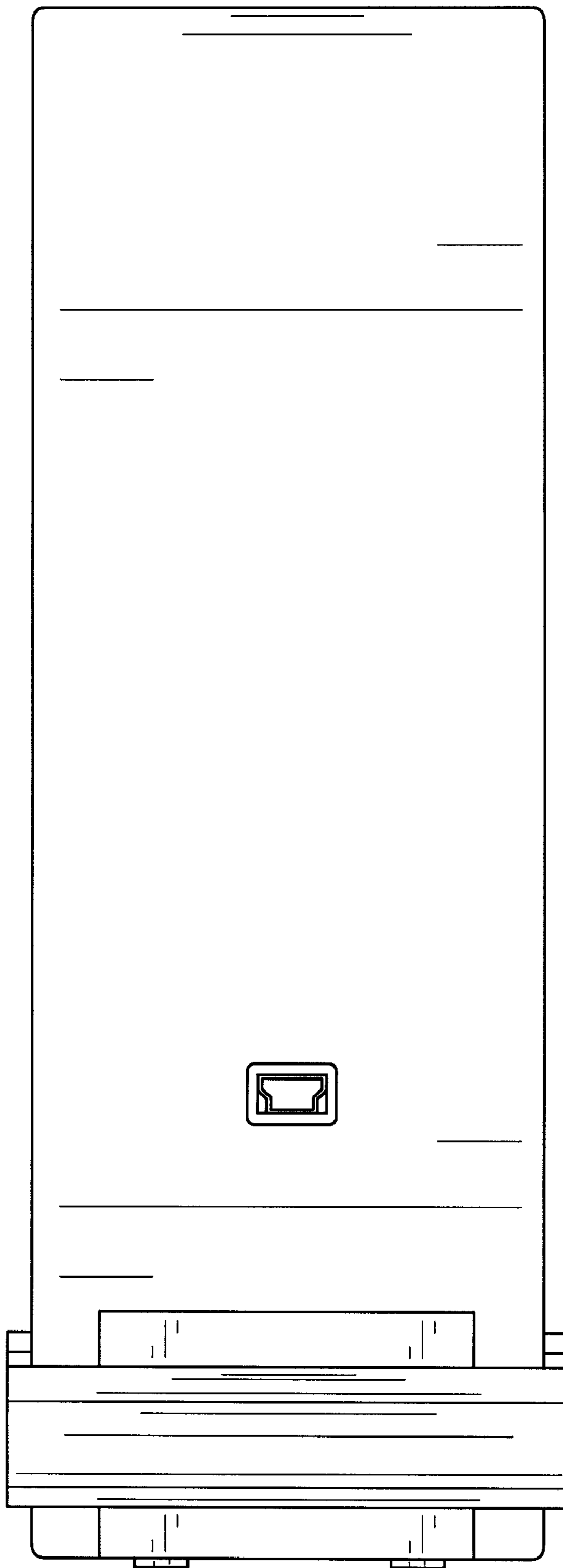

FIG. 3

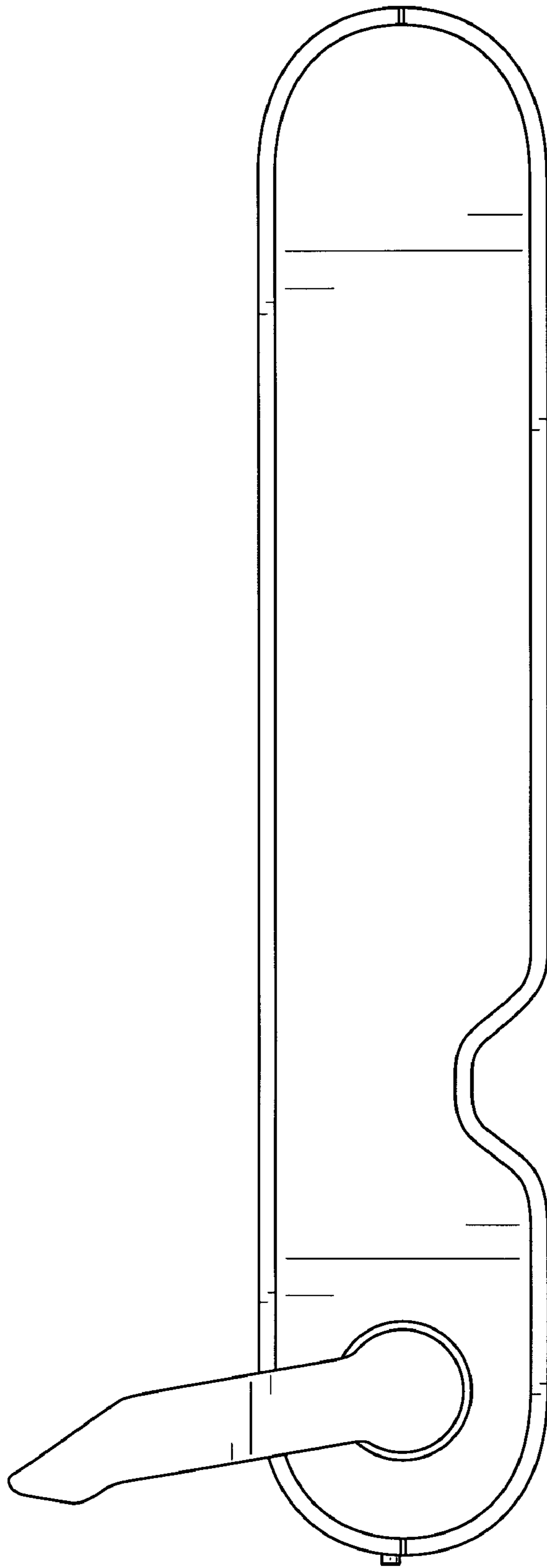

FIG. 4

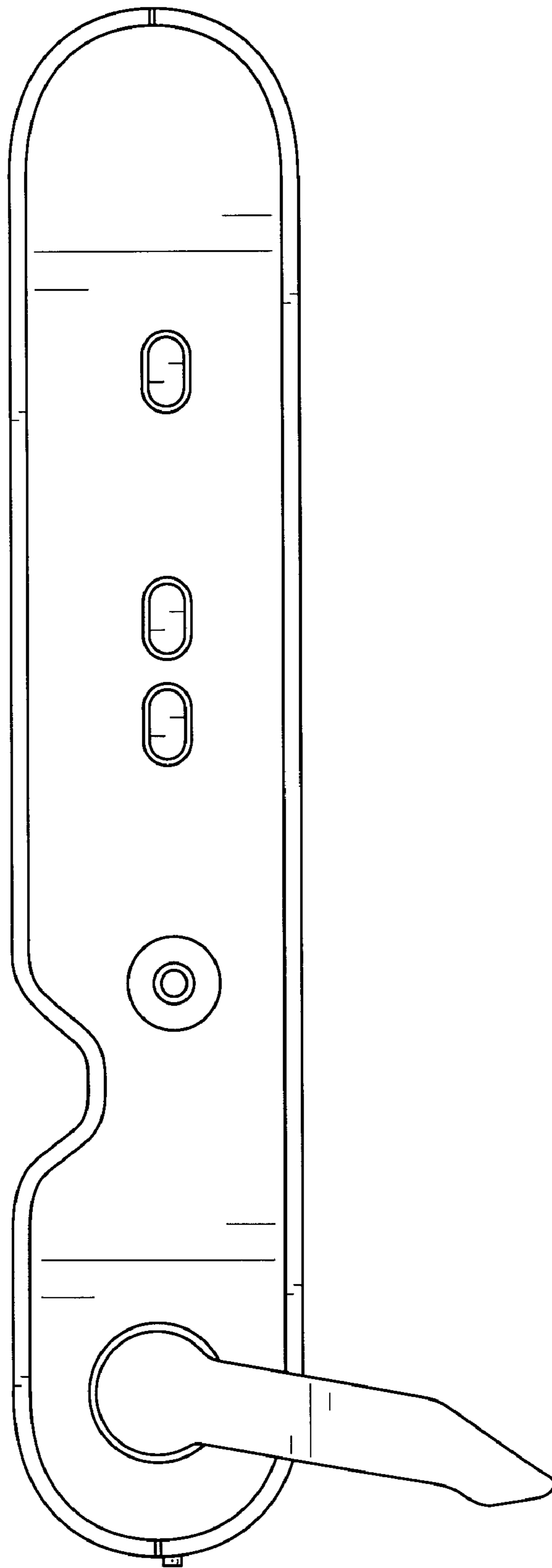

FIG. 5

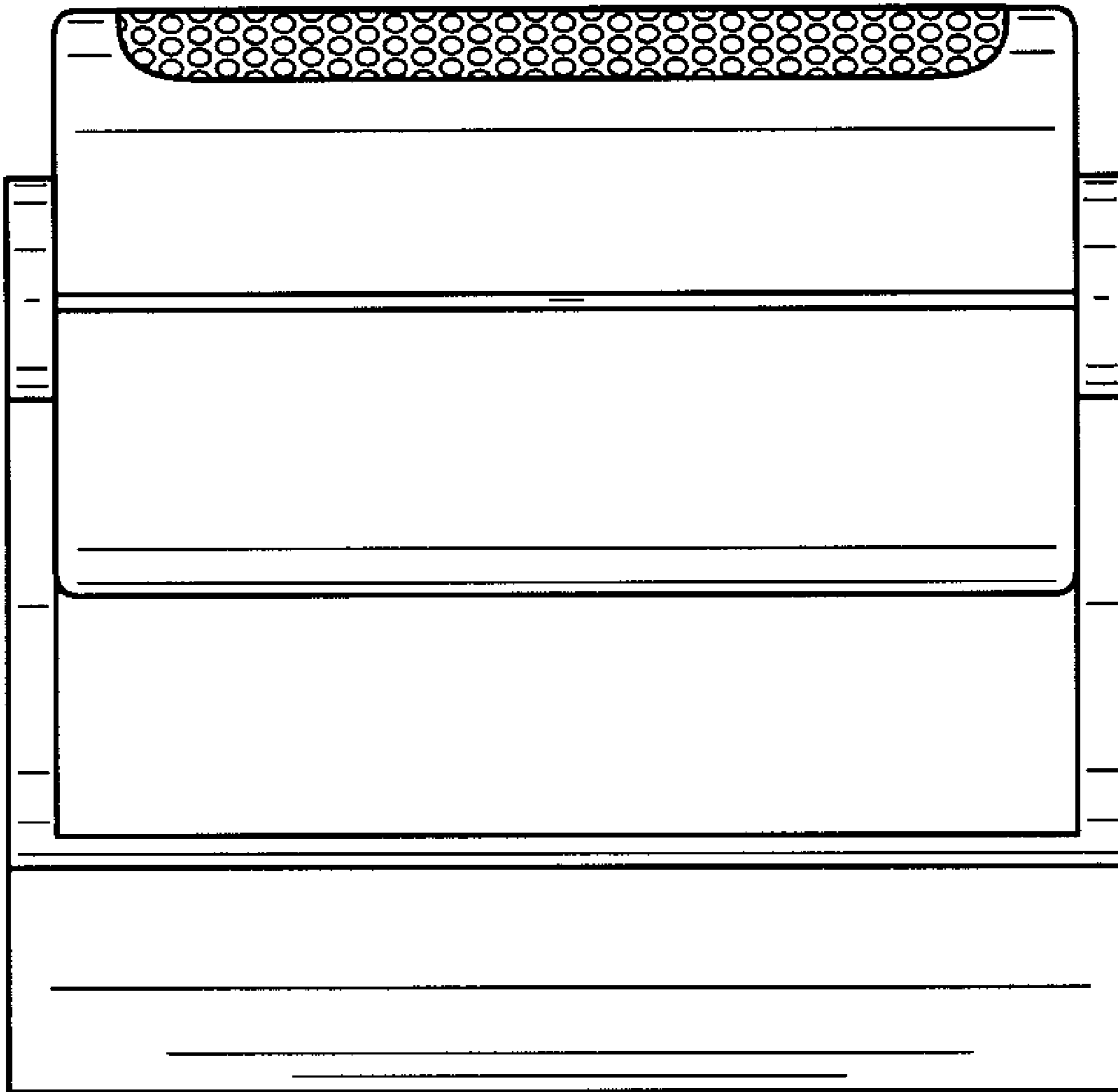

FIG. 6

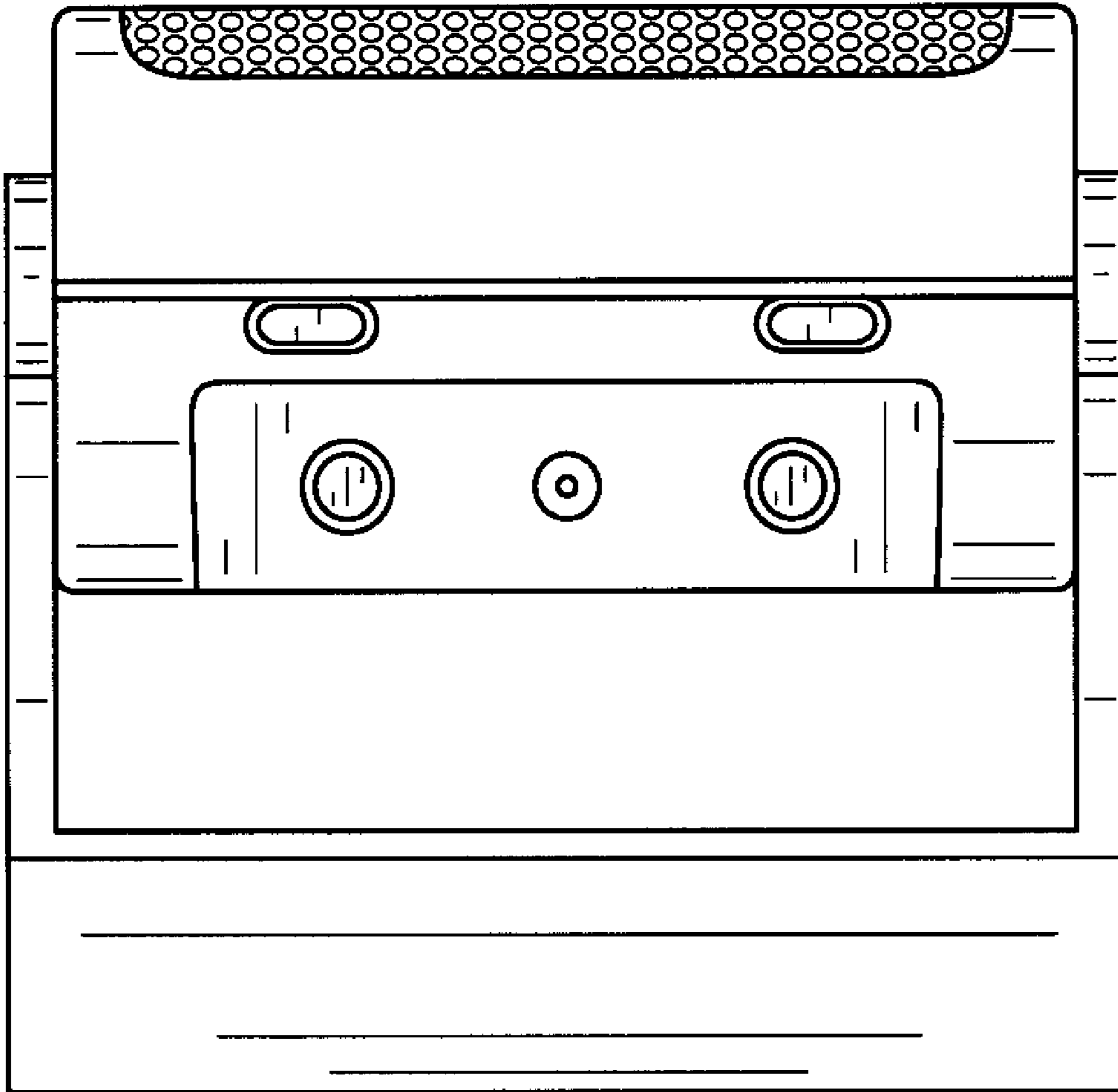

FIG. 7

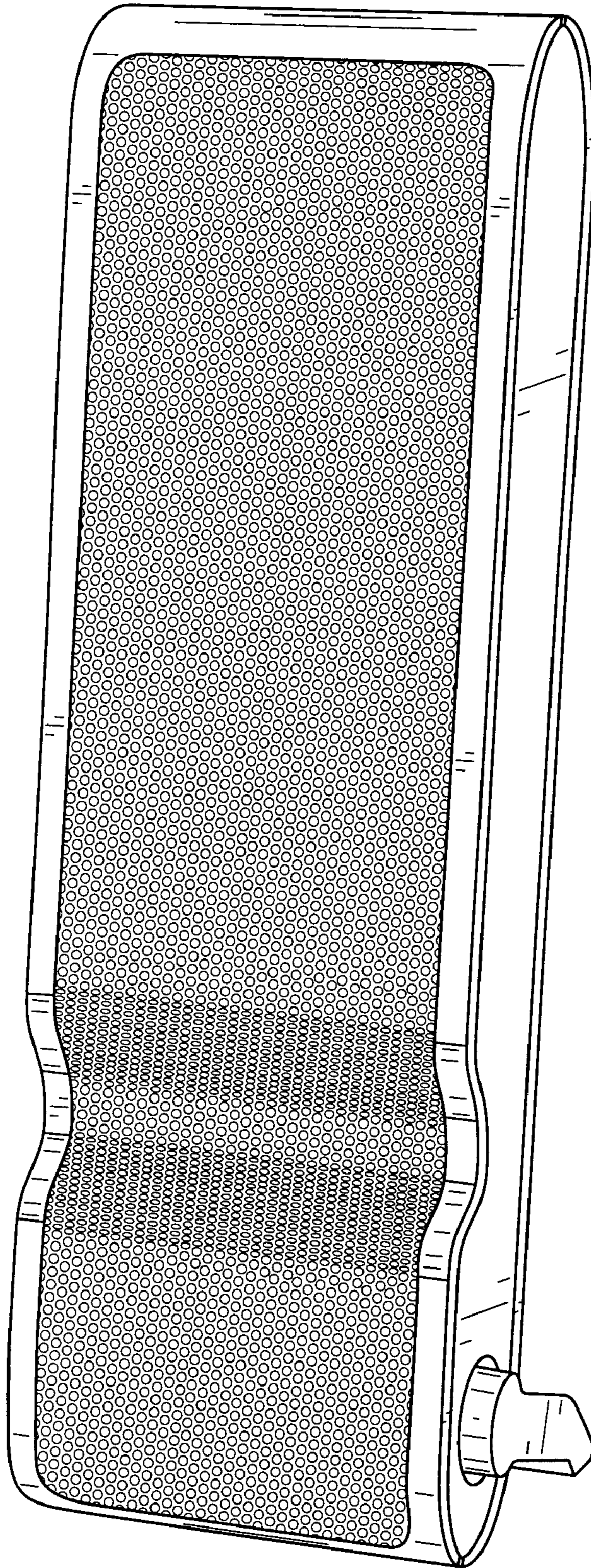

FIG. 8

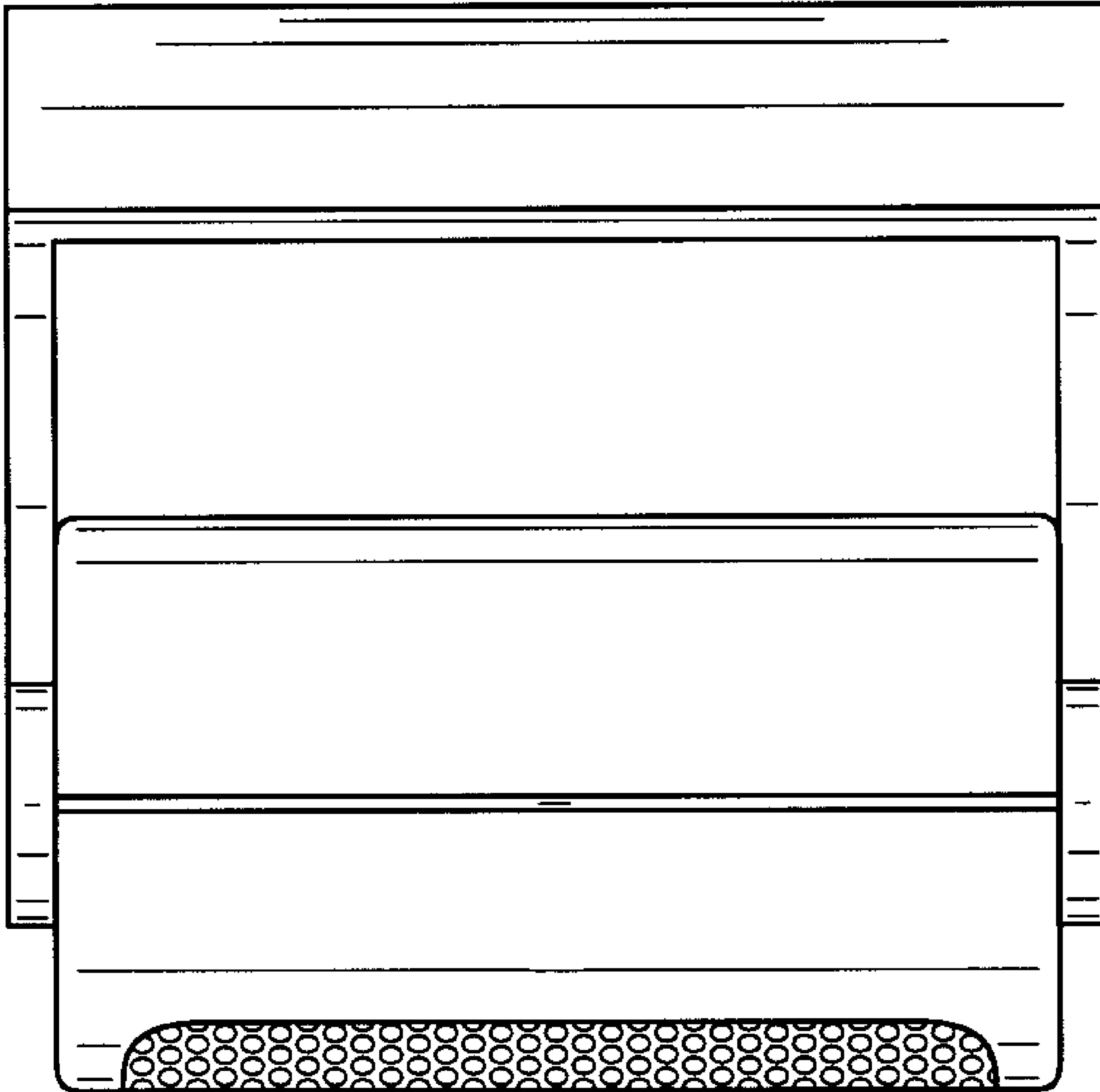

FIG. 9

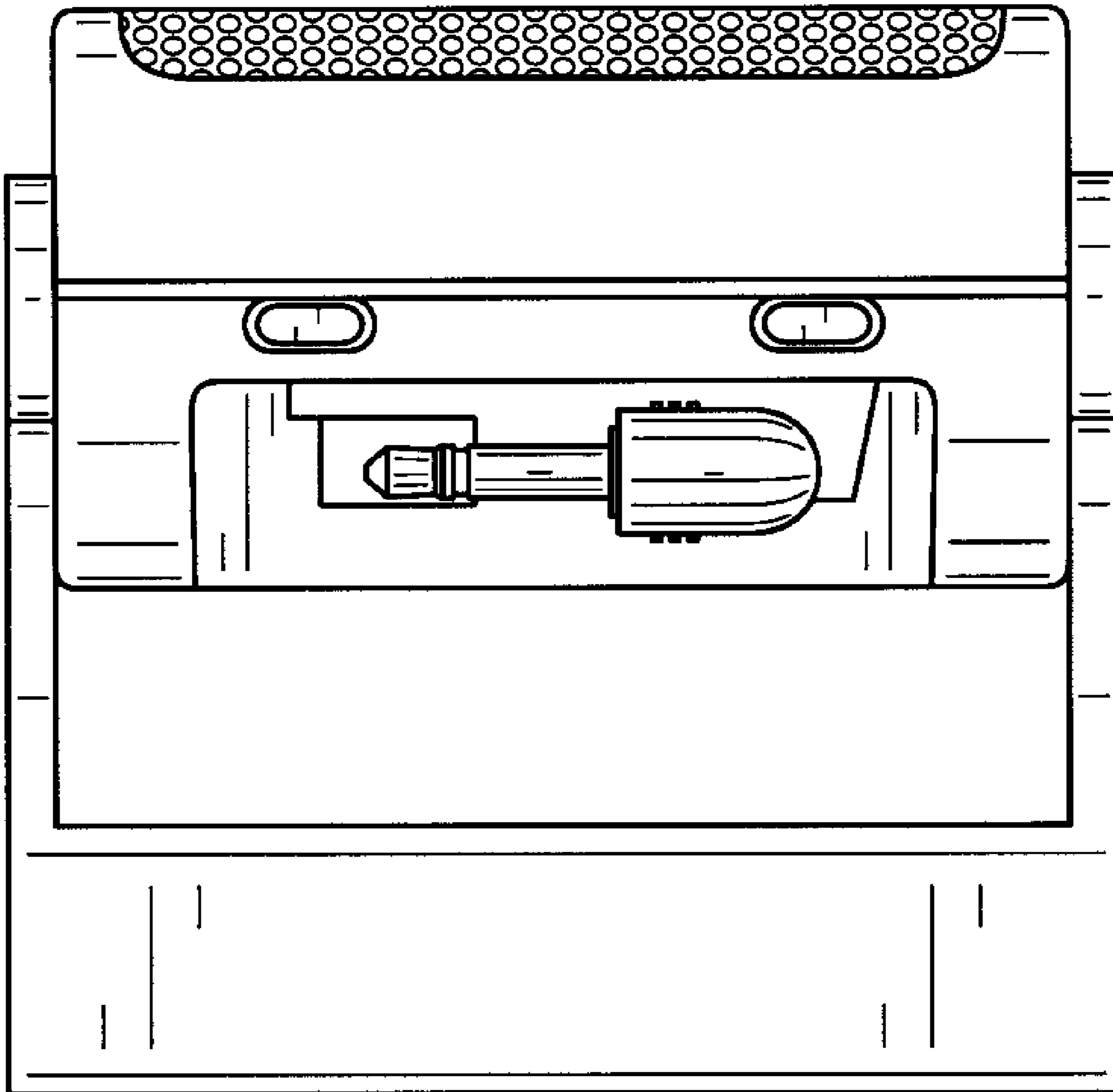

FIG. 10

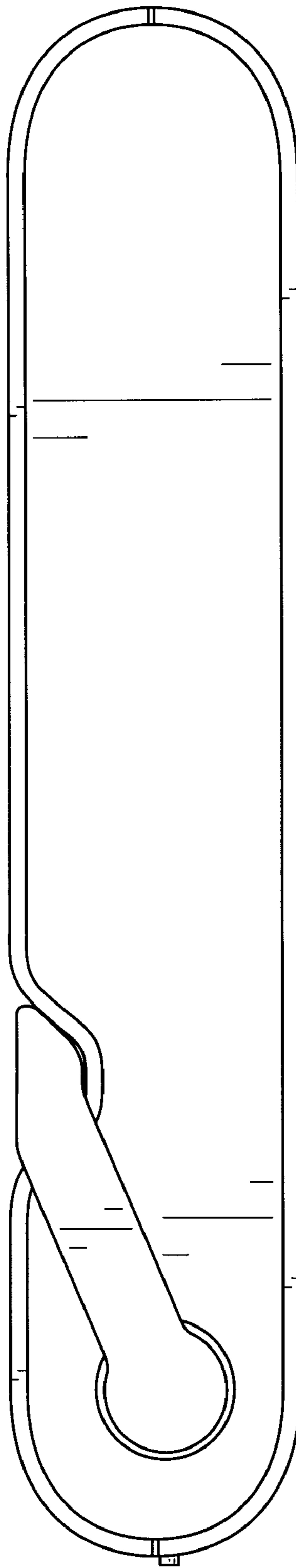

FIG. 11