

US00D564490S

(12) **United States Design Patent**
Kim et al.

(10) **Patent No.:** **US D564,490 S**
(45) **Date of Patent:** **** Mar. 18, 2008**

(54) **CELLULAR PHONE**

(75) Inventors: **Kang-Moon Kim**, Seoul (KR); **Jin-Soo Kim**, Yongin (KR); **Young-Ju Yeo**, Seoul (KR); **Chang-Hwan Hwang**, Goyang-si (KR)

(73) Assignee: **Samsung Electronics Co., Ltd.**, Suwon-Si (KR)

(**) Term: **14 Years**

(21) Appl. No.: **29/270,459**

(22) Filed: **Dec. 26, 2006**

(51) **LOC (8) Cl.** **14-03**

(52) **U.S. Cl.** **D14/138**

(58) **Field of Classification Search** D14/137,
D14/138, 147-151, 218, 144, 247, 248, 341-347;
455/550.1-90.3; 379/433.01-433.13; 361/814;
348/14.02

See application file for complete search history.

(56) **References Cited**

U.S. PATENT DOCUMENTS

- D466,096 S * 11/2002 Takada D14/138
- D495,695 S * 9/2004 Yugaya D14/346
- D528,532 S * 9/2006 Dimitriadis et al. D14/138
- 2005/0255897 A1* 11/2005 Lee et al. 455/575.4

OTHER PUBLICATIONS

- Qtek S100, announced 4th Quarter 2004 (online) (retrieved on Aug. 9, 2007) Retrieved from Internet URL <http://www.gsmarena.com>.*
- Motorola E680i, announced Mar. 2005 (online) (retrieved on Aug. 9, 2007) Retrieved from Internet URL <http://www.gsmarena.com>.*

* cited by examiner

Primary Examiner—Terry A Wallace

(74) *Attorney, Agent, or Firm*—Staas & Halsey LLP

(57) **CLAIM**

The ornamental design for a cellular phone, as shown and described.

DESCRIPTION

FIG. 1 is a perspective view of a cellular phone according to our new design;

FIG. 2 is a front elevational view thereof;

FIG. 3 is a rear elevational view thereof;

FIG. 4 is a left side elevational view thereof;

FIG. 5 is a right side elevational view thereof;

FIG. 6 is a top plan view thereof;

FIG. 7 is a bottom plan view thereof;

FIG. 8 is a front elevational view of the cellular phone according to our new design in a state in which the cellular phone is open to be used; and,

FIG. 9 is a rear elevational view of the cellular phone according to our new design in a state in which the cellular phone is open to be used.

The surface(s) or portion(s) of the article not shown in the drawing or described in the specification form(s) no part of the claimed design.

1 Claim, 9 Drawing Sheets

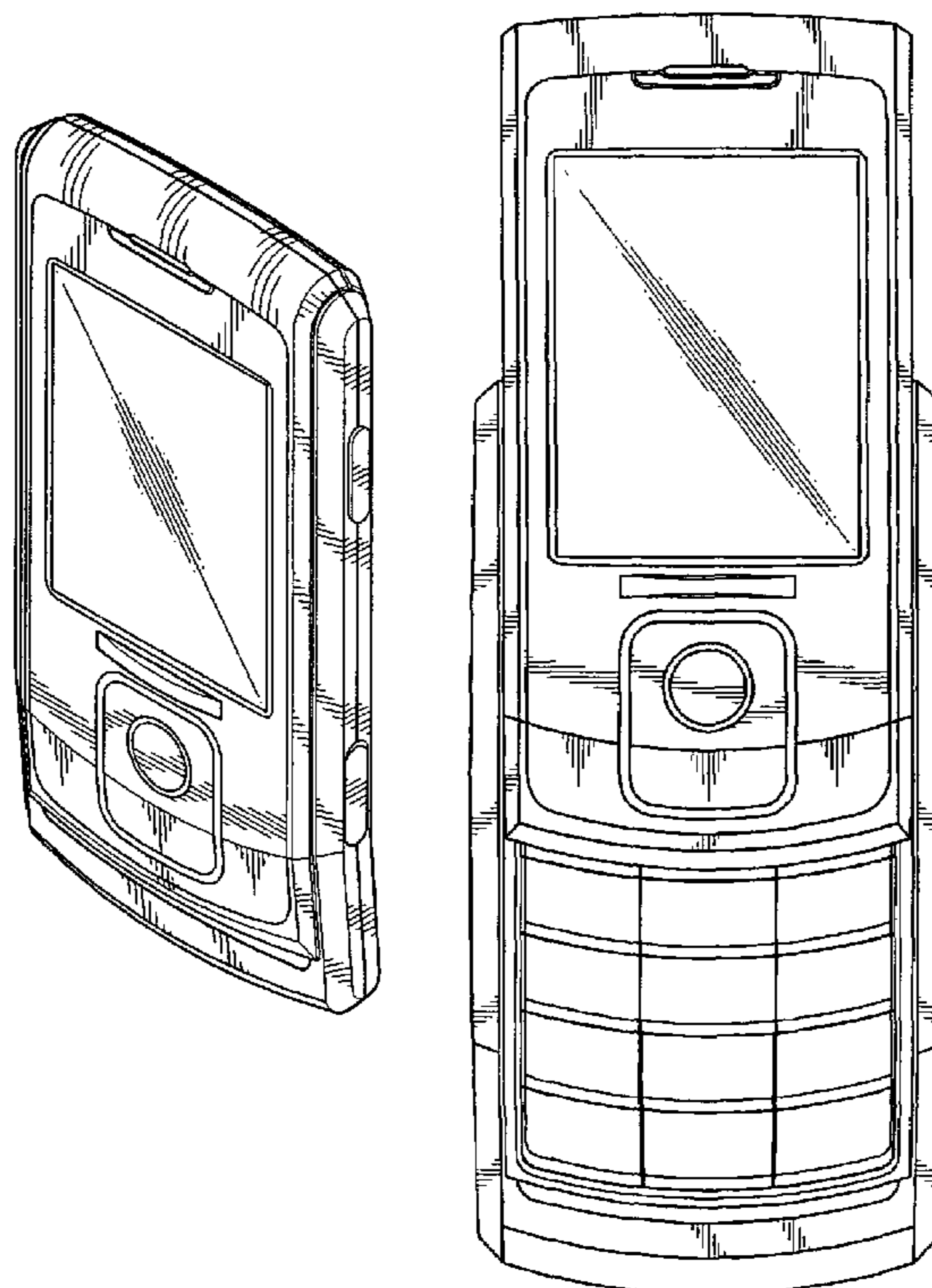

FIG. 1

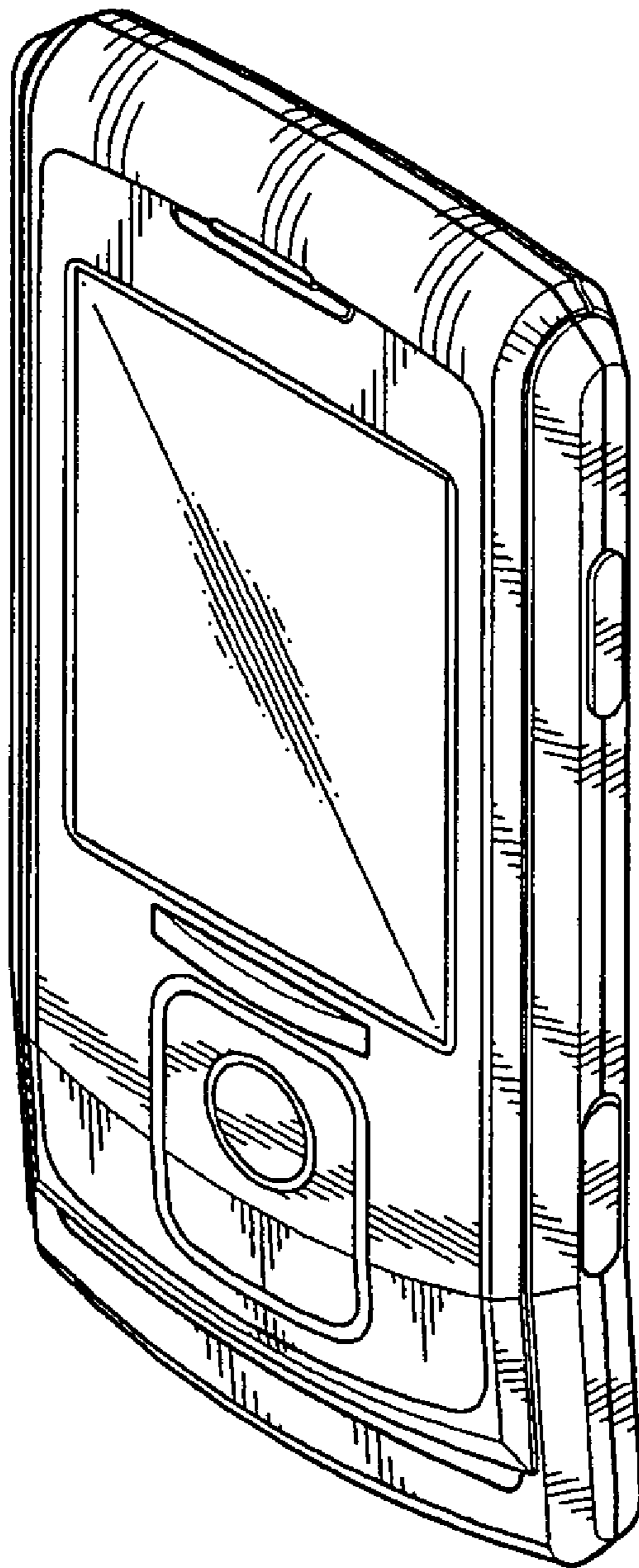

FIG. 2

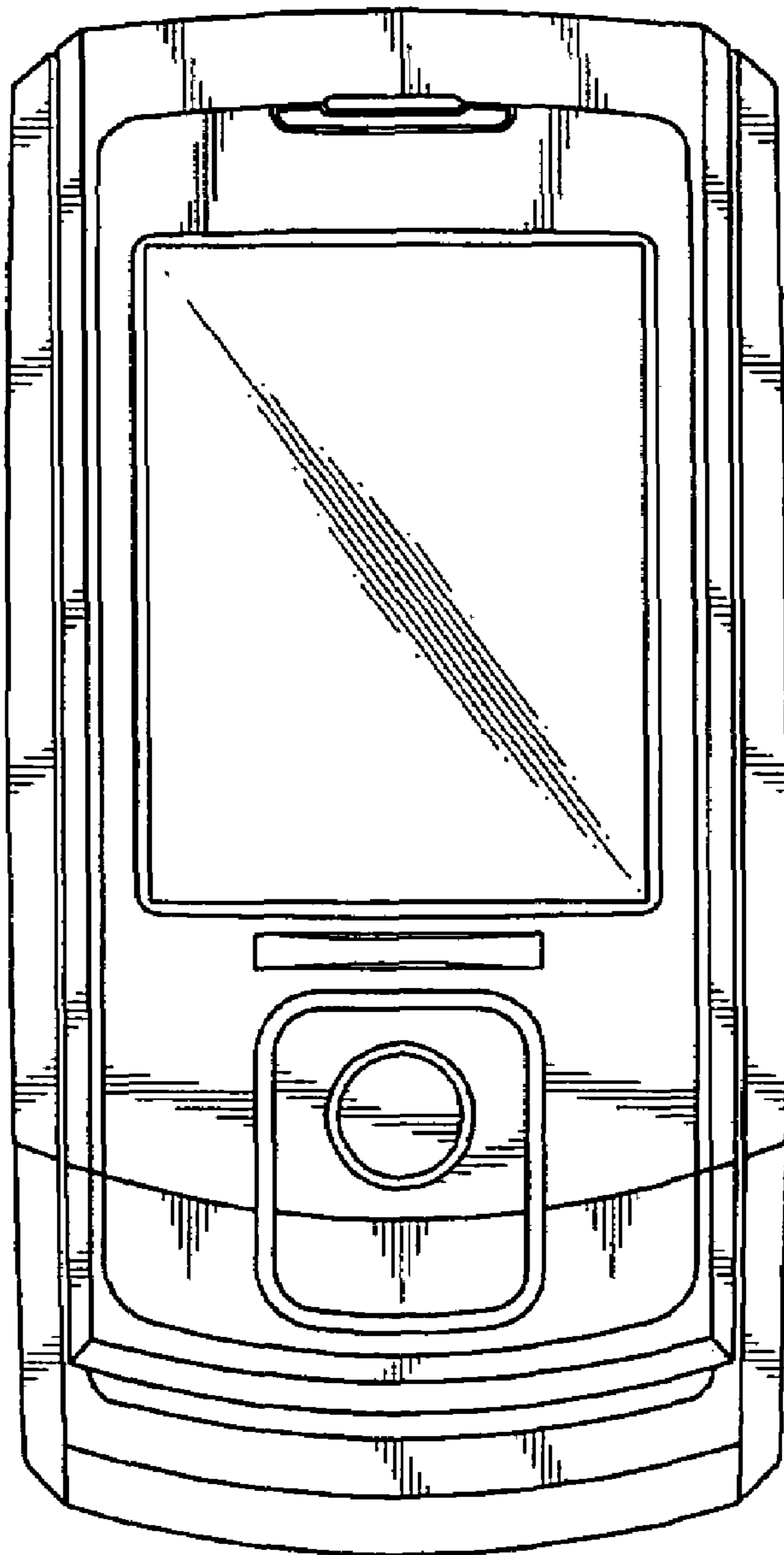

FIG. 3

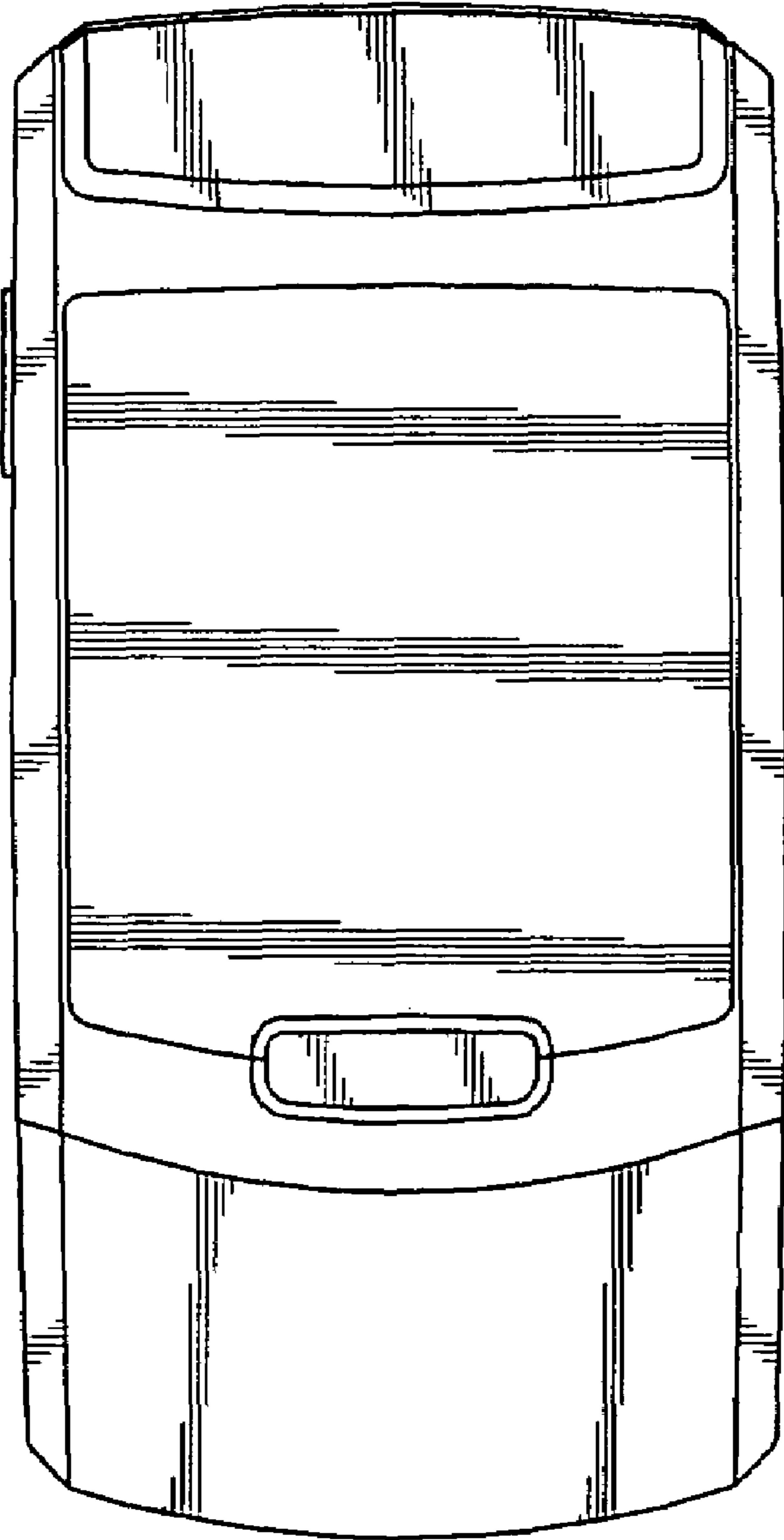

FIG. 4

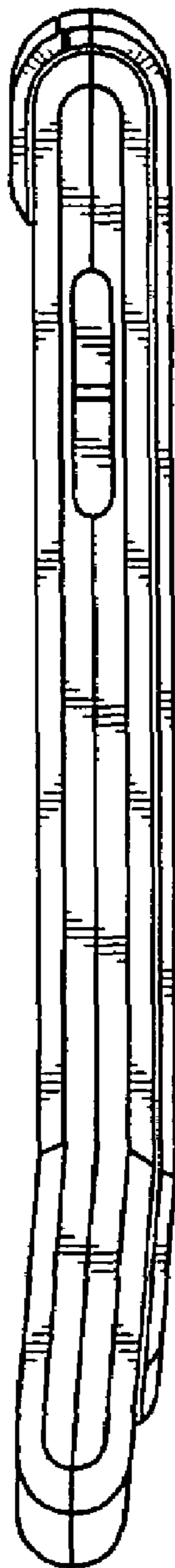

FIG. 5

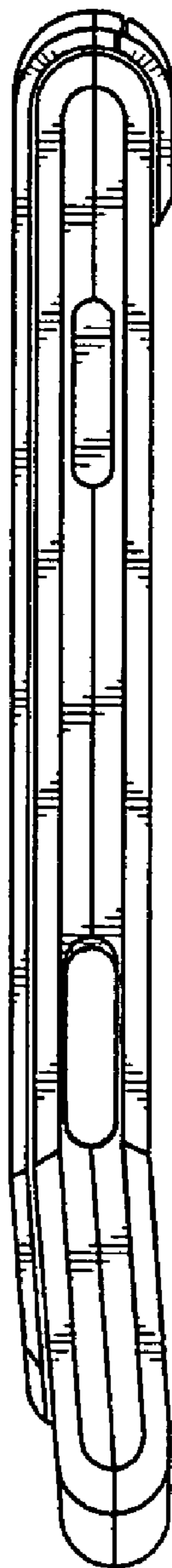

FIG. 6

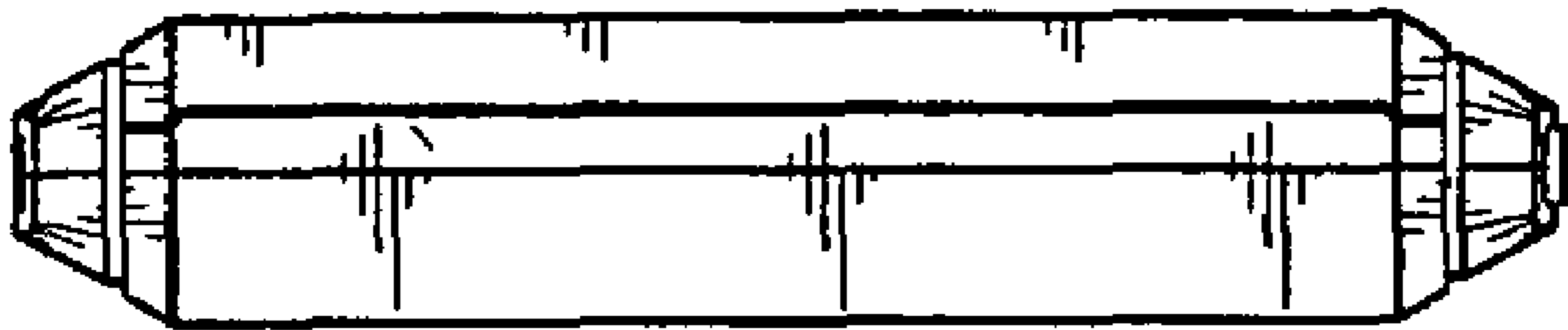

FIG. 7

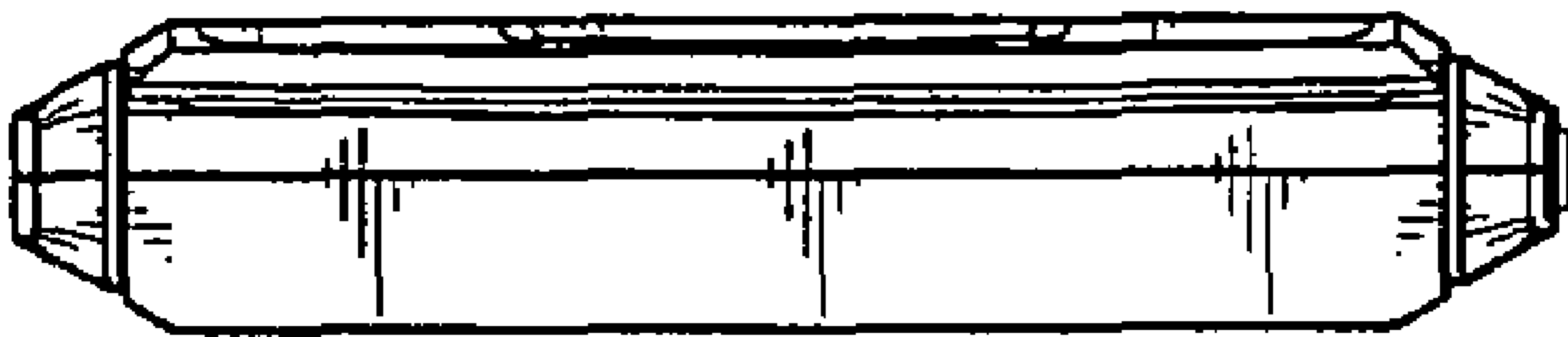

FIG. 8

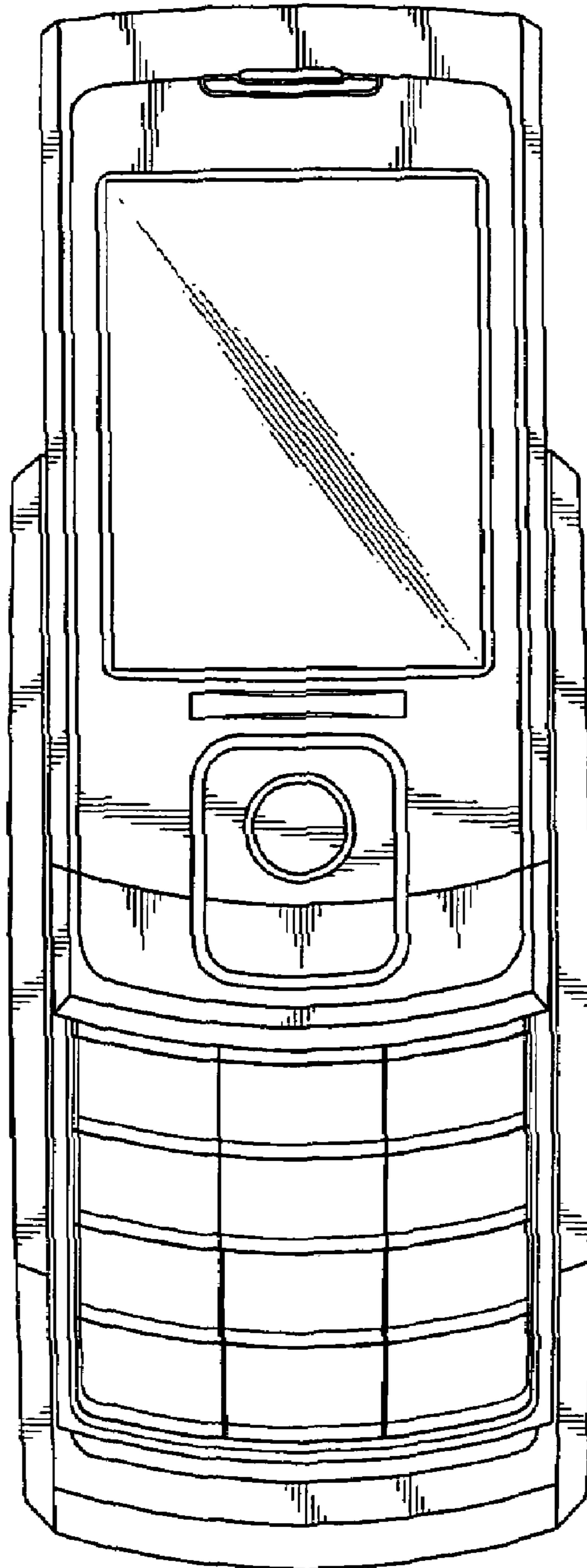

FIG. 9

