



US00D564468S

(12) **United States Design Patent**  
**Yoshimura**

(10) **Patent No.:** **US D564,468 S**

(45) **Date of Patent:** **\*\* Mar. 18, 2008**

(54) **TELEVISION APPARATUS**

(75) Inventor: **Satoshi Yoshimura**, Sagamihara (JP)

(73) Assignee: **Victor Company of Japan, Limited**,  
Yokohama-shi, Kanagawa (JP)

(\*\*) Term: **14 Years**

(21) Appl. No.: **29/274,065**

(22) Filed: **Mar. 27, 2007**

(30) **Foreign Application Priority Data**

Sep. 29, 2006 (JP) ..... D2006-026308

(51) **LOC (8) Cl.** ..... **14-03**

(52) **U.S. Cl.** ..... **D14/126**

(58) **Field of Classification Search** ..... D14/125-134,  
D14/239, 371, 136, 374-377; 312/7.2; 348/836,  
348/838, 180, 184, 325, 739; 341/12; 248/917-924,  
248/465; 345/104, 133, 156, 168, 87, 173;  
720/605, 669, 600, 655; 369/99, 197; 455/344-347  
See application file for complete search history.

(56) **References Cited**

**U.S. PATENT DOCUMENTS**

D419,977 S \* 2/2000 Chuo ..... D14/375

D534,138 S \* 12/2006 Lee et al. .... D14/126  
D548,708 S \* 8/2007 Park et al. .... D14/126

\* cited by examiner

*Primary Examiner*—Raphael Barkai

(74) *Attorney, Agent, or Firm*—The Nath Law Group; Jerald  
L. Meyer; Derek Richmond

(57) **CLAIM**

The ornamental design for a television apparatus, as shown  
and described.

**DESCRIPTION**

FIG. 1 is a perspective view of a television apparatus;

FIG. 2 is a rear perspective view thereof;

FIG. 3 is a front view thereof;

FIG. 4 is a rear view thereof;

FIG. 5 is a right side view thereof, a left side view being a  
mirror image of a right side view;

FIG. 6 is a top plan view thereof;

FIG. 7 is a bottom plan view thereof; and,

FIG. 8 is a top plan view thereof showing the article with its  
display panel rotated.

**1 Claim, 5 Drawing Sheets**

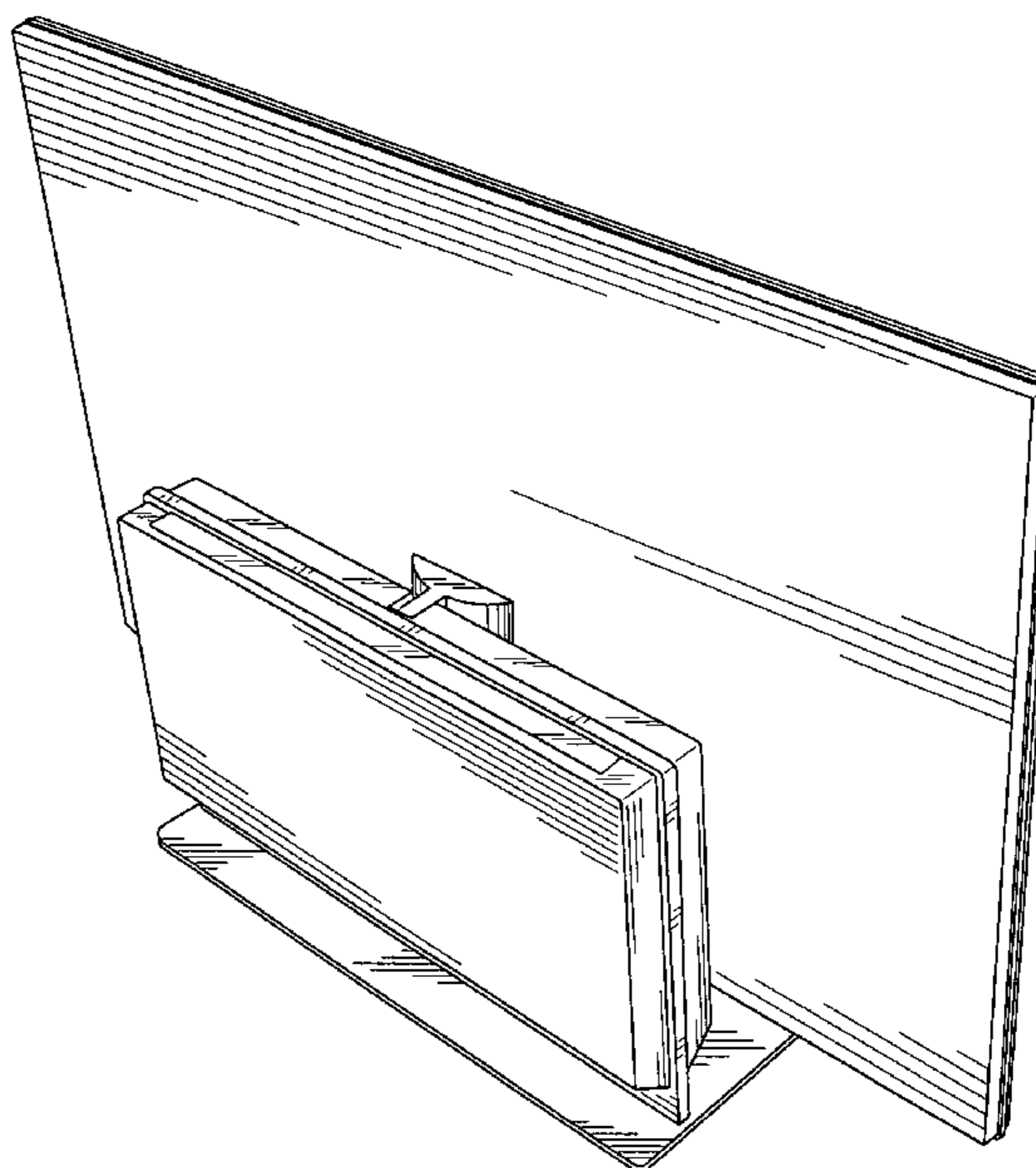
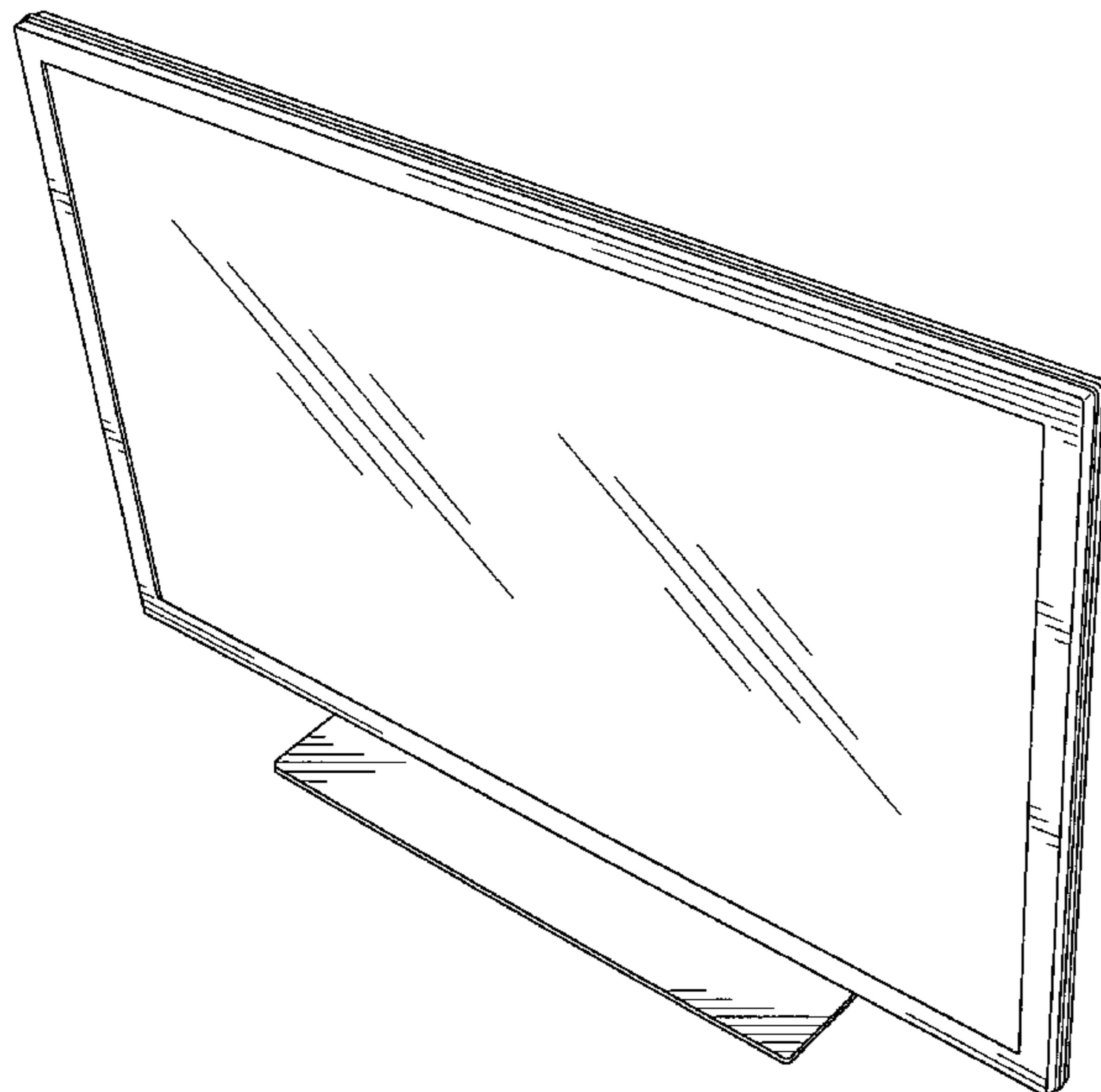

Fig. 1

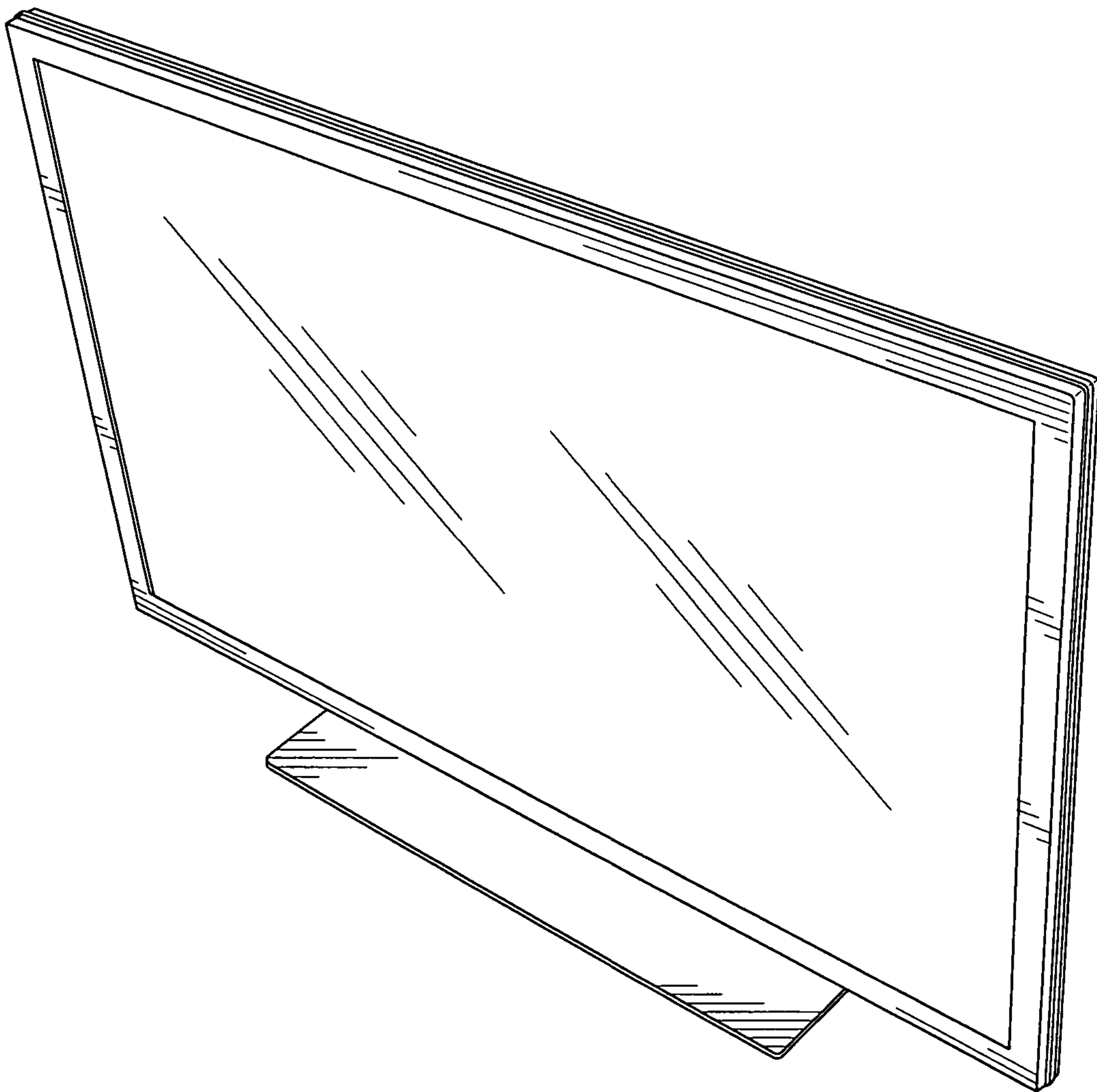

Fig.2

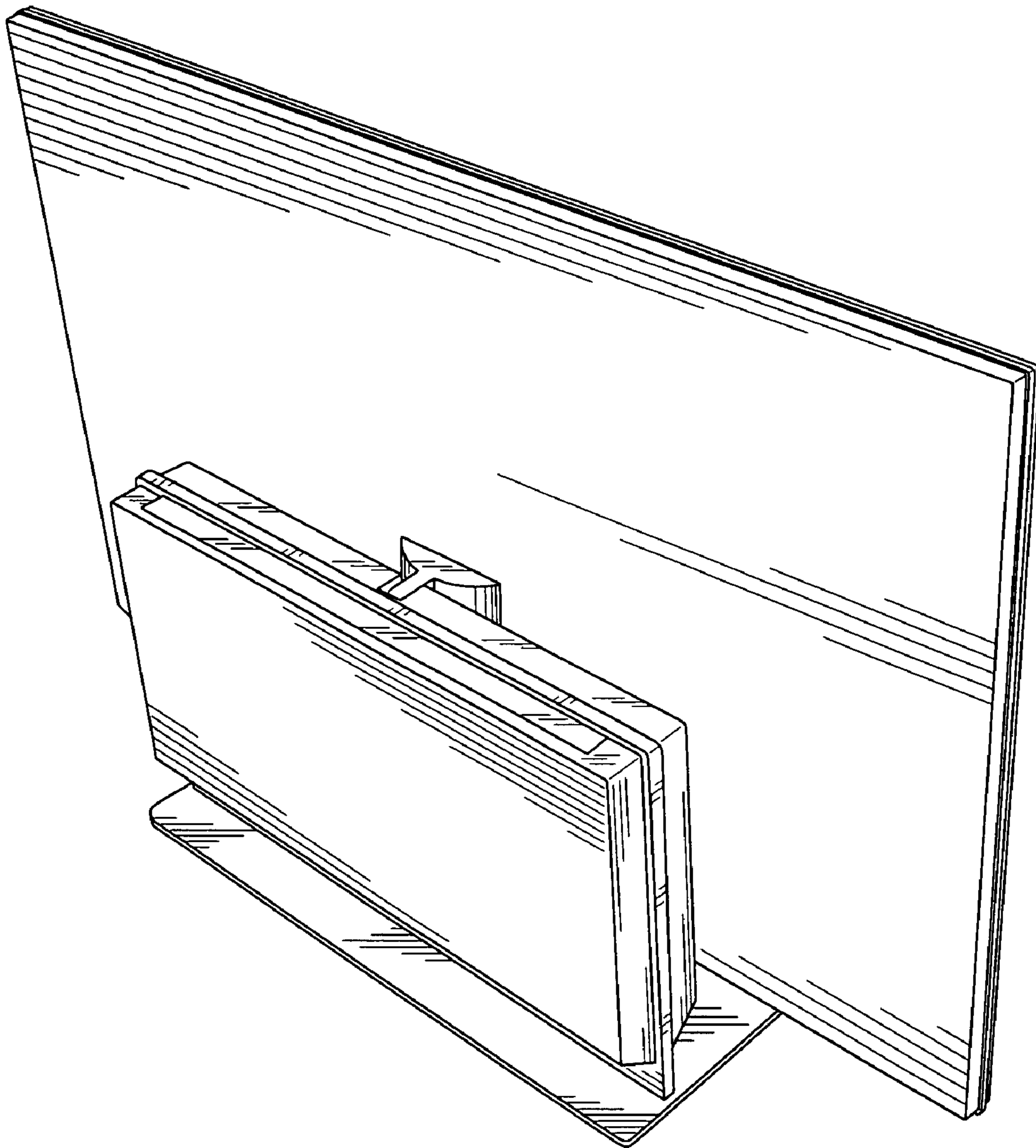

Fig.3

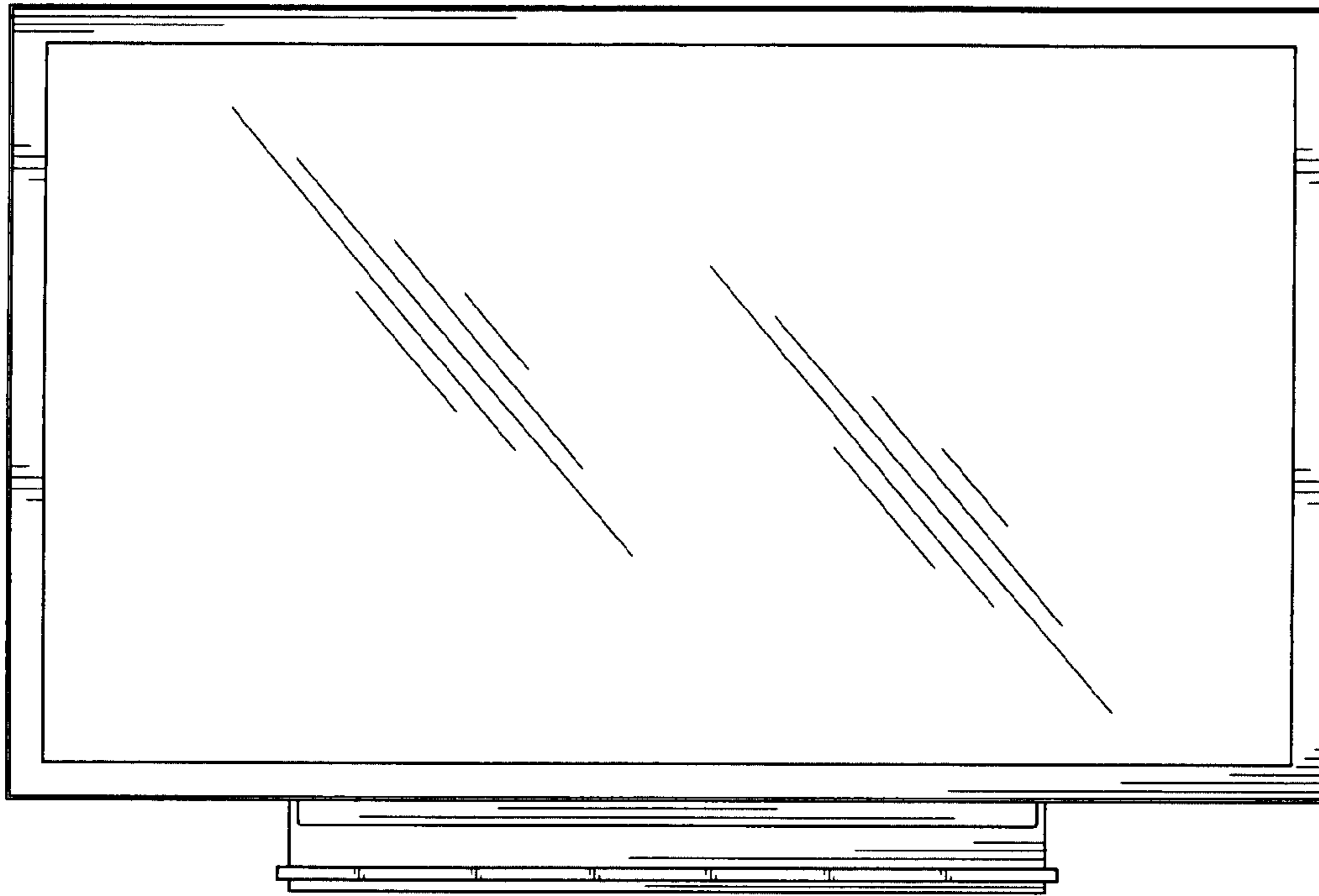

Fig.4

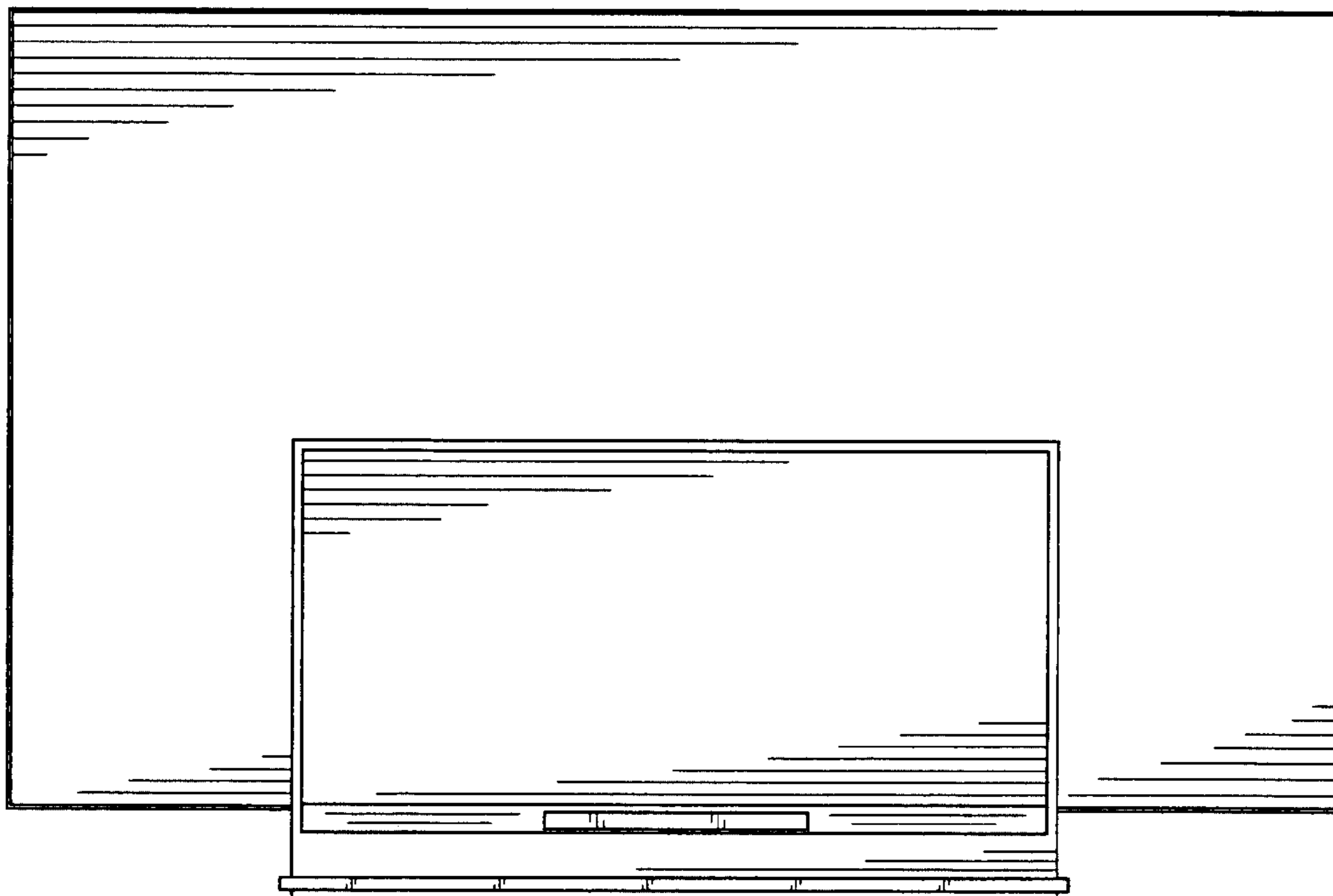

Fig.5

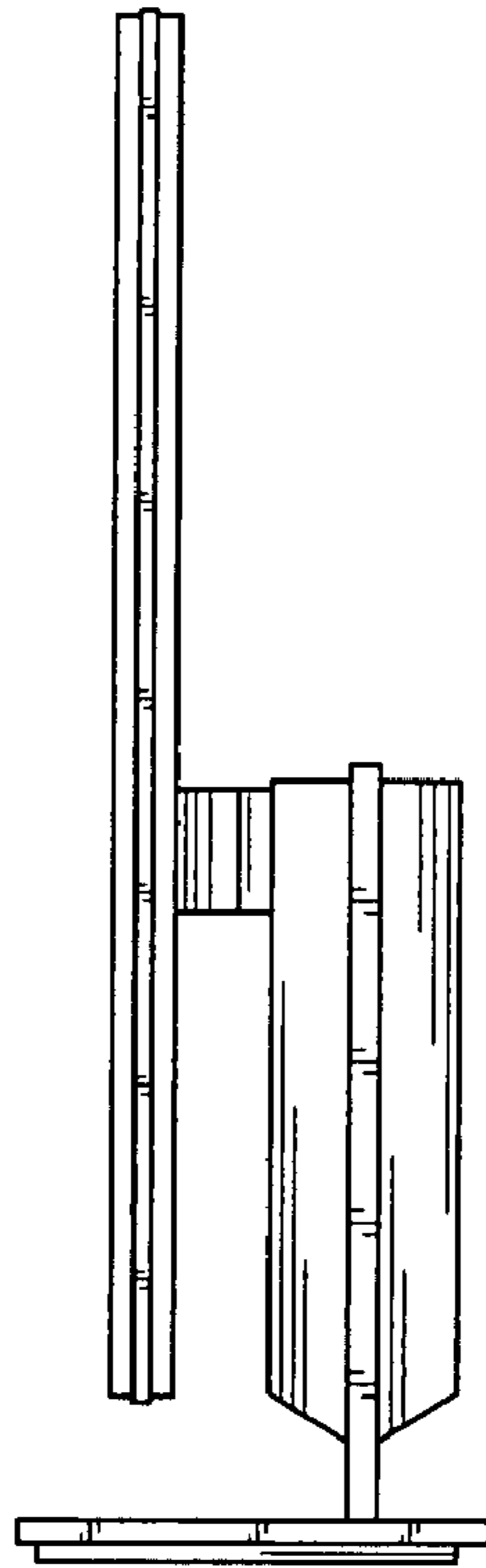

Fig.6

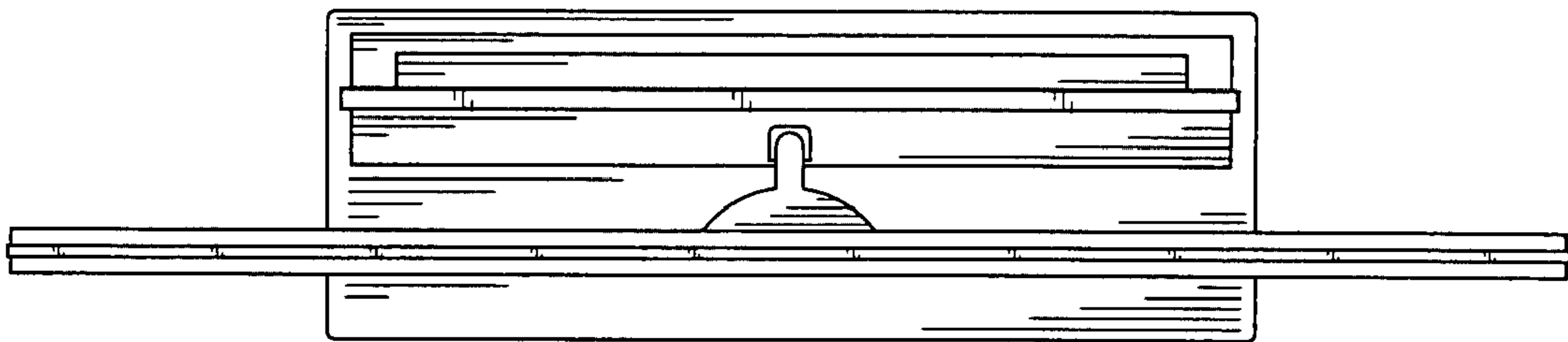

Fig.7

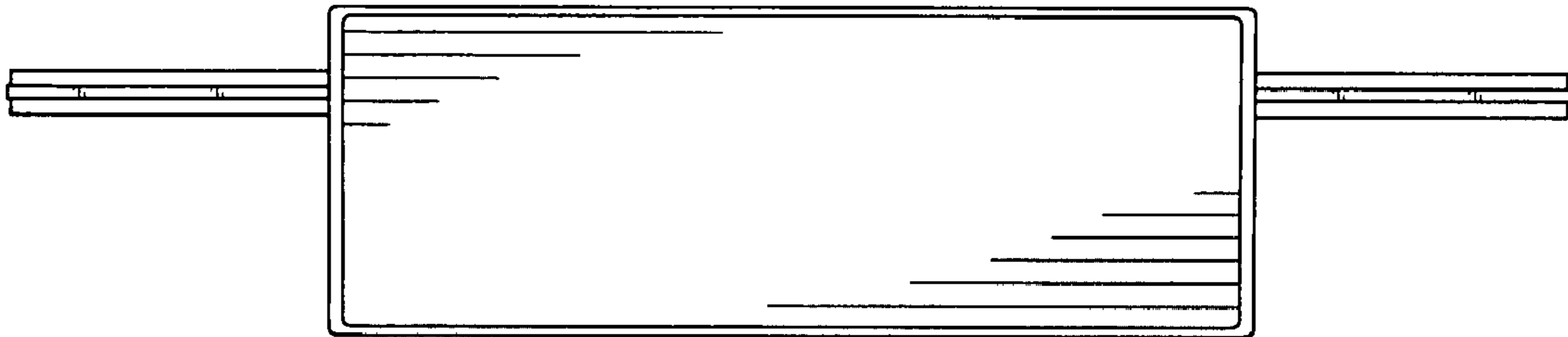

Fig.8

