



US00D564417S

(12) **United States Design Patent**
Uchiyama

(10) **Patent No.:** **US D564,417 S**
(45) **Date of Patent:** **** Mar. 18, 2008**

(54) **MOTORCYCLE**

(75) Inventor: **Shigeru Uchiyama**, Hamamatsu (JP)

(73) Assignee: **Suzuki Motor Corporation**,
Shizuoka-Pref. (JP)

(**) Term: **14 Years**

(21) Appl. No.: **29/275,669**

(22) Filed: **Jan. 3, 2007**

(30) **Foreign Application Priority Data**

Jul. 5, 2006 (JP) 2006-017697

(51) **LOC (8) Cl.** **12-11**

(52) **U.S. Cl.** **D12/110**

(58) **Field of Classification Search** D12/110;
180/219, 220, 225, 229

See application file for complete search history.

(56) **References Cited**

U.S. PATENT DOCUMENTS

D500,464 S * 1/2005 Ban et al. D12/110
D504,844 S * 5/2005 Sasanami D12/110
D535,216 S * 1/2007 Yoshiura D12/110

* cited by examiner

Primary Examiner—Cathron Brooks

Assistant Examiner—Linda Brooks

(74) *Attorney, Agent, or Firm*—Foley Hoag LLP

(57) **CLAIM**

The ornamental design for a motorcycle, as shown and described.

DESCRIPTION

FIG. 1 is a front view of a motorcycle showing my new design;

FIG. 2 is a rear elevational view thereof;

FIG. 3 is a right side elevational view thereof;

FIG. 4 is a left side elevational view thereof;

FIG. 5 is a top view thereof;

FIG. 6 is a bottom view thereof;

FIG. 7 is a front perspective view of the right side thereof;

FIG. 8 is a front perspective view of the left side thereof;

FIG. 9 is a rear perspective view of the right side thereof; and,

FIG. 10 is a rear perspective view of the left side thereof.

The broken lines shown are for illustrative purposes only and form no part of the claimed design.

1 Claim, 10 Drawing Sheets

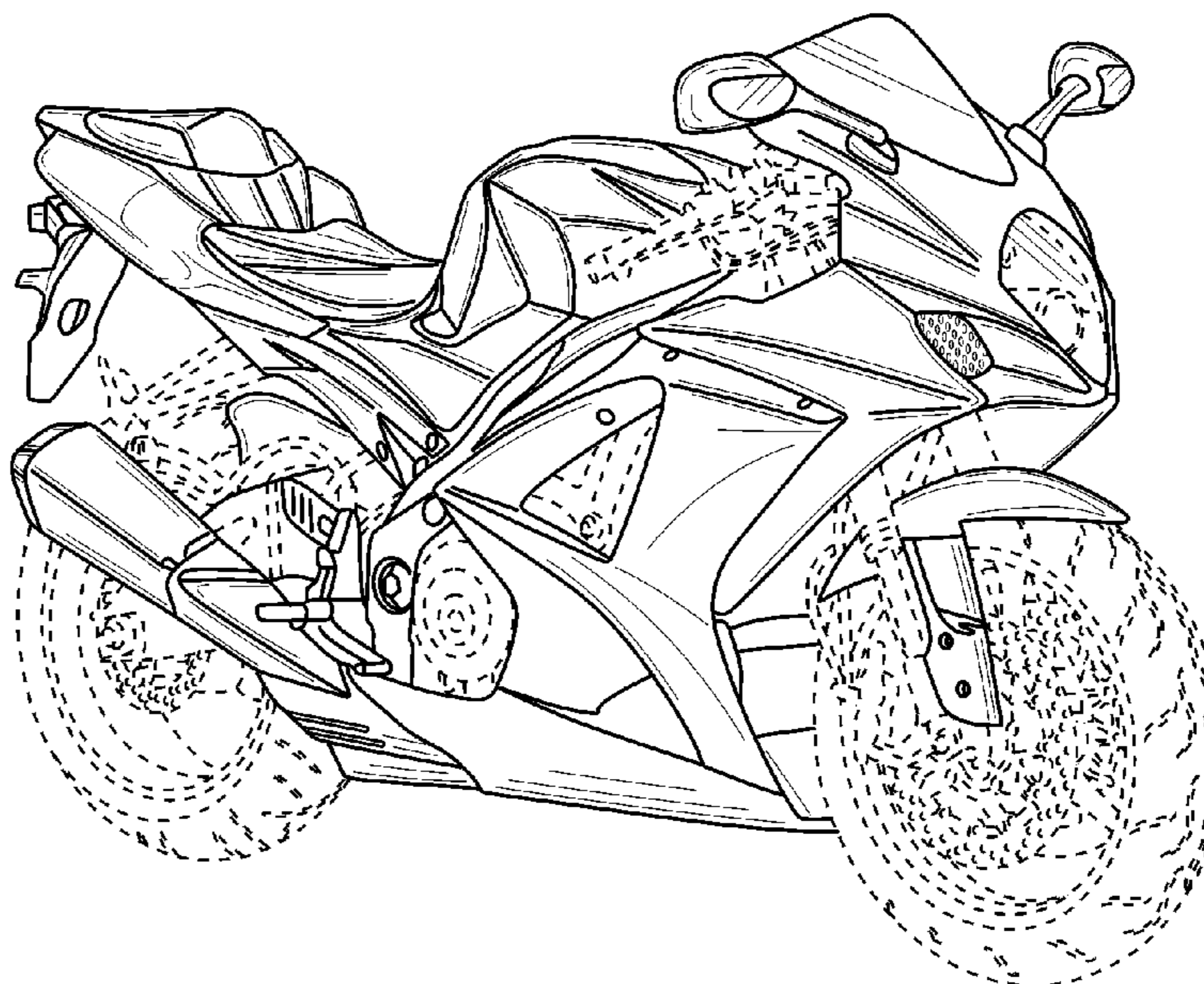
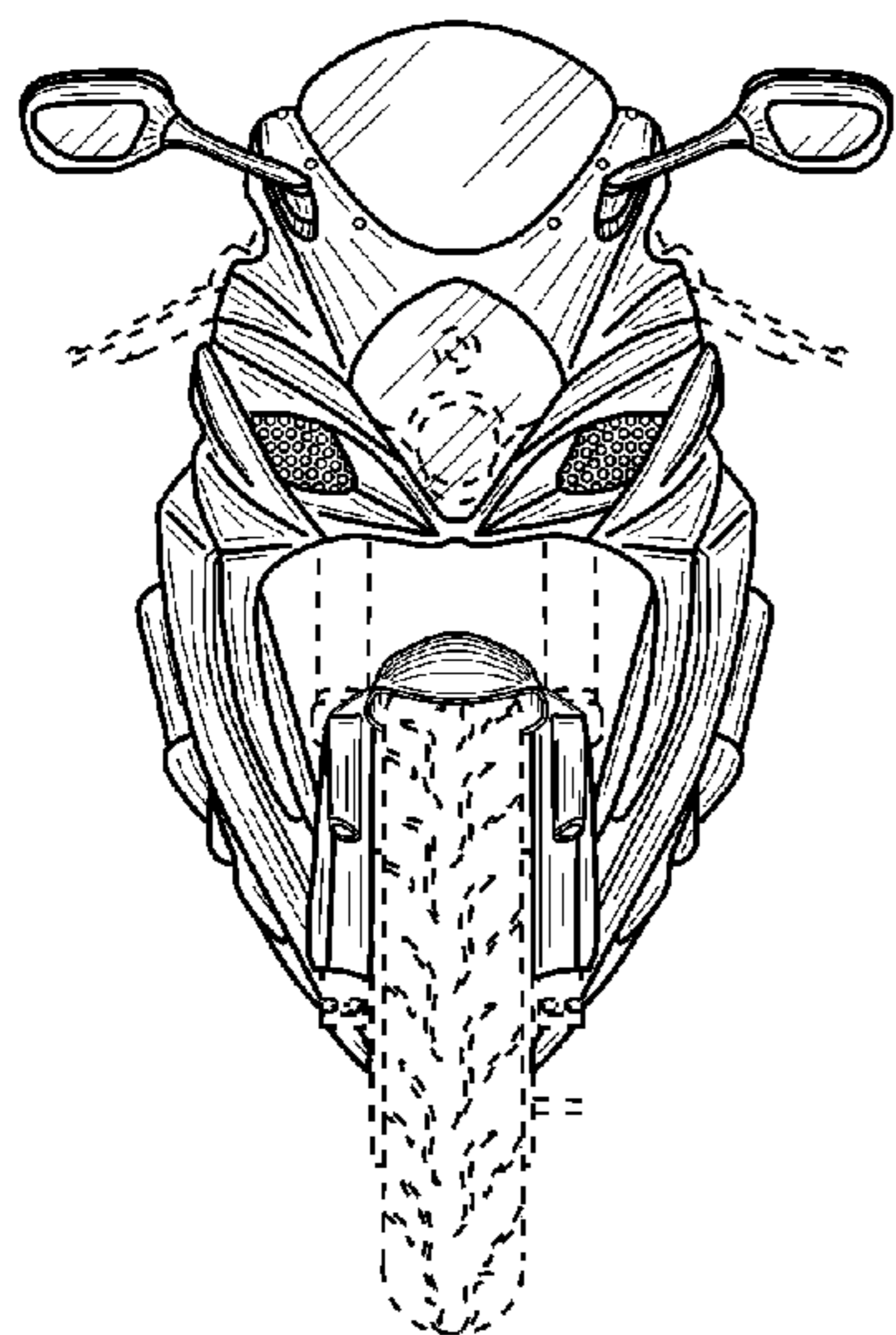

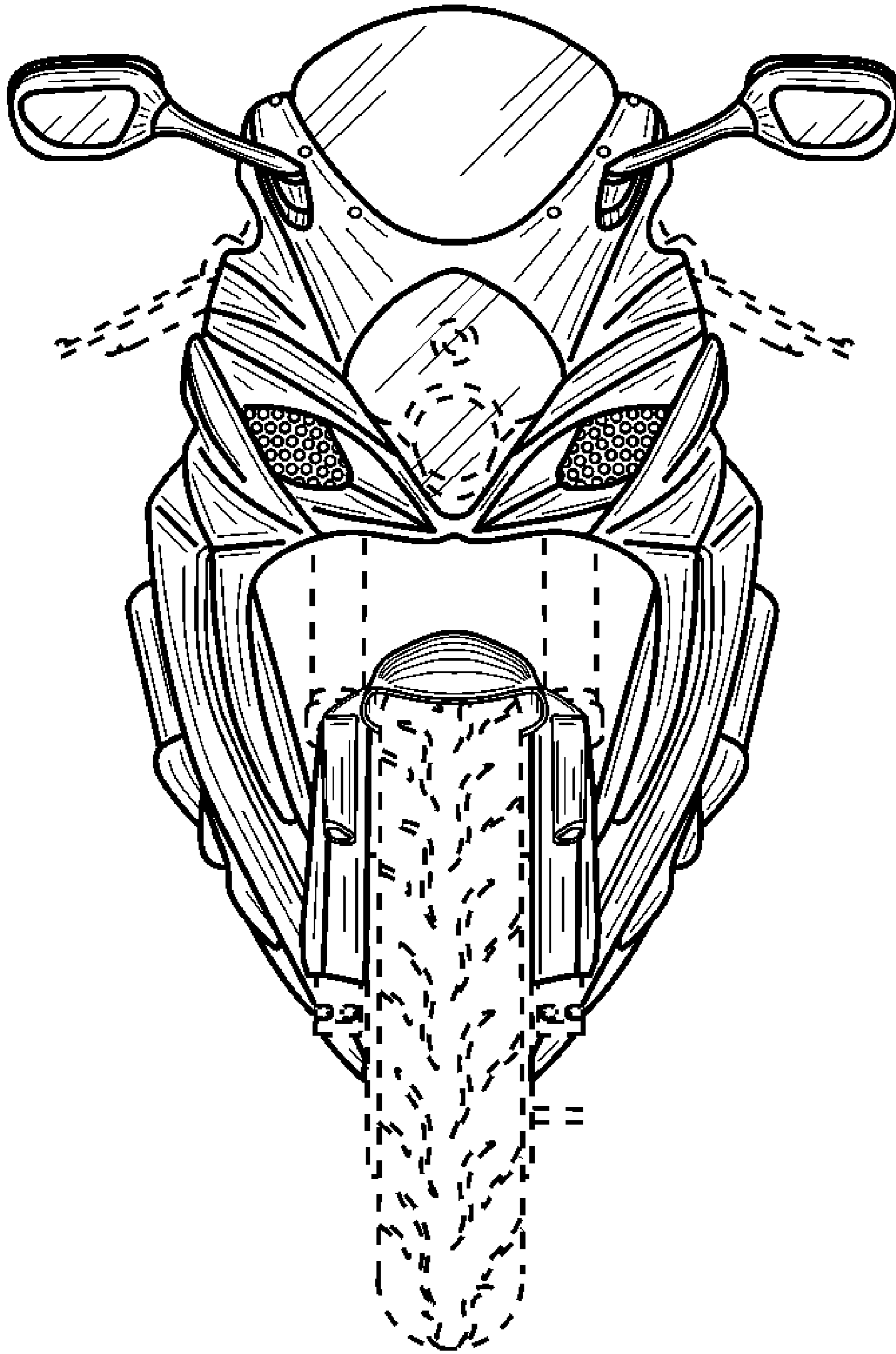

FIG. 1

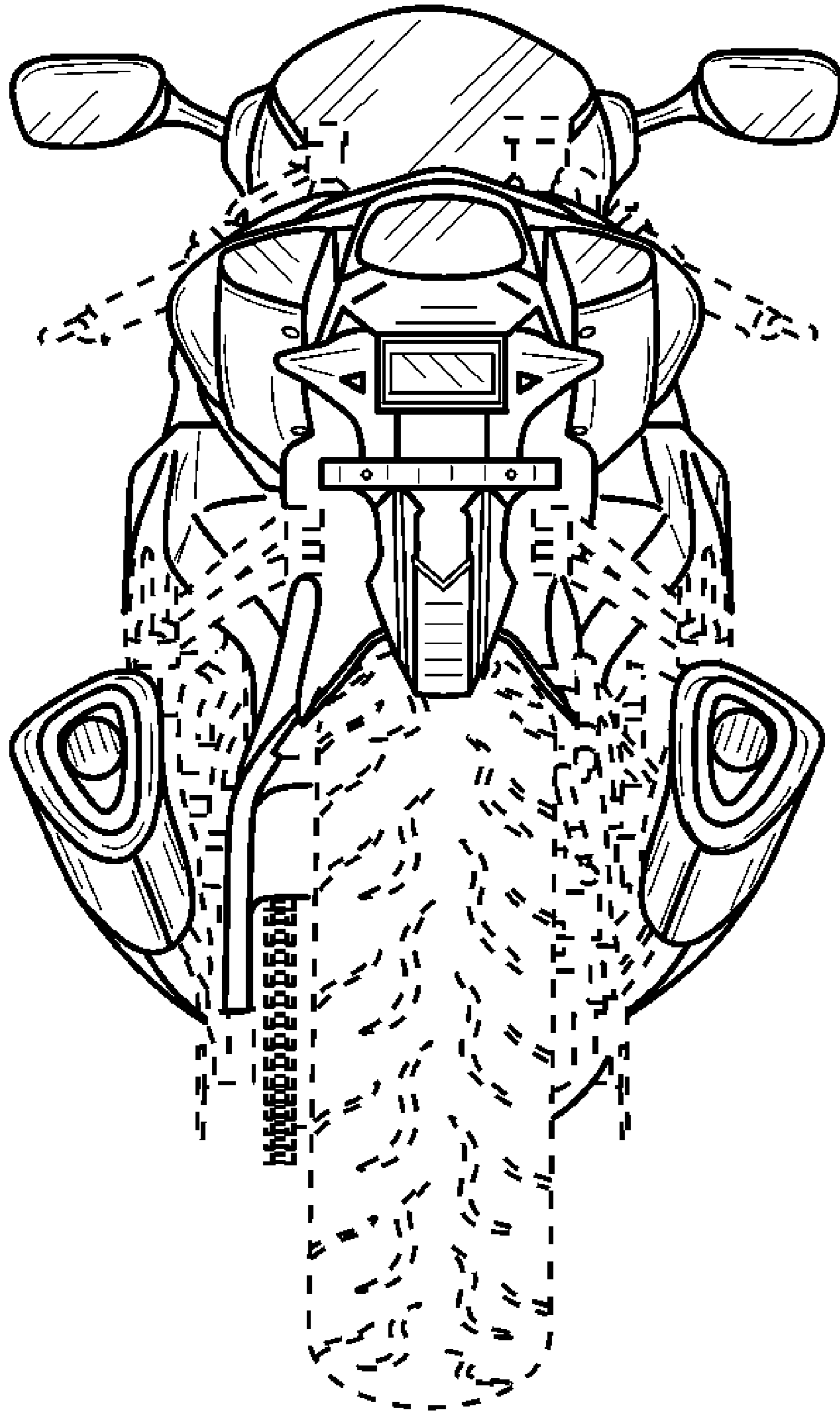

FIG. 2

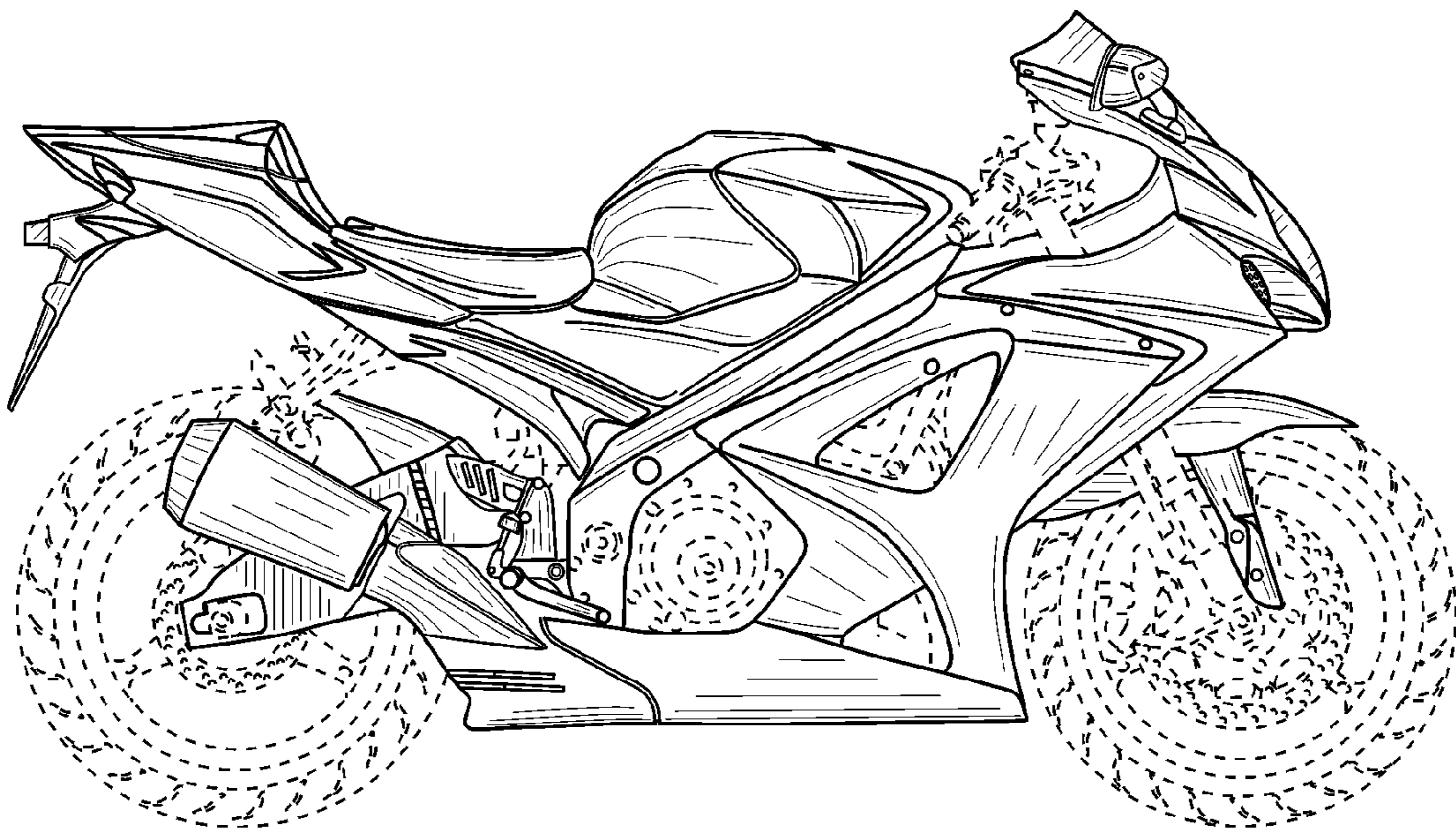

FIG. 3

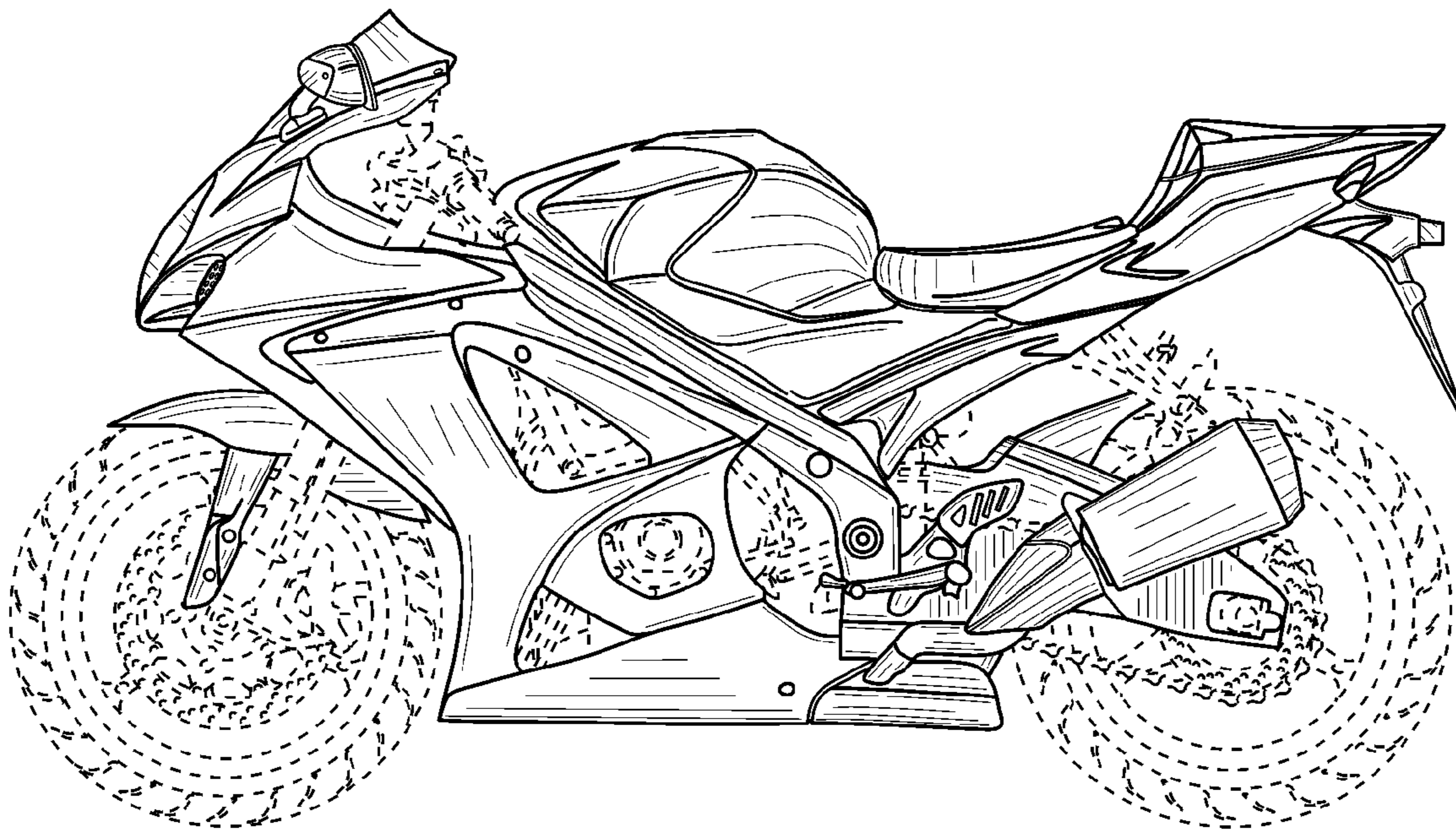

FIG. 4

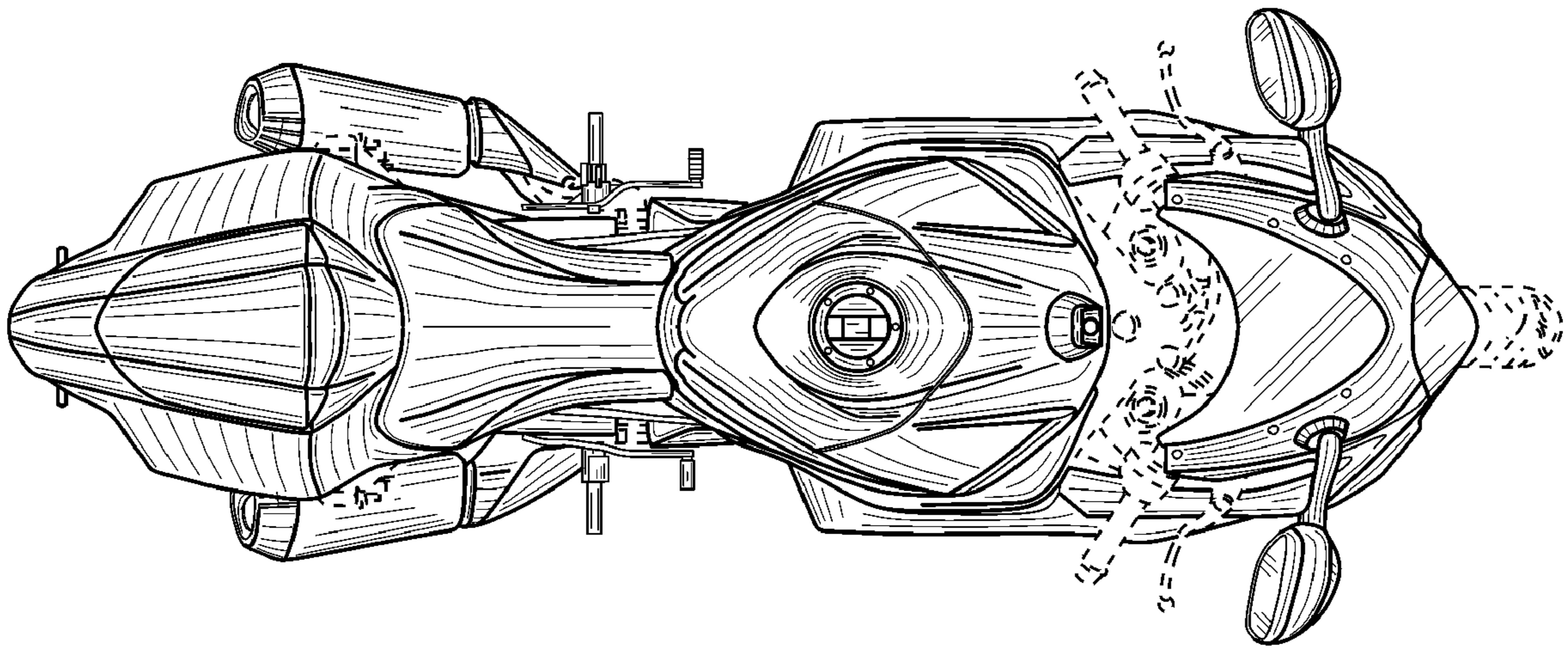

FIG. 5

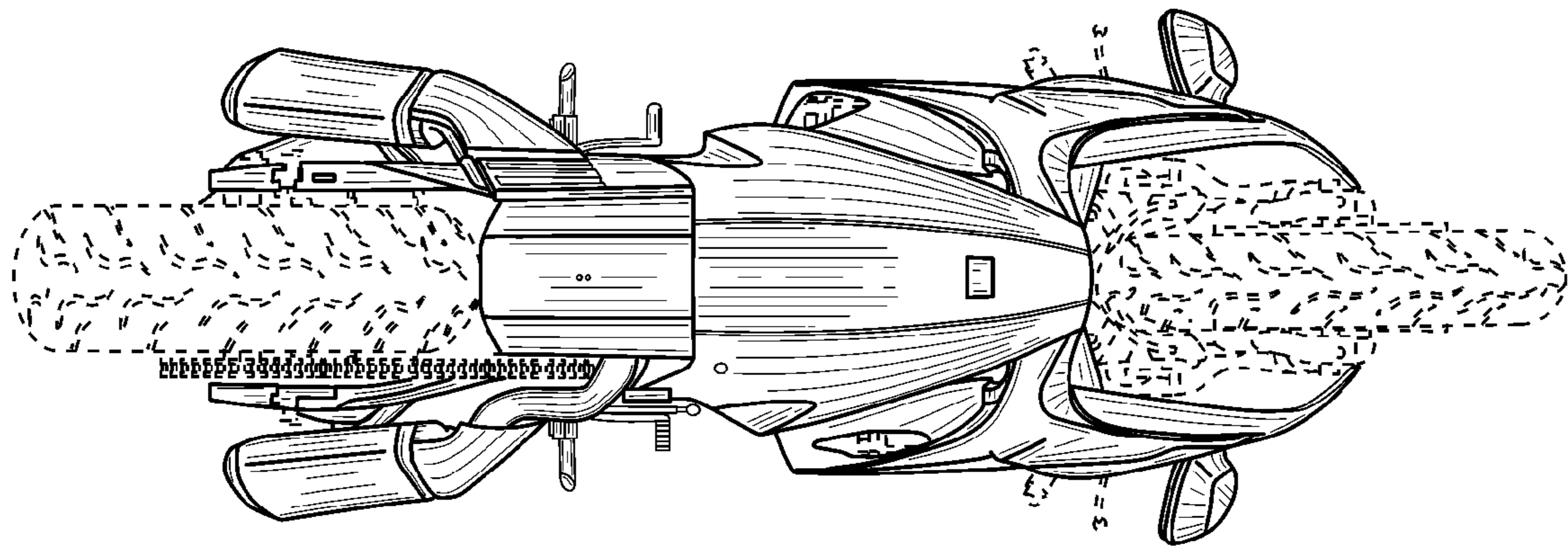

FIG. 6

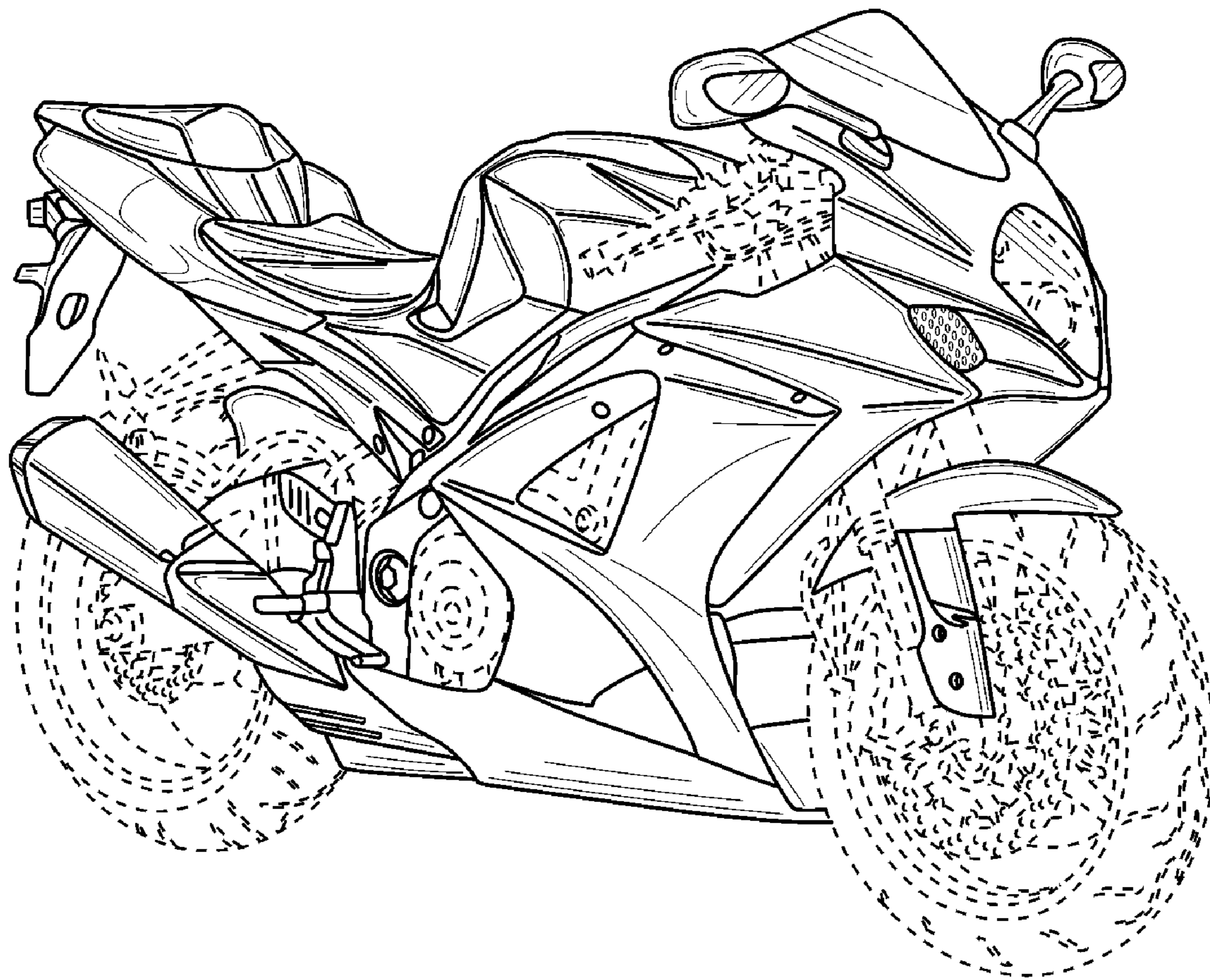

FIG. 7

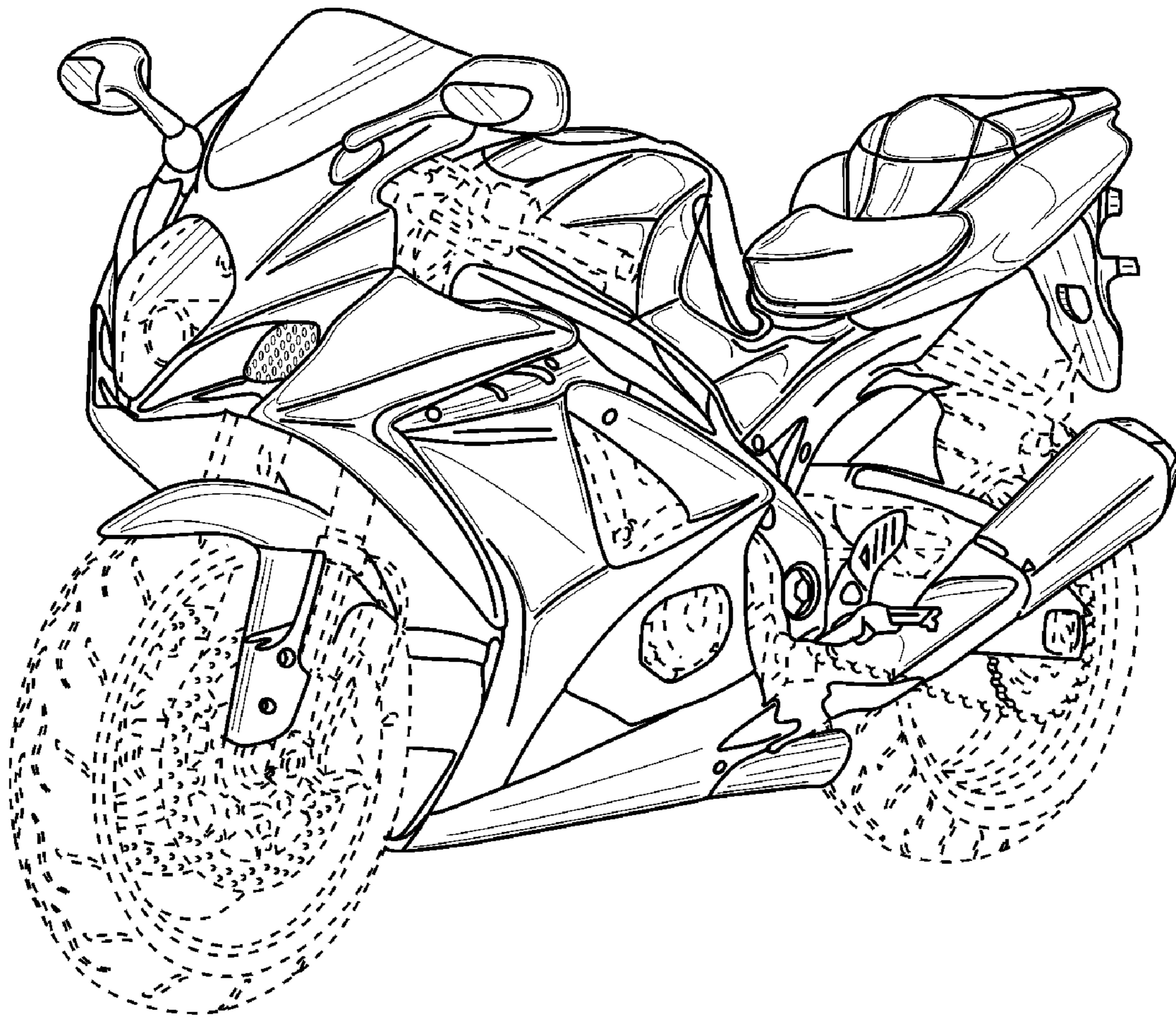

FIG. 8

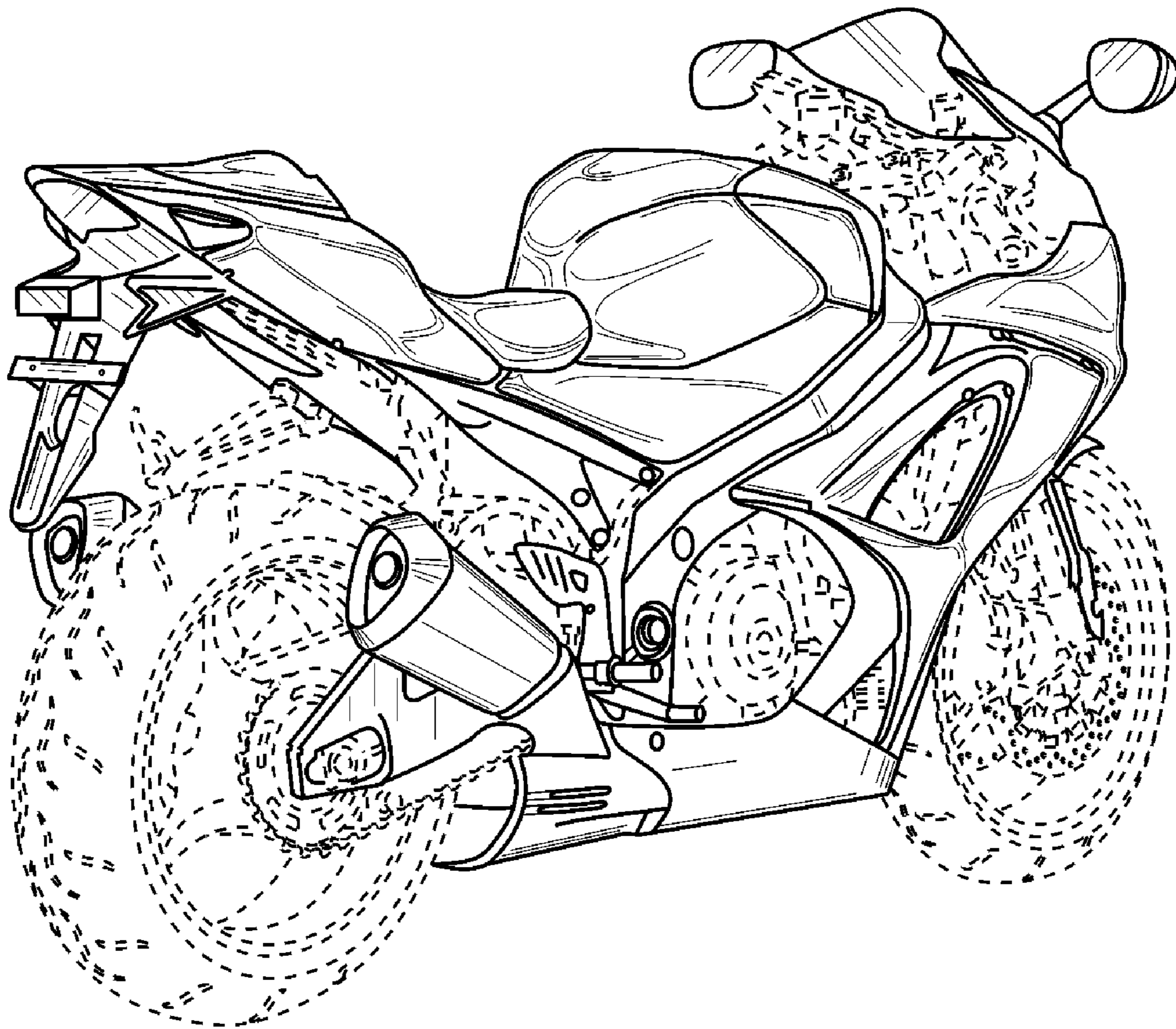

FIG. 9

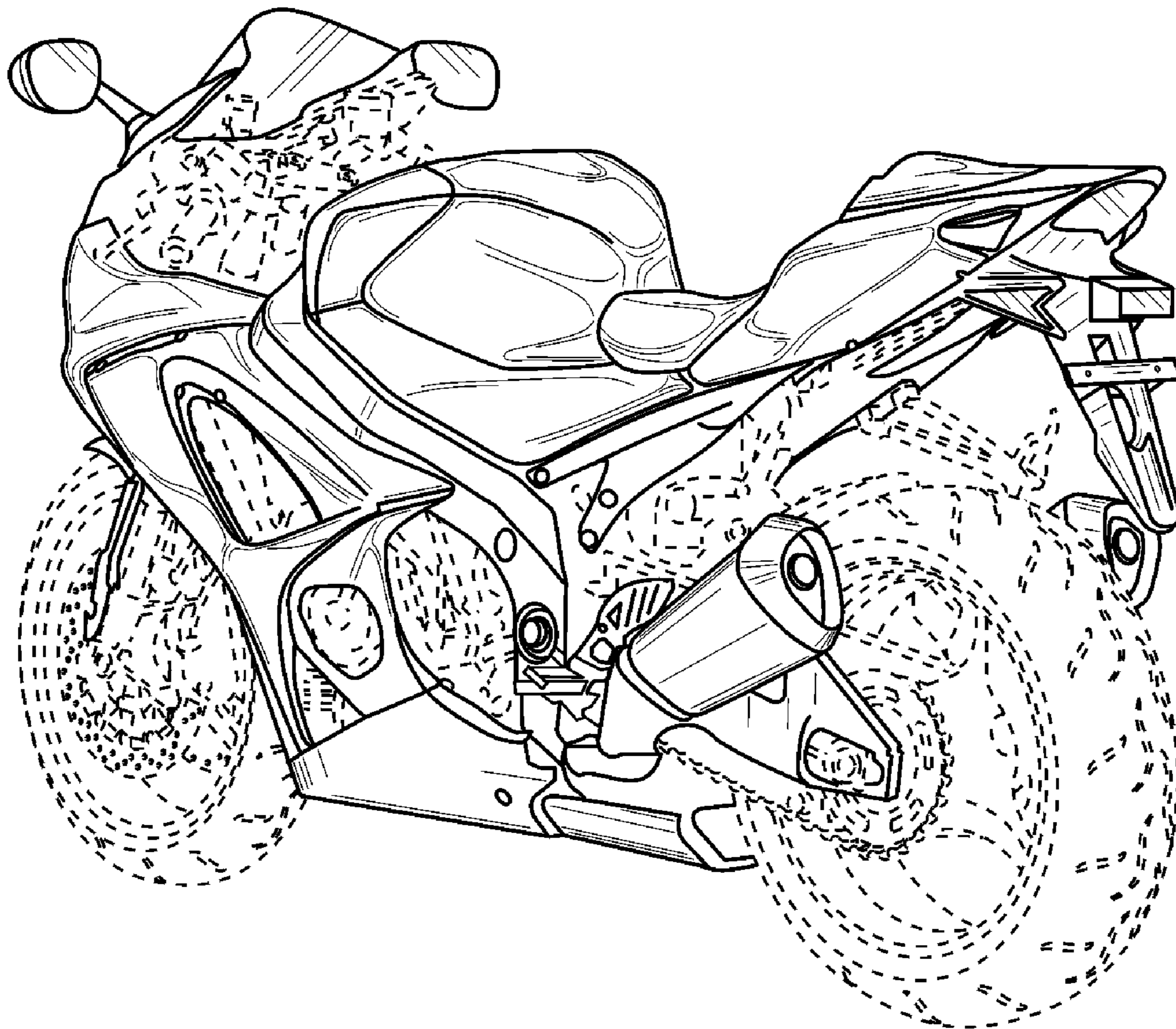

FIG. 10