

US00D564252S

(12) **United States Design Patent**  
**Stengel**

(10) **Patent No.:** **US D564,252 S**

(45) **Date of Patent:** **\*\* Mar. 18, 2008**

(54) **PODIUM**

D488,634 S \* 4/2004 De Bruyn et al. .... D6/422

(76) Inventor: **Michael John Stengel**, 14368 Cedar Springs Dr., Town and Country, MO (US) 63017

\* cited by examiner

*Primary Examiner*—Janice E. Seeger

(\*\*) Term: **14 Years**

(57) **CLAIM**

(21) Appl. No.: **29/250,393**

The ornamental design for a podium, as shown and described.

(22) Filed: **Nov. 13, 2006**

**DESCRIPTION**

(51) **LOC (8) Cl.** ..... **06-03**

FIG. 1 is a perspective view of a podium, showing my new design;

(52) **U.S. Cl.** ..... **D6/419; D6/481**

FIG. 2 is a front elevational view;

(58) **Field of Classification Search** ..... D6/480–489, D6/495–499, 511, 419, 429–431; 108/150, 108/151, 153.1, 155, 156, 157.1, 161; 312/140.1, 312/233

FIG. 3 is a rear elevational view;

FIG. 4 is top plan view;

See application file for complete search history.

FIG. 5 is a side elevational view;

FIG. 6 is a side elevational view, showing the side opposite that shown in FIG. 5; and,

(56) **References Cited**

**U.S. PATENT DOCUMENTS**

FIG. 7 is a bottom plan view thereof.

The broken lines are for environmental purposes only and form no part of the claimed design.

- 2,165,930 A \* 7/1939 Levine et al. .... 312/140.1
- D139,893 S \* 1/1945 Roberts et al. .... D6/481
- D339,933 S \* 10/1993 Fafoutis ..... D6/419
- D375,216 S \* 11/1996 Intardonato ..... D6/481
- D387,584 S \* 12/1997 Gemme ..... D6/486

**1 Claim, 5 Drawing Sheets**

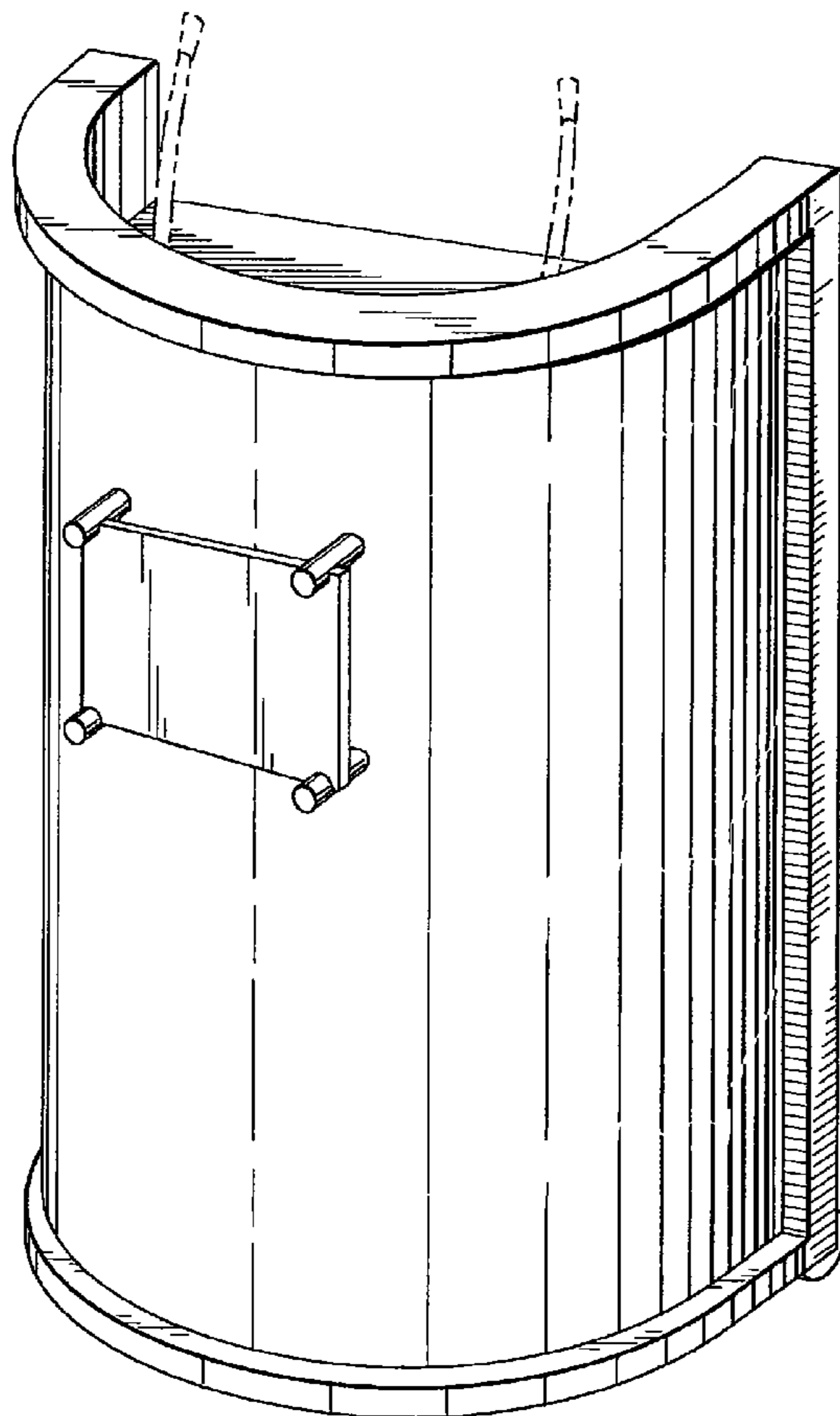

Fig. 1

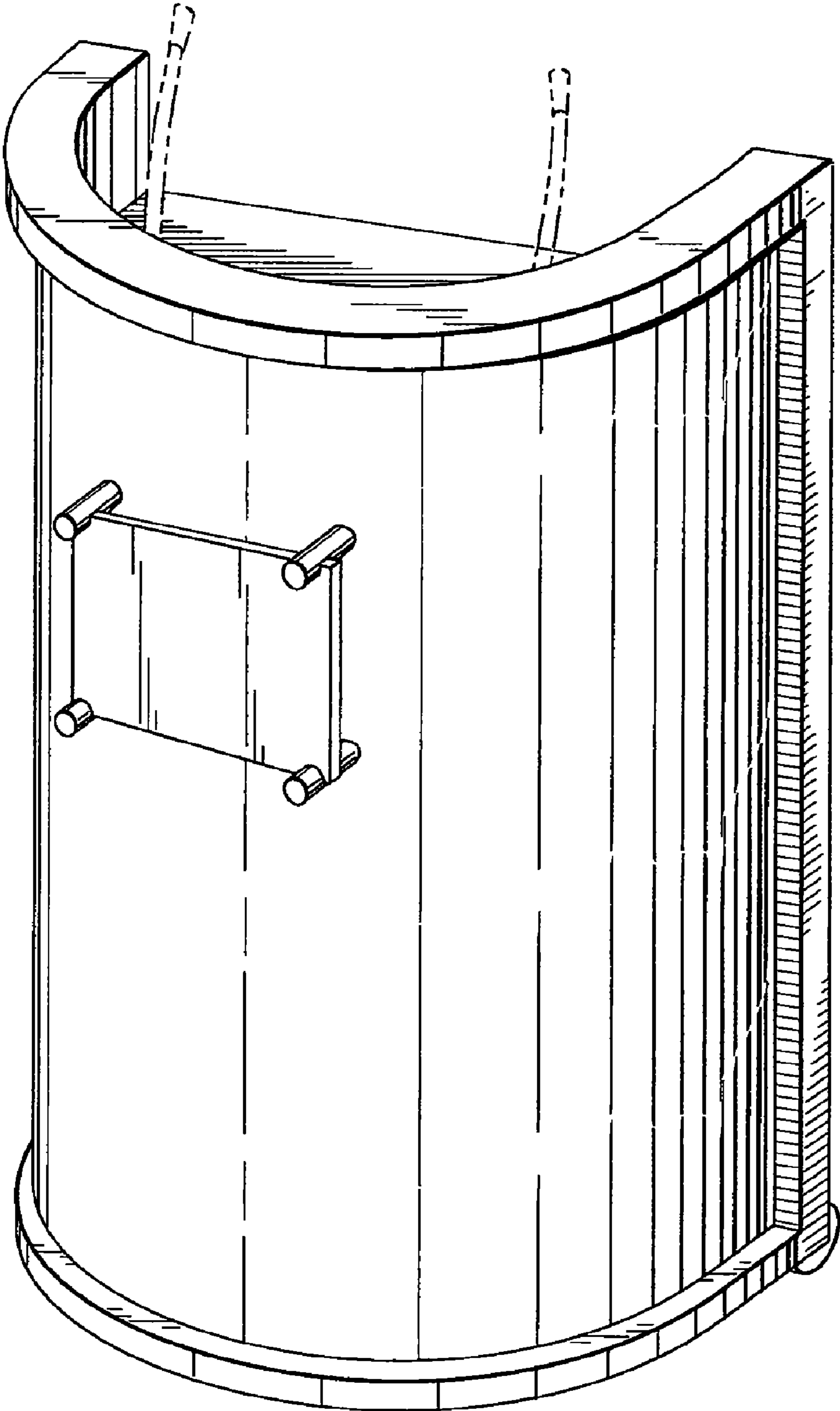

Fig. 2

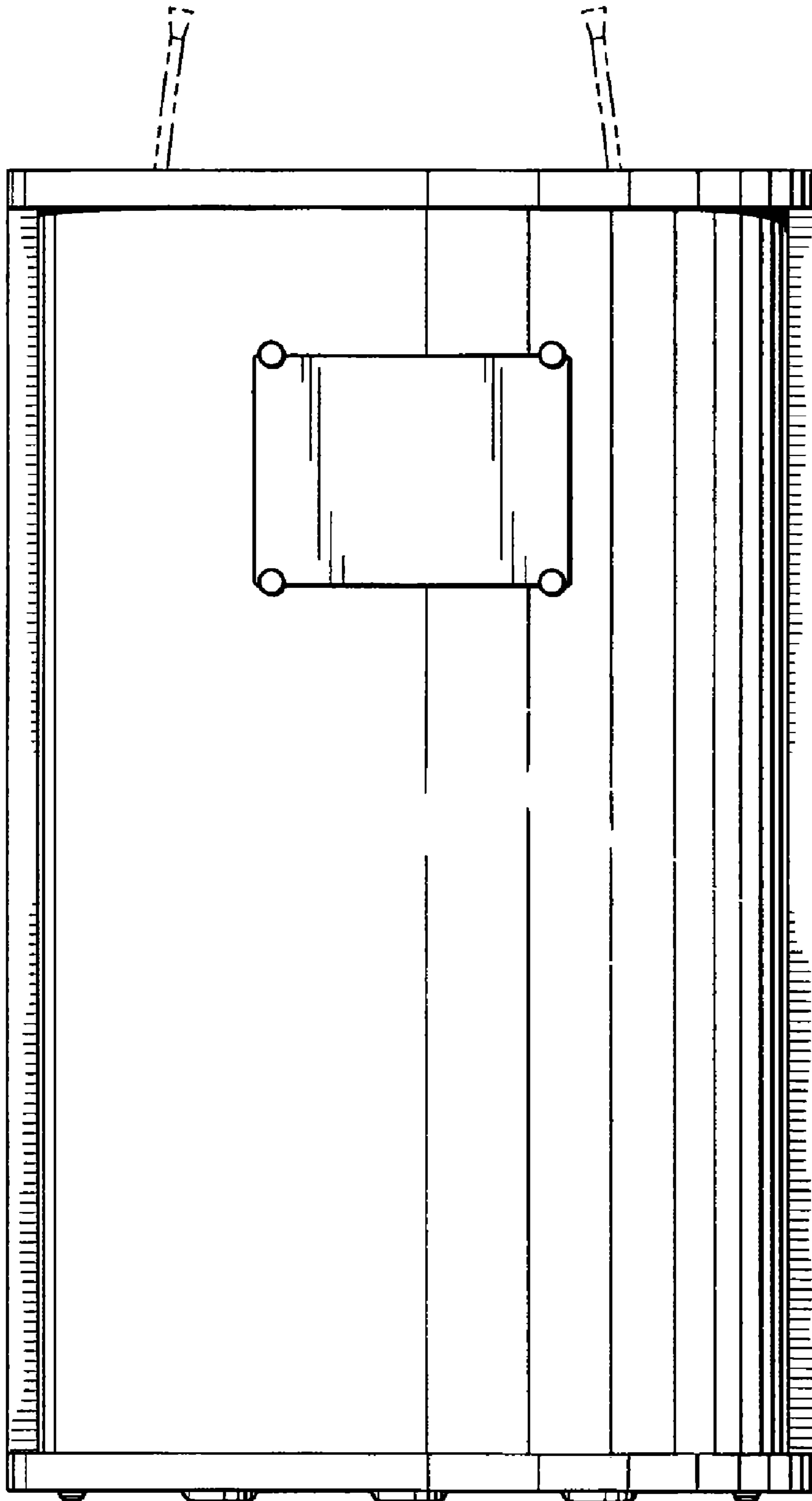

Fig. 3

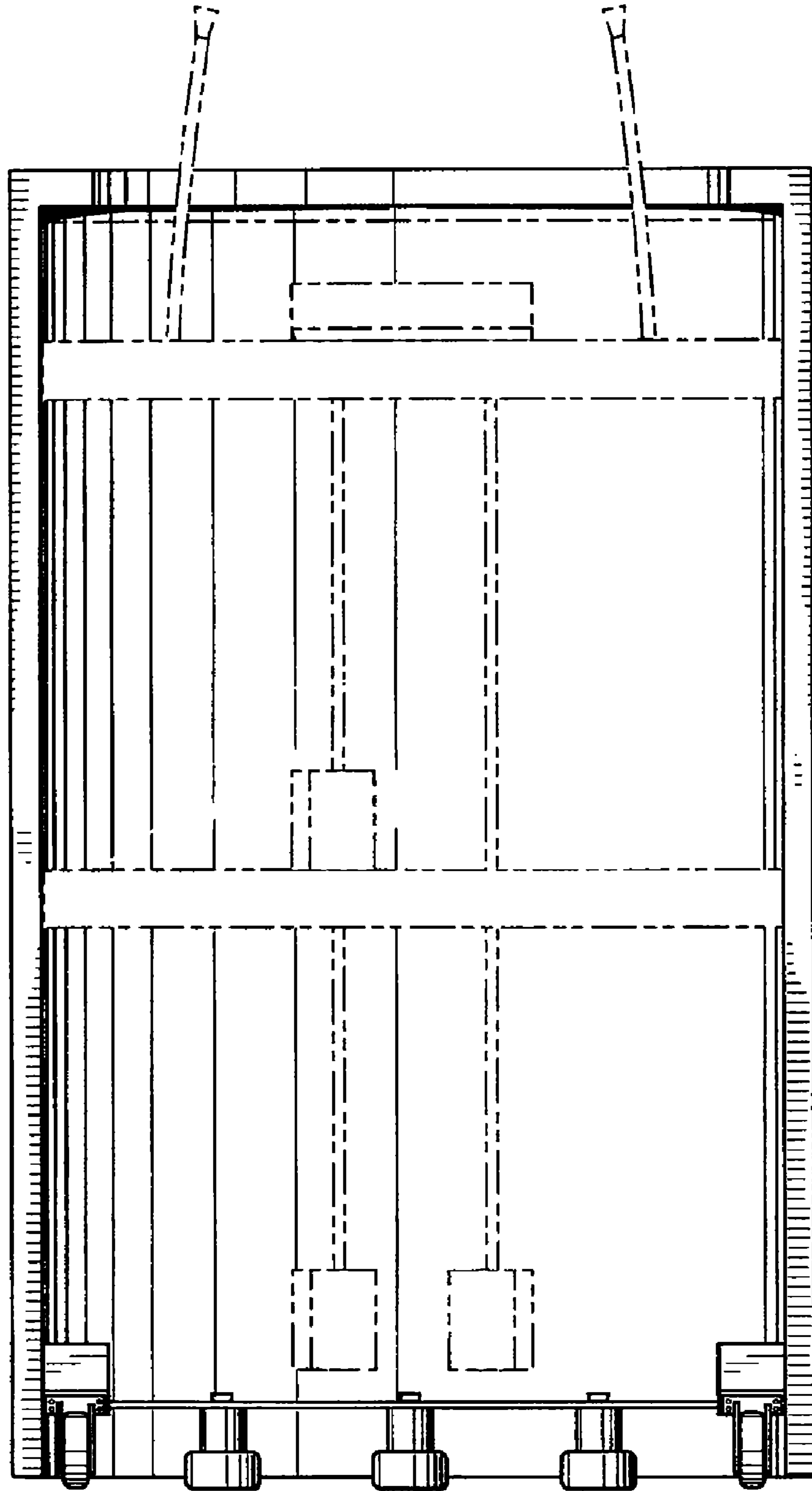

Fig. 4

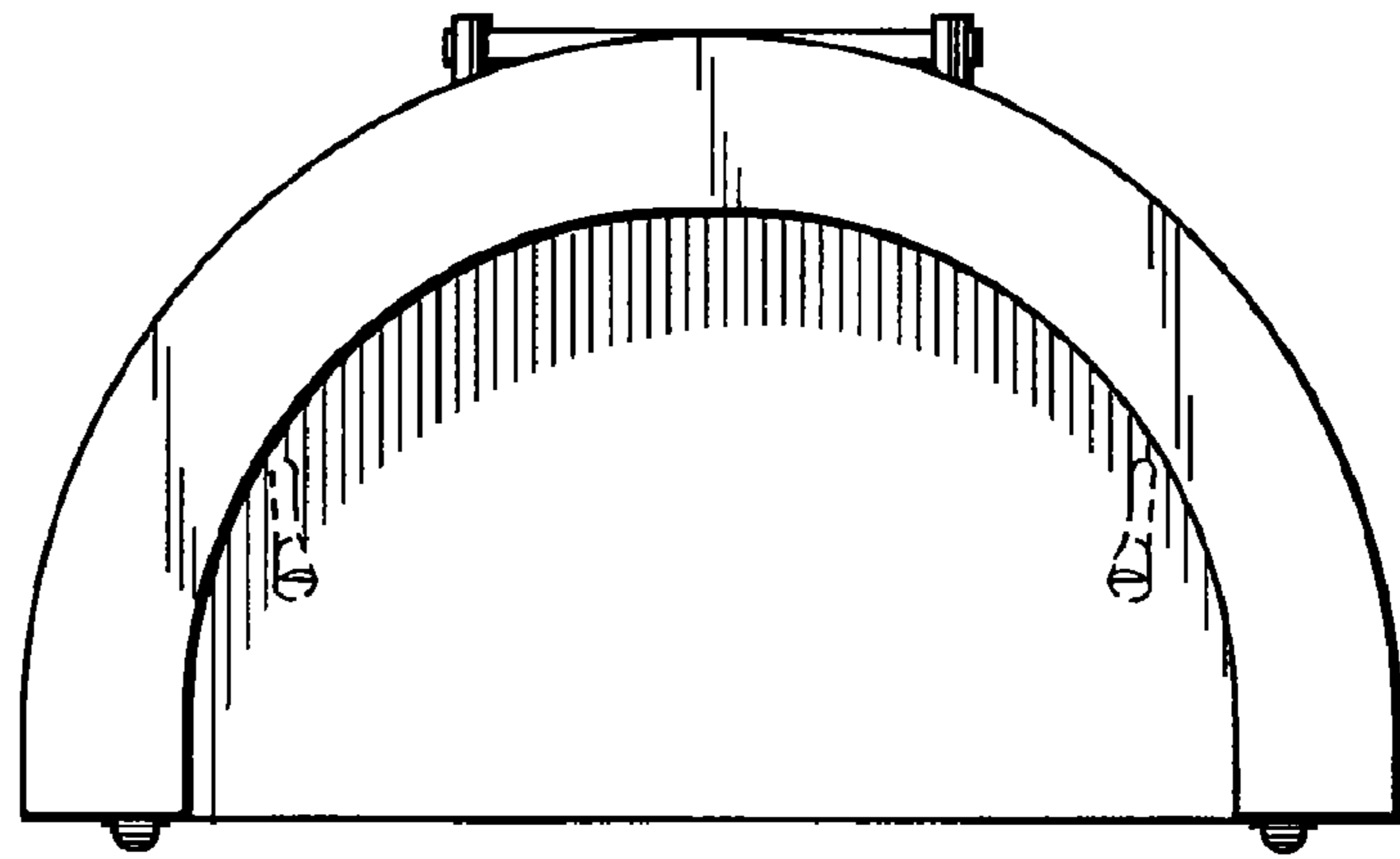
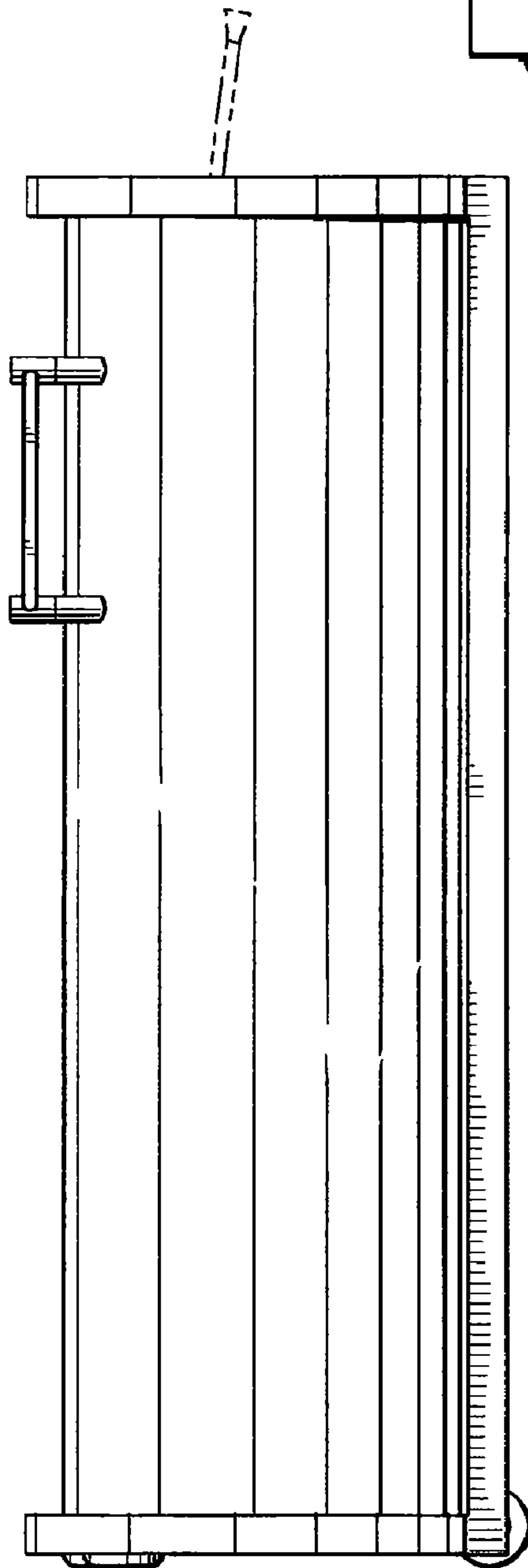

Fig. 5



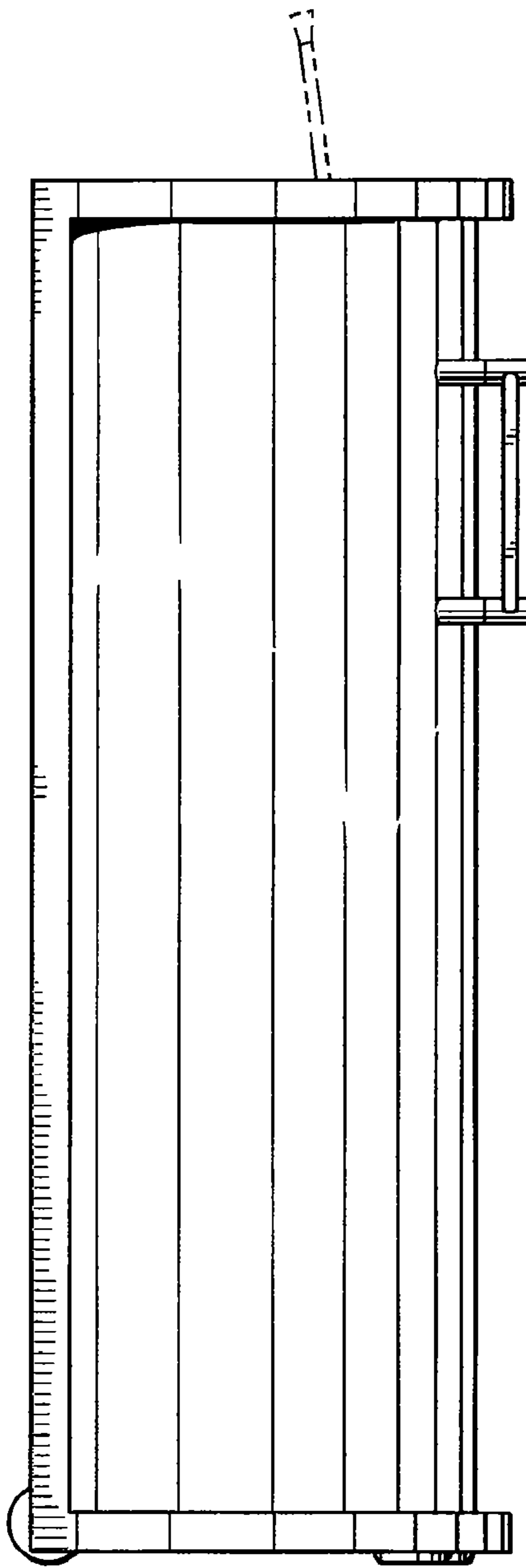

Fig. 6

Fig. 7

