



US00D564250S

(12) **United States Design Patent**  
**Haimoff**

(10) **Patent No.:** **US D564,250 S**  
(45) **Date of Patent:** **\*\* Mar. 18, 2008**

(54) **COLLAPSIBLE TABLE**

FOREIGN PATENT DOCUMENTS

(75) Inventor: **Efraim Haimoff**, Mevasereth Zion (IL)

GB 2389557 A \* 12/2003

(73) Assignee: **Keter Plastic Ltd.**, Herzelyia (IL)

\* cited by examiner

(\*\*) Term: **14 Years**

*Primary Examiner*—Janice E. Seeger  
*Assistant Examiner*—Sydney R. Buffalow

(21) Appl. No.: **29/272,013**

(74) *Attorney, Agent, or Firm*—The Nath Law Group; Jerald L. Meyer; Derek Richmond

(22) Filed: **Jan. 31, 2007**

(57) **CLAIM**

(30) **Foreign Application Priority Data**

The ornamental design for a collapsible table, as shown and described.

Aug. 1, 2006 (IL) ..... 42832

(51) **LOC (8) Cl.** ..... **06-07**

(52) **U.S. Cl.** ..... **D6/397; D6/400**

(58) **Field of Classification Search** ..... D6/400,  
D6/396, 397, 477, 468, 465, 461, 455, 478,  
D6/514, 629, 355, 349, 430, 429; 269/16,  
269/139, 220, 154; 108/29, 27, 64, 59, 42,  
108/56.1, 115, 158.12, 157.16; 312/280,  
312/430; 144/286.1

See application file for complete search history.

(56) **References Cited**

U.S. PATENT DOCUMENTS

- D182,911 S \* 5/1958 Lubberts et al. .... D6/477
- 4,191,113 A \* 3/1980 Hogberg ..... 108/157.16
- 4,310,150 A \* 1/1982 Andrews ..... 269/139
- D266,128 S \* 9/1982 Ferdinand et al. .... D6/400
- D279,736 S \* 7/1985 Zastera et al. .... D6/400
- D345,475 S \* 3/1994 Ferguson ..... D6/477
- D346,709 S \* 5/1994 Nagao ..... D6/400
- D448,200 S \* 9/2001 Sagol ..... D6/400
- 6,769,674 B2 \* 8/2004 Chang ..... 269/139
- 6,827,028 B1 \* 12/2004 Callaway ..... 108/158.12
- 2003/0214088 A1 \* 11/2003 Chang ..... 269/139

**DESCRIPTION**

FIG. 1 is a perspective view of a collapsible table in a closed position;

FIG. 2 is a top plan view thereof;

FIG. 3 is a top plan view thereof;

FIG. 4 is a front view of thereof;

FIG. 5 is a rear view thereof;

FIG. 6 is right side thereof;

FIG. 7 is a left side view thereof;

FIG. 8 is perspective view of a collapsible table in an open position;

FIG. 9 is a top plan view of FIG. 8;

FIG. 10 is a bottom plan view of FIG. 8;

FIG. 11 is a rear view of FIG. 8;

FIG. 12 is a front view of FIG. 8;

FIG. 13 is a right side view of FIG. 8; and,

FIG. 14 is a left side view of FIG. 8.

**1 Claim, 12 Drawing Sheets**

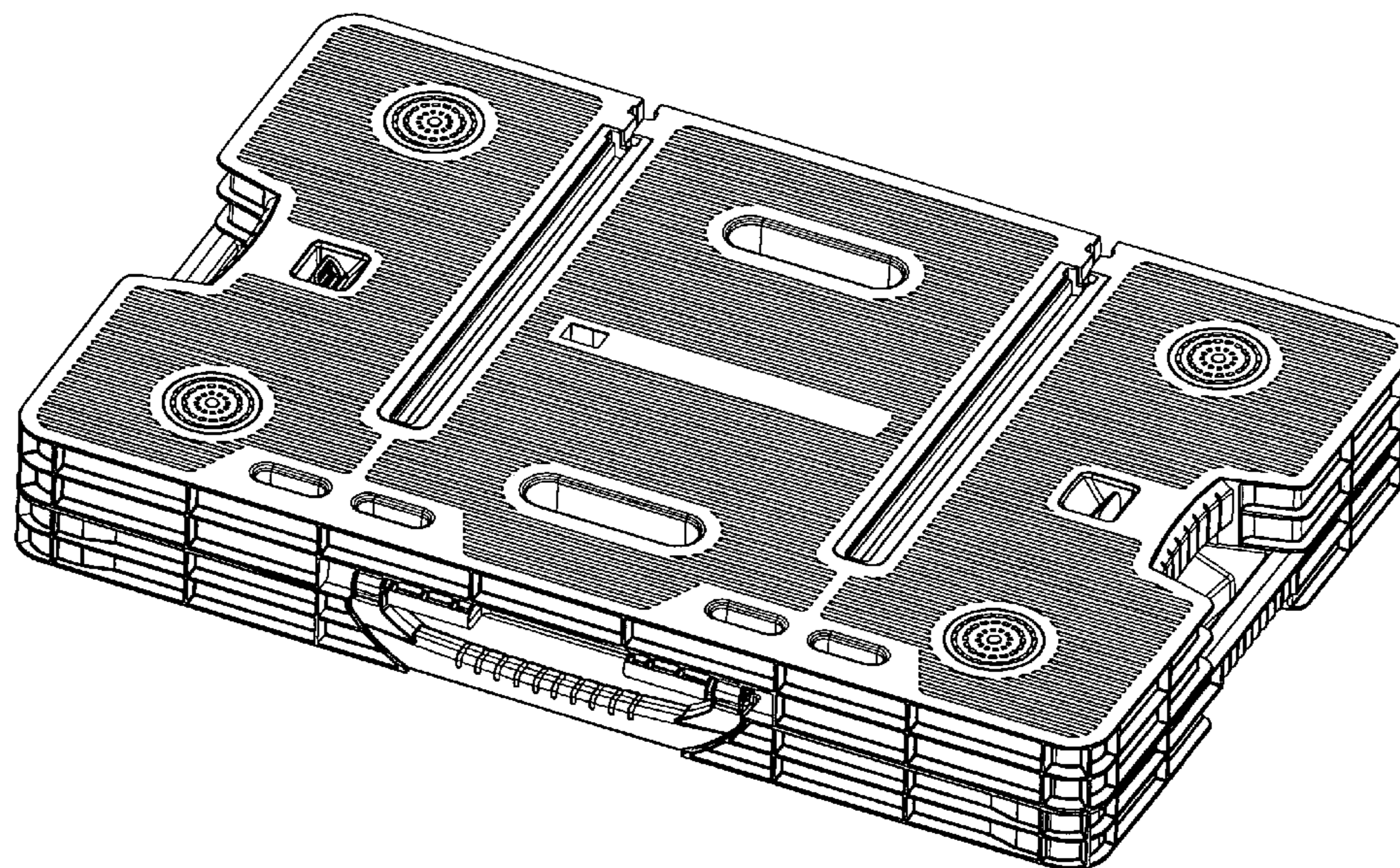

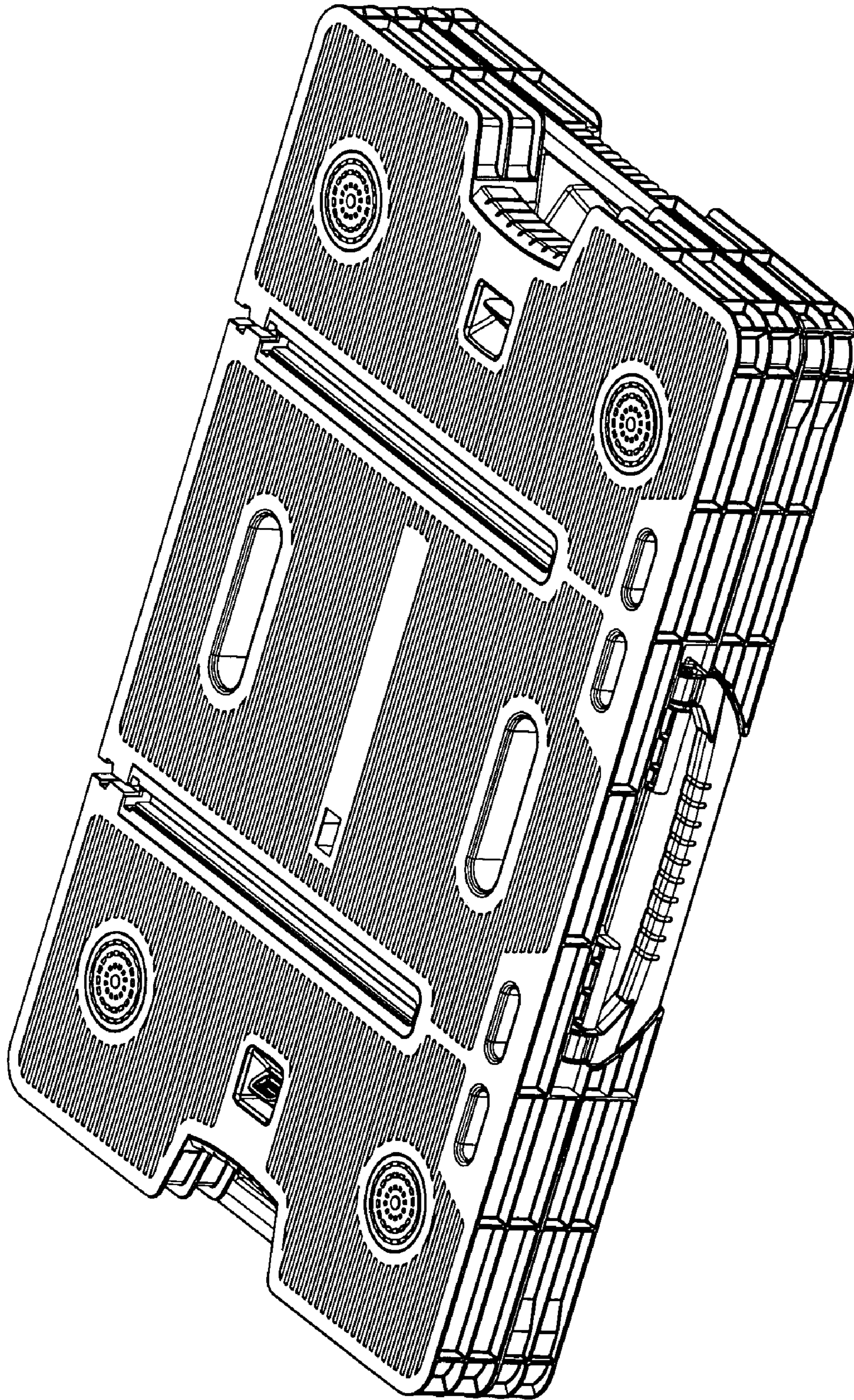

FIG.1

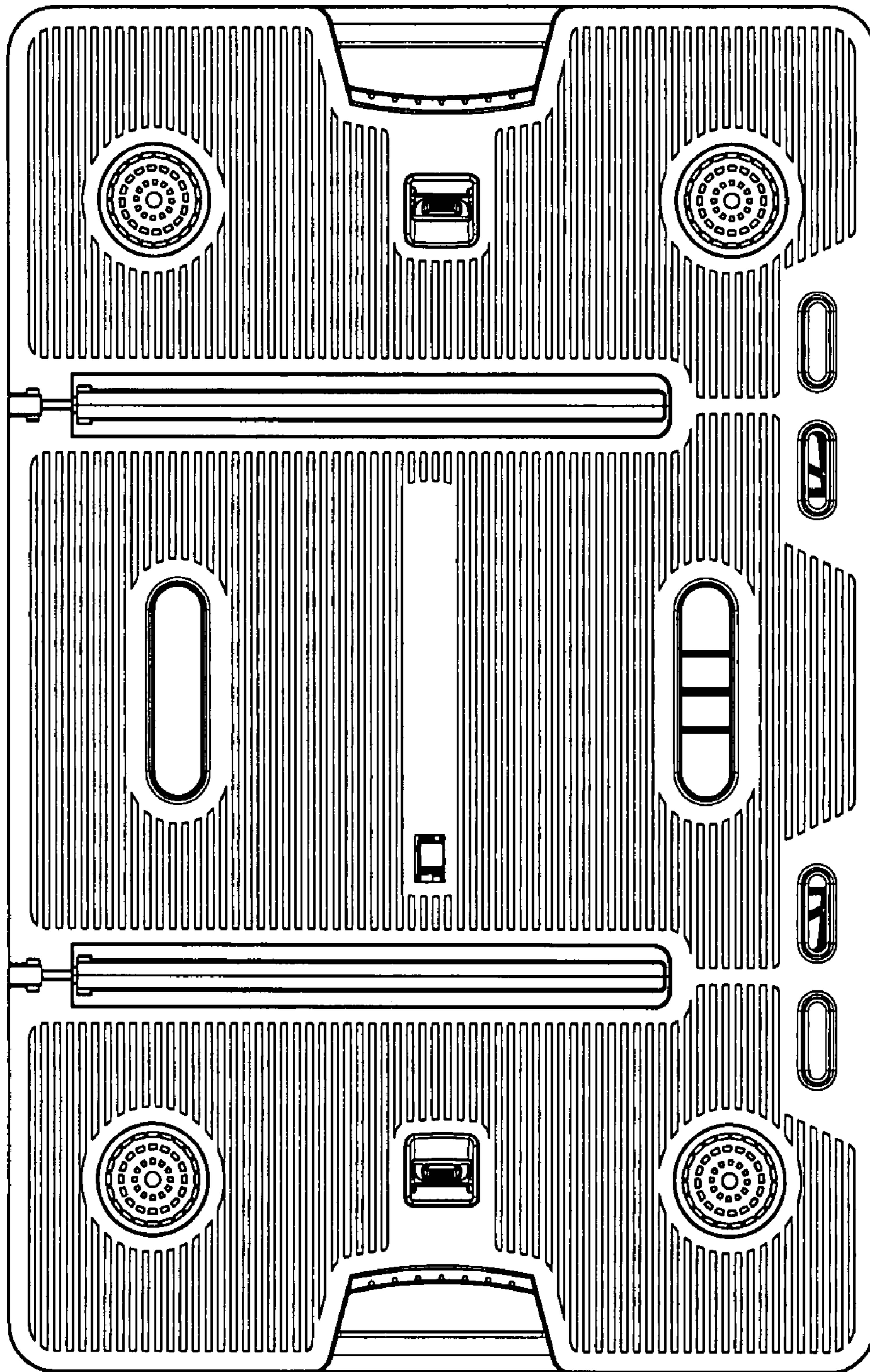

FIG. 2

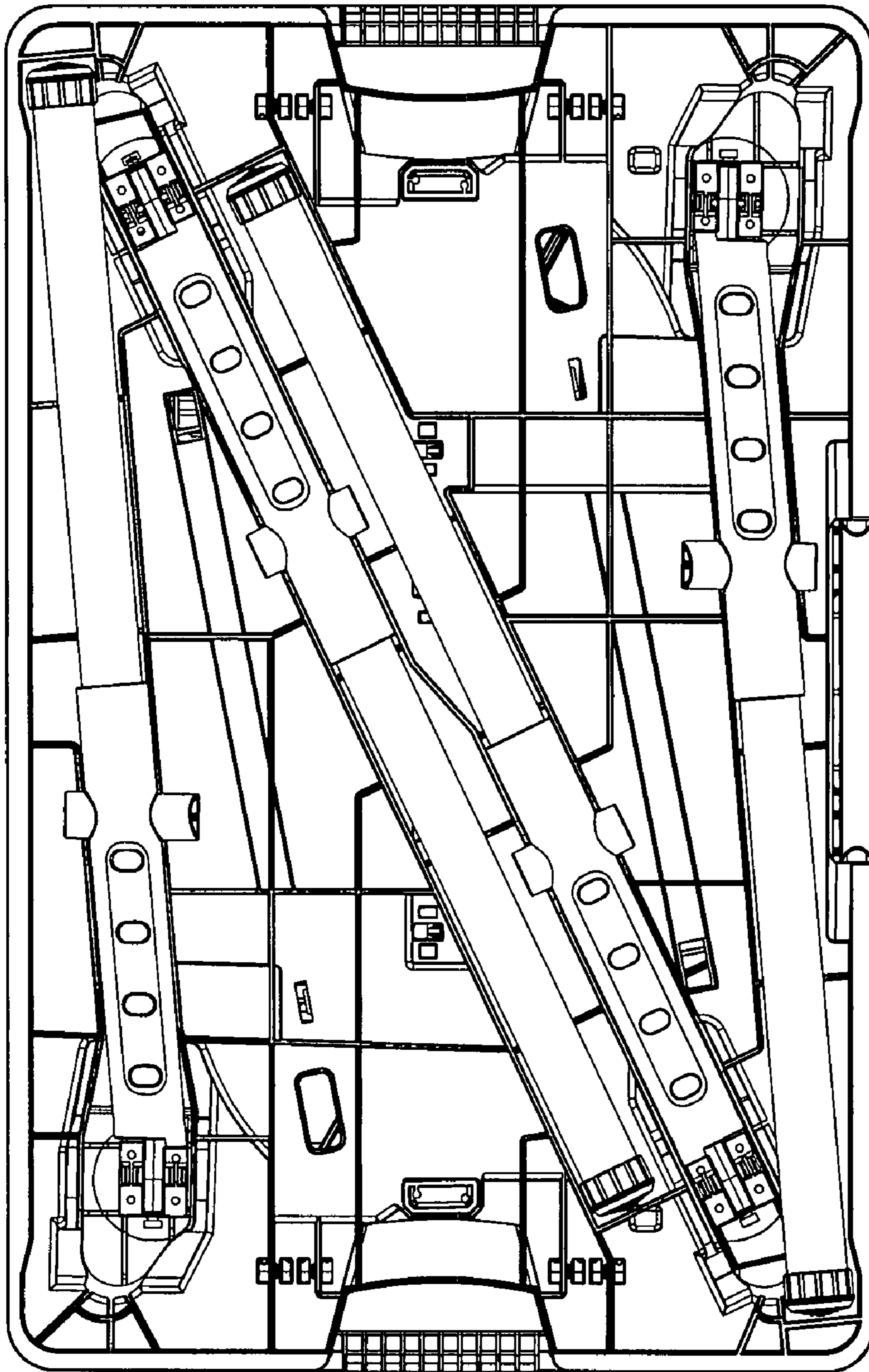

FIG. 3

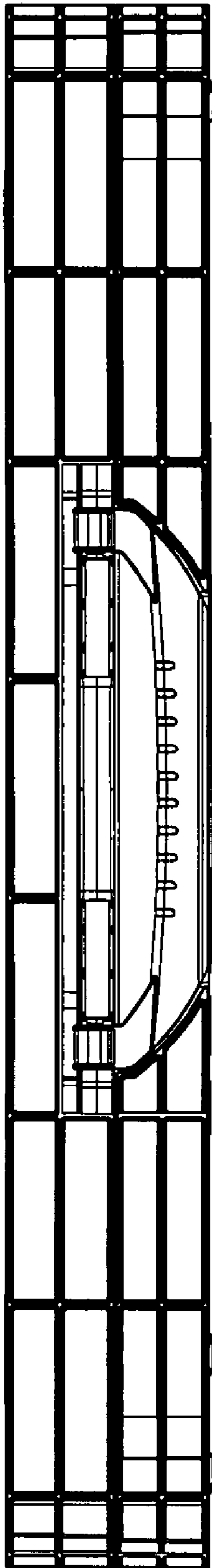

FIG. 4

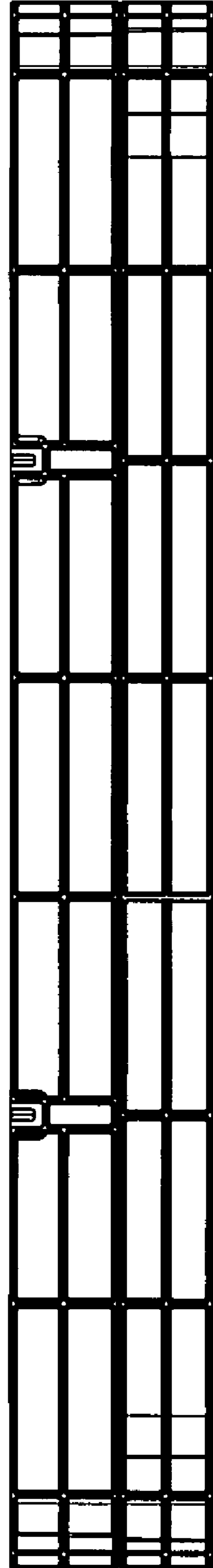

FIG. 5

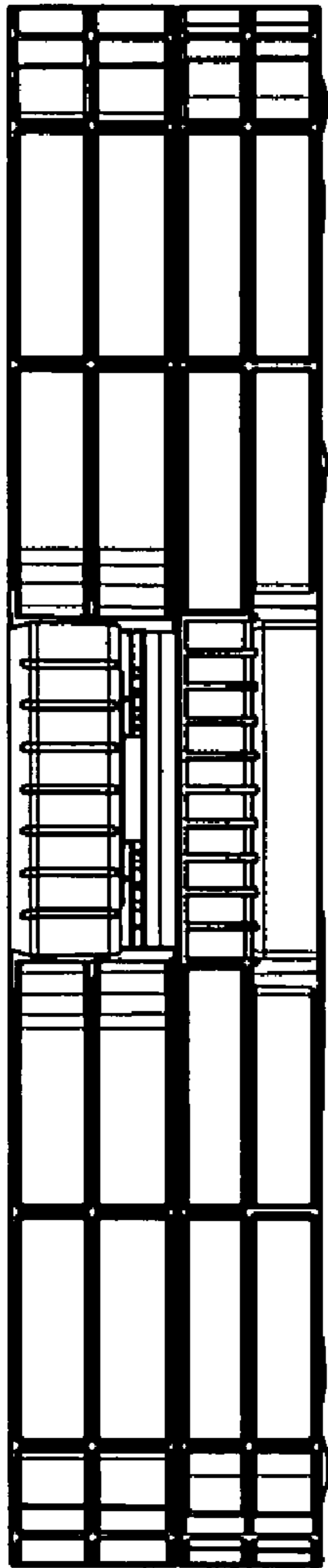

FIG. 6

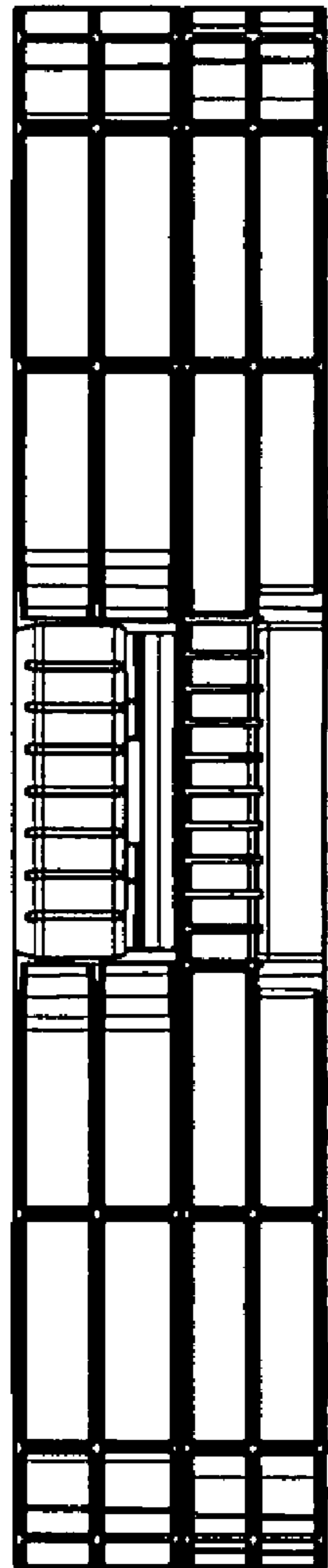

FIG. 7

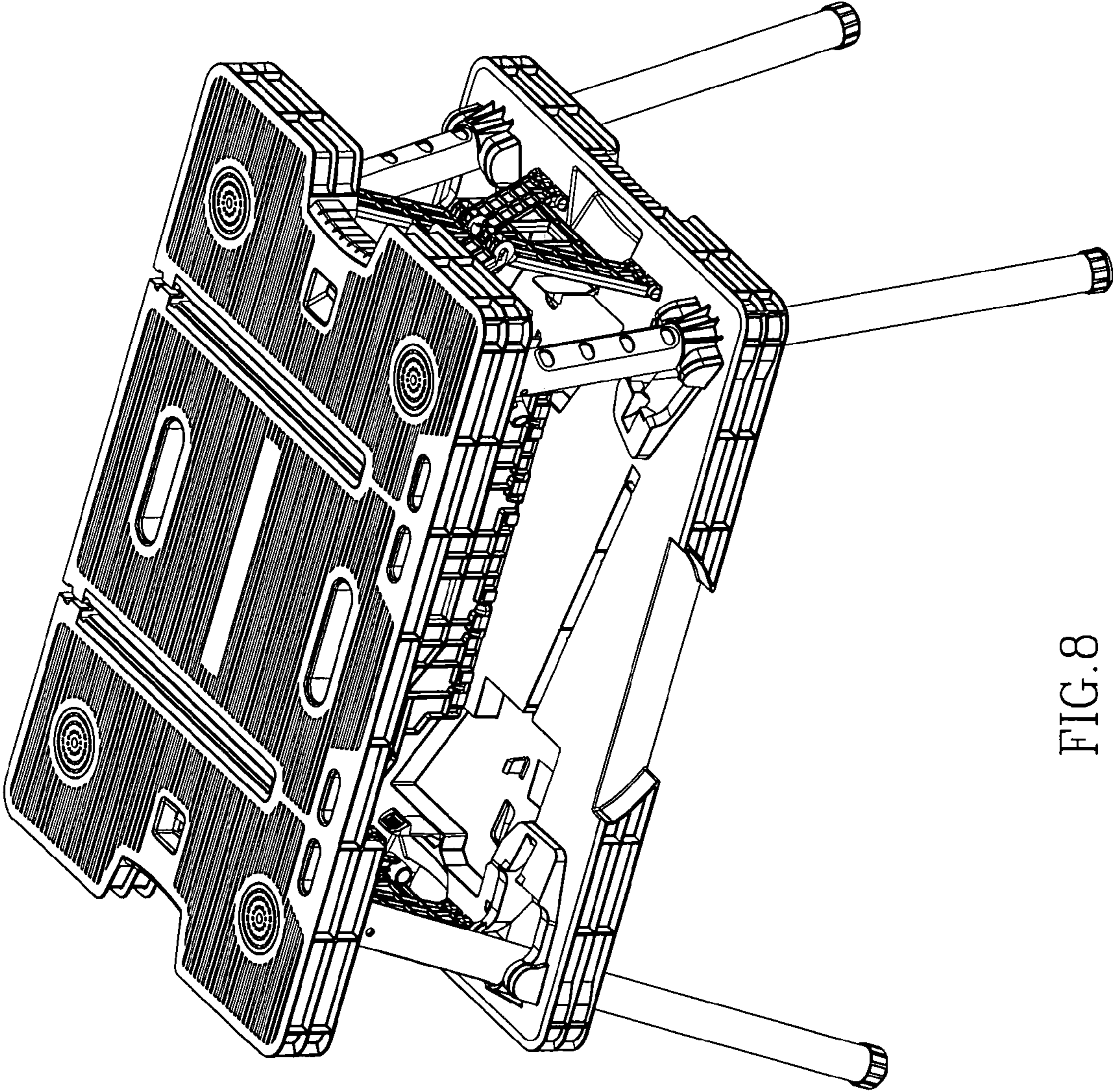

FIG. 8

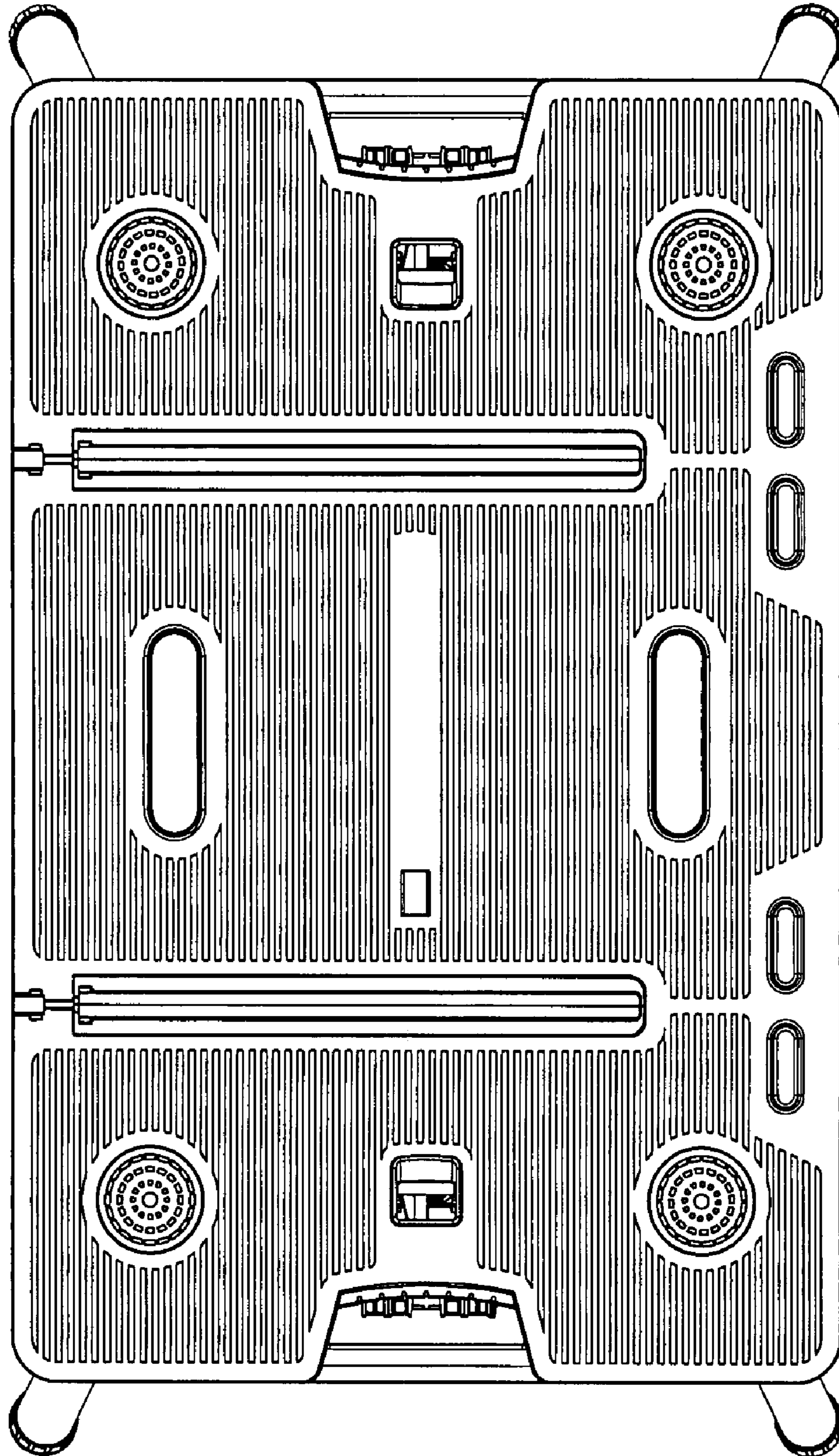

FIG. 9



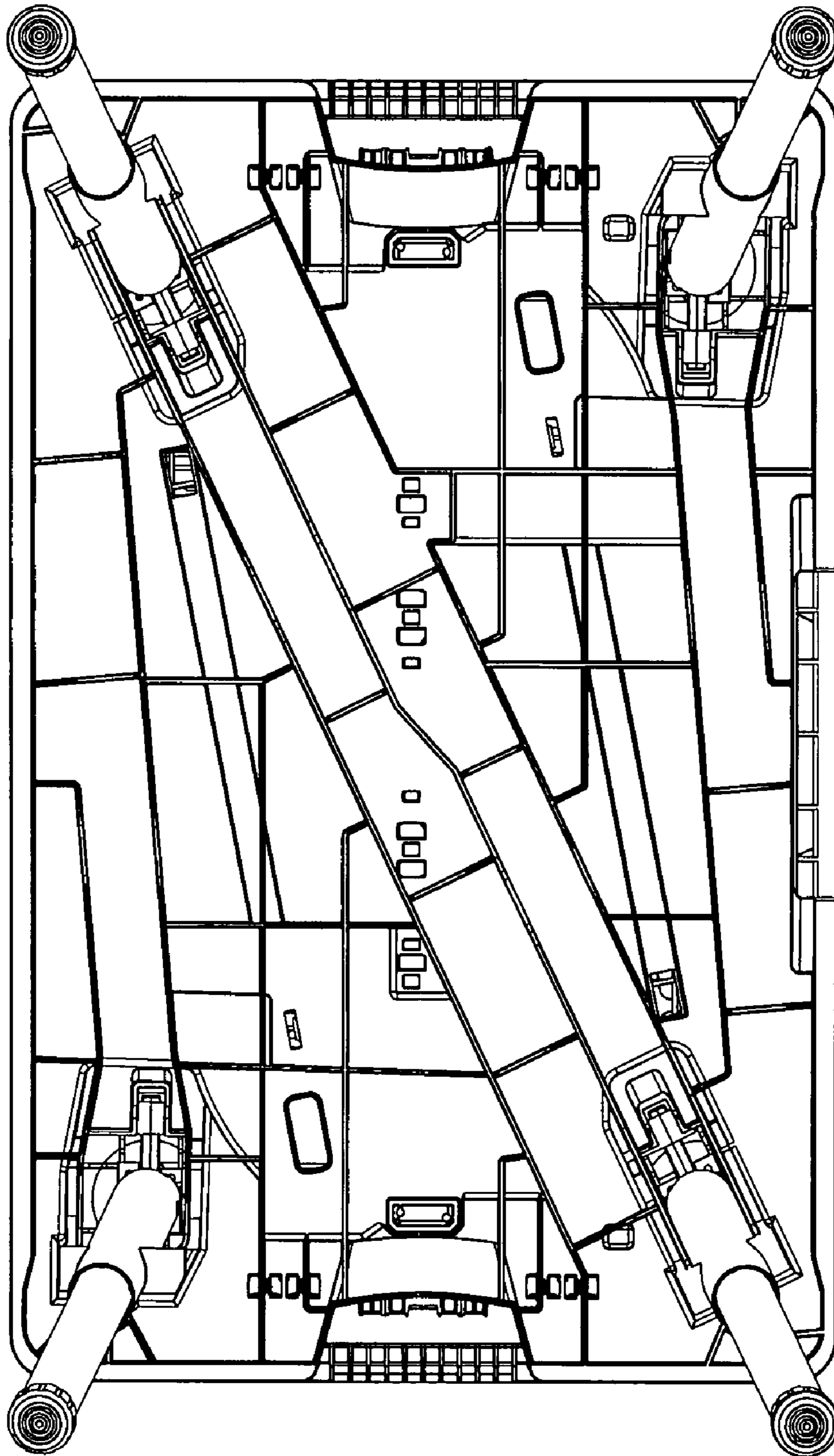

FIG.10

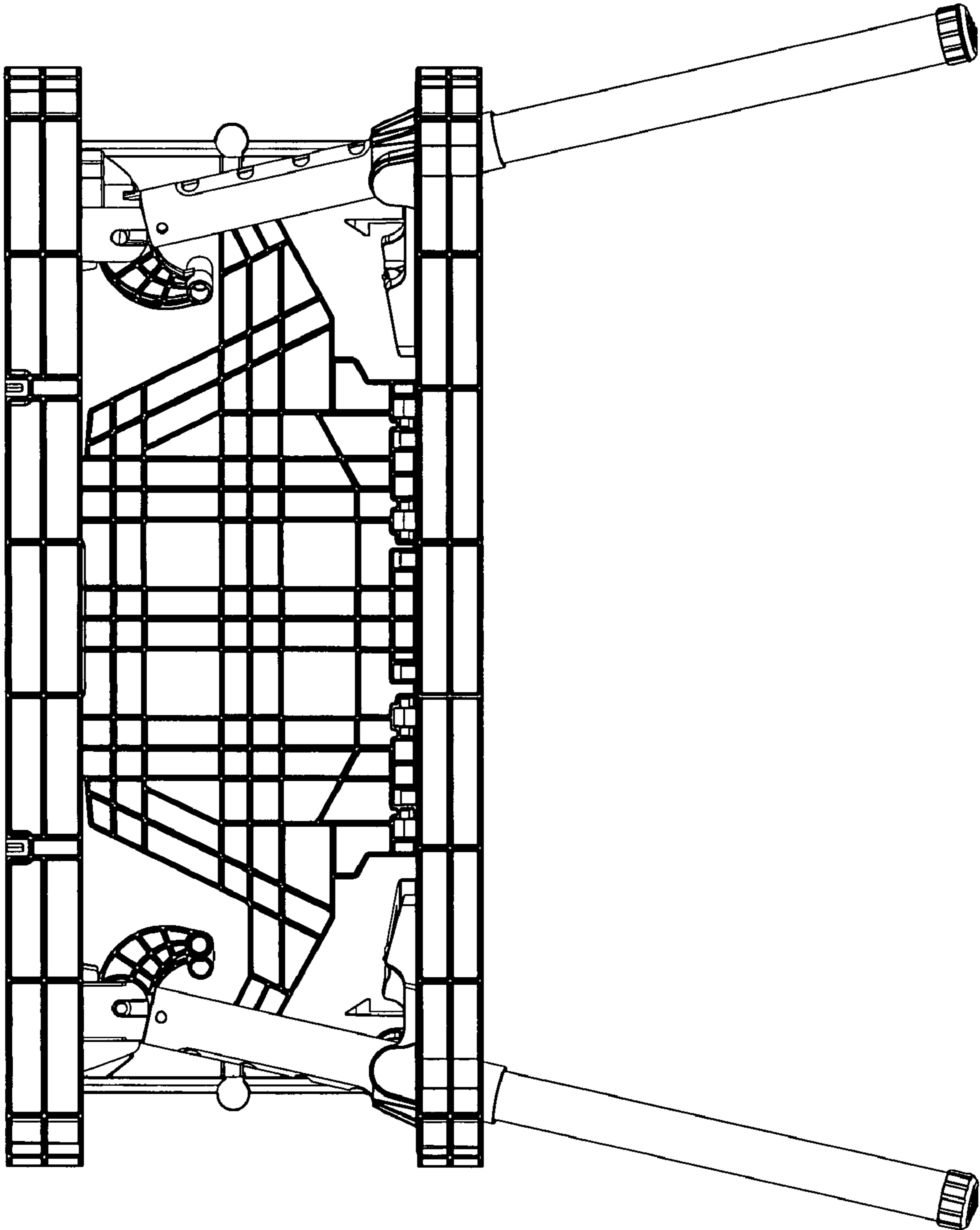

FIG.11

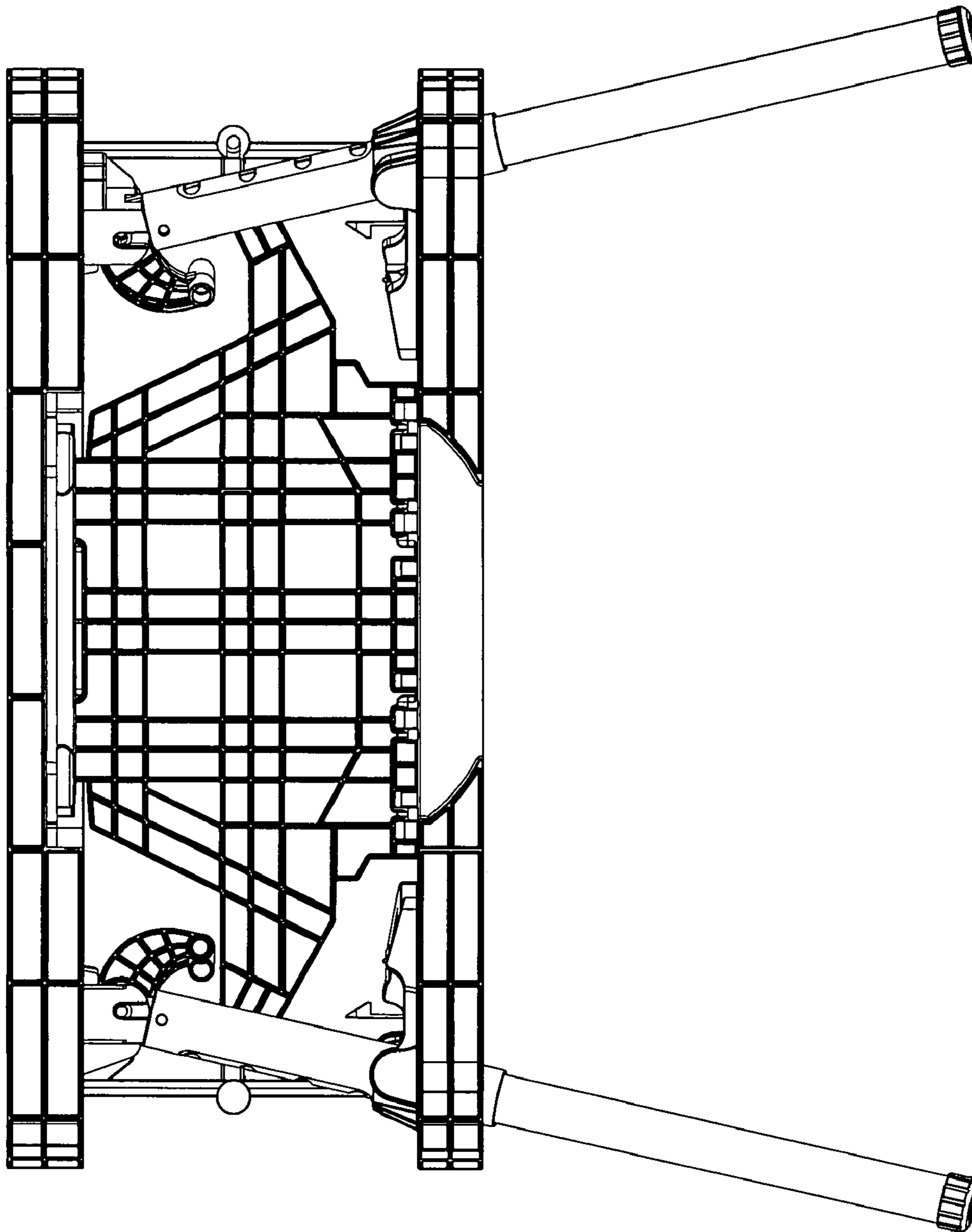

FIG.12

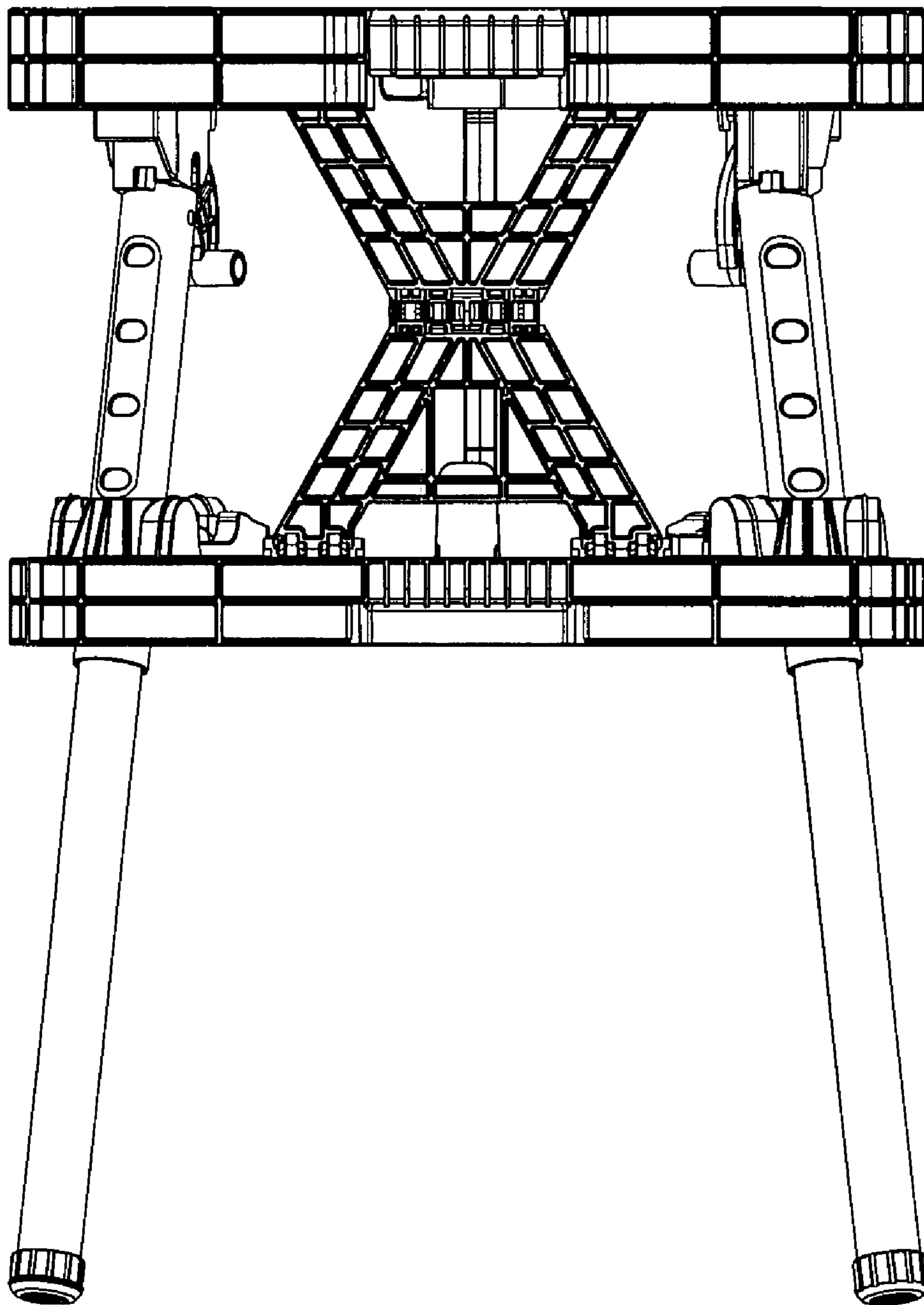

FIG.13

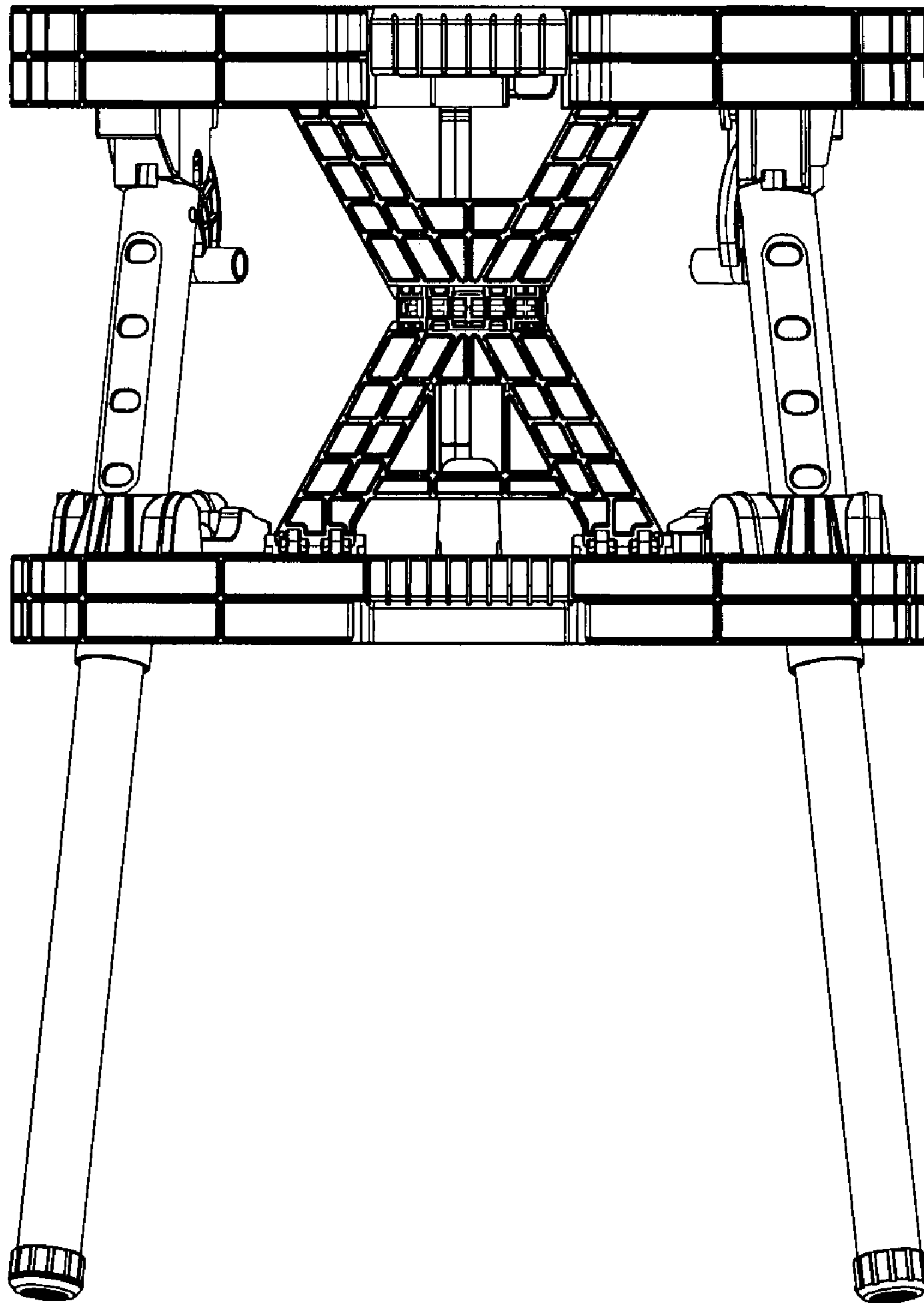

FIG.14