



US00D564130S

(12) **United States Design Patent**
Conway et al.

(10) **Patent No.:** **US D564,130 S**
(45) **Date of Patent:** **** Mar. 11, 2008**

(54) **TRUCK HEADLAMP BEZEL**

(57) **CLAIM**

(75) Inventors: **Scott M. Conway**, Flower Mound, TX (US); **Alan M. Kajihara**, Denton, TX (US); **Derek Sancer**, Denton, TX (US)

The ornamental design for a truck headlamp bezel, as shown and described.

(73) Assignee: **PACCAR Inc**, Bellevue, WA (US)

DESCRIPTION

(**) Term: **14 Years**

FIG. 1 is a front perspective view of a truck headlamp bezel showing a first embodiment of our new design;

(21) Appl. No.: **29/282,418**

FIG. 2 is a front elevational view of the truck headlamp bezel of FIG. 1;

(22) Filed: **Jul. 19, 2007**

FIG. 3 is a rear elevational view of the truck headlamp bezel of FIG. 1;

(51) **LOC (8) Cl.** **26-99**

FIG. 4 is a top plan view of the truck headlamp bezel of FIG. 1;

(52) **U.S. Cl.** **D26/139**

FIG. 5 is a bottom plan view of the truck headlamp bezel of FIG. 1;

(58) **Field of Classification Search** D26/28-36,
D26/139; 362/61, 80-83, 329-340

FIG. 6 is a left side elevational view of the truck headlamp bezel of FIG. 1;

FIG. 7 is a right side elevational view of the truck headlamp bezel of FIG. 1;

See application file for complete search history.

FIG. 8 is a front perspective view of a truck headlamp bezel showing a second embodiment of our new design;

(56) **References Cited**

U.S. PATENT DOCUMENTS

| | | | | |
|--------------|--------|---------------|-------|---------|
| D485,934 S * | 1/2004 | Tsai | | D26/139 |
| D509,923 S * | 9/2005 | Arthur et al. | | D26/139 |
| D544,641 S * | 6/2007 | Elwell et al. | | D26/139 |

FIG. 9 is a front elevational view of the truck headlamp bezel of FIG. 8;

FIG. 10 is a rear elevational view of the truck headlamp bezel of FIG. 8;

FIG. 11 is a top plan view of the truck headlamp bezel of FIG. 8;

FIG. 12 is a bottom plan view of the truck headlamp bezel of FIG. 8;

* cited by examiner

FIG. 13 is a left side elevational view of the truck headlamp bezel of FIG. 8; and,

FIG. 14 is a right side elevational view of the truck headlamp bezel of FIG. 8.

Primary Examiner—Marcus A. Jackson

(74) *Attorney, Agent, or Firm*—Christensen O'Connor Johnson Kindness PLLC

1 Claim, 10 Drawing Sheets

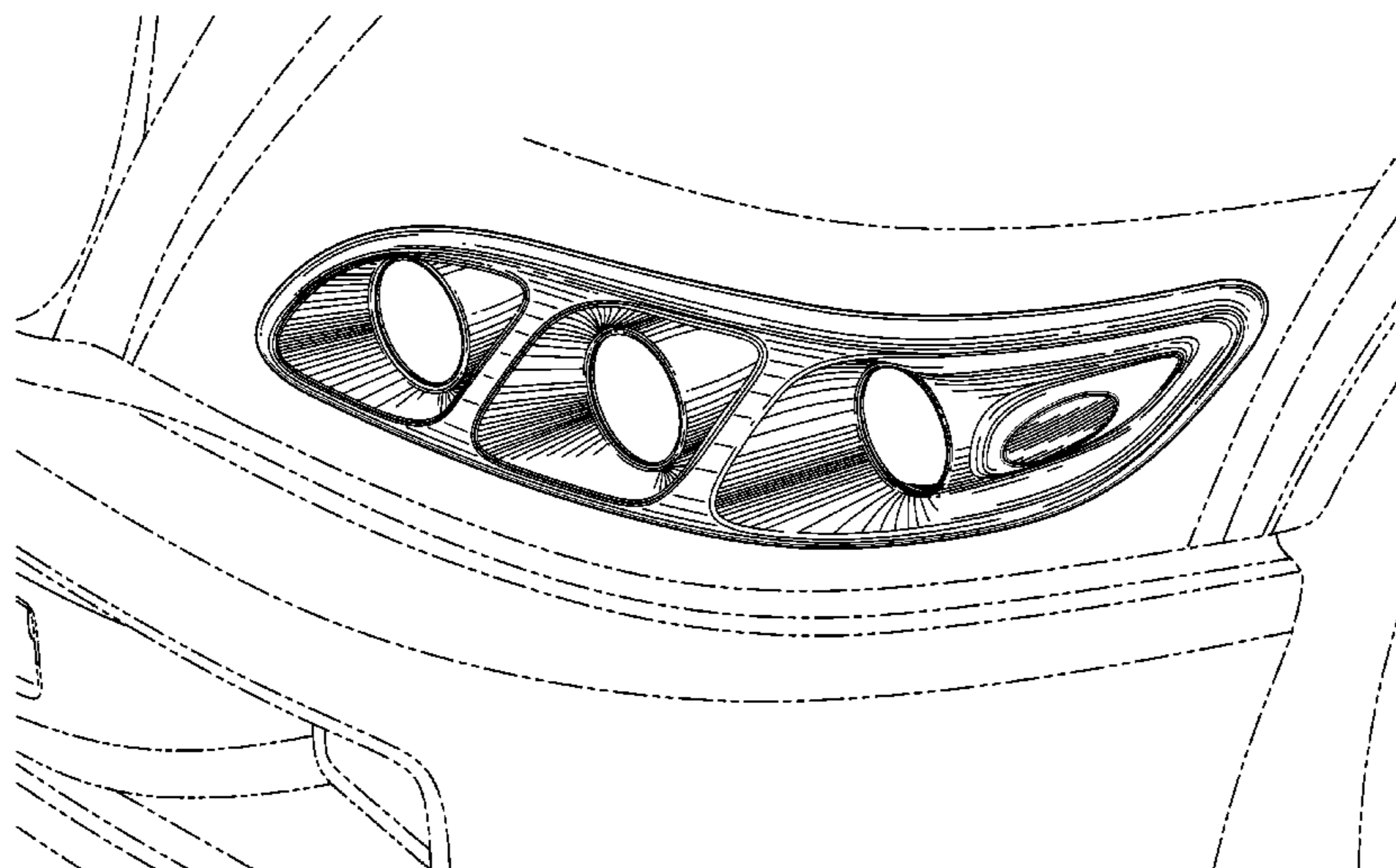

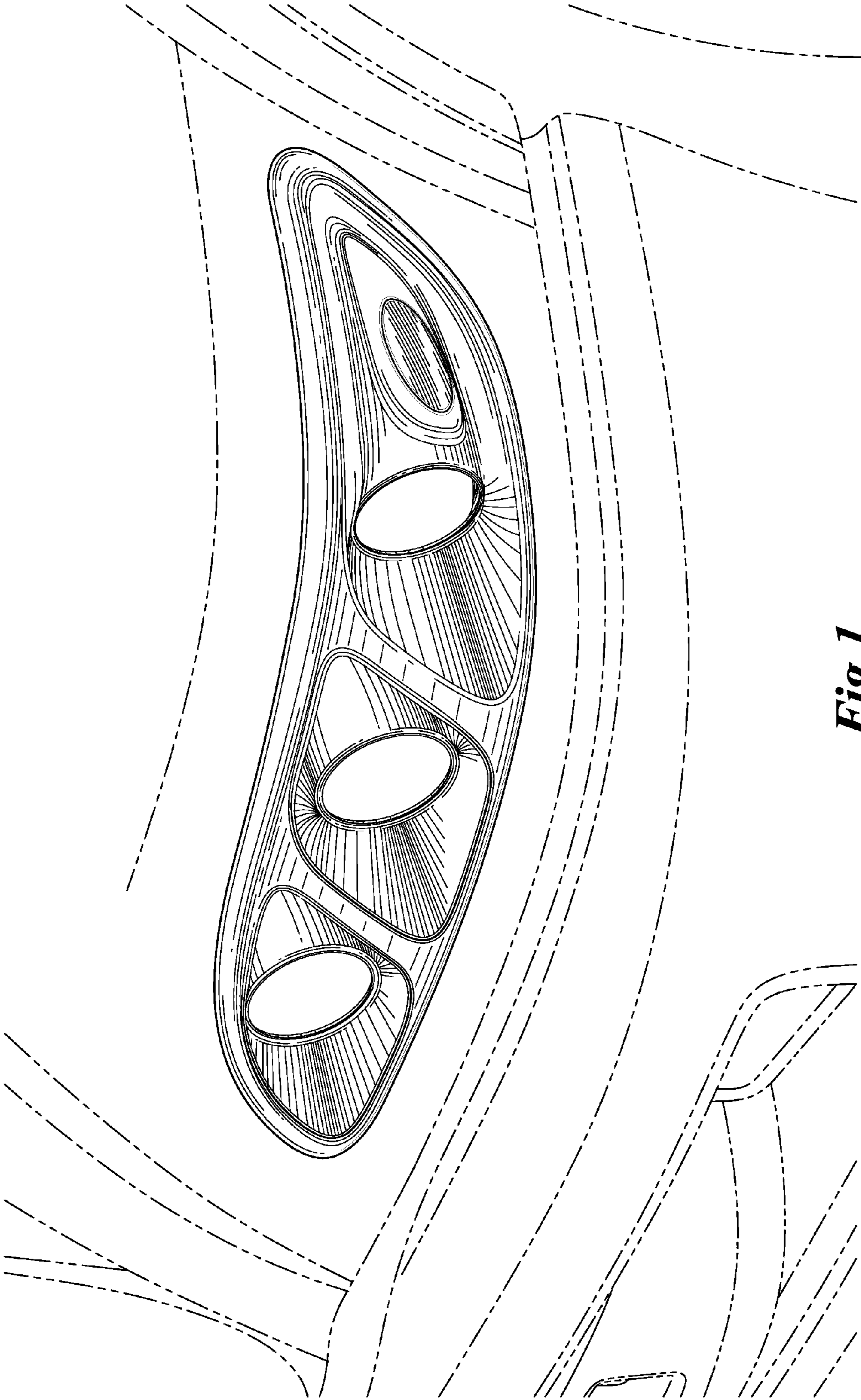

Fig. 1.

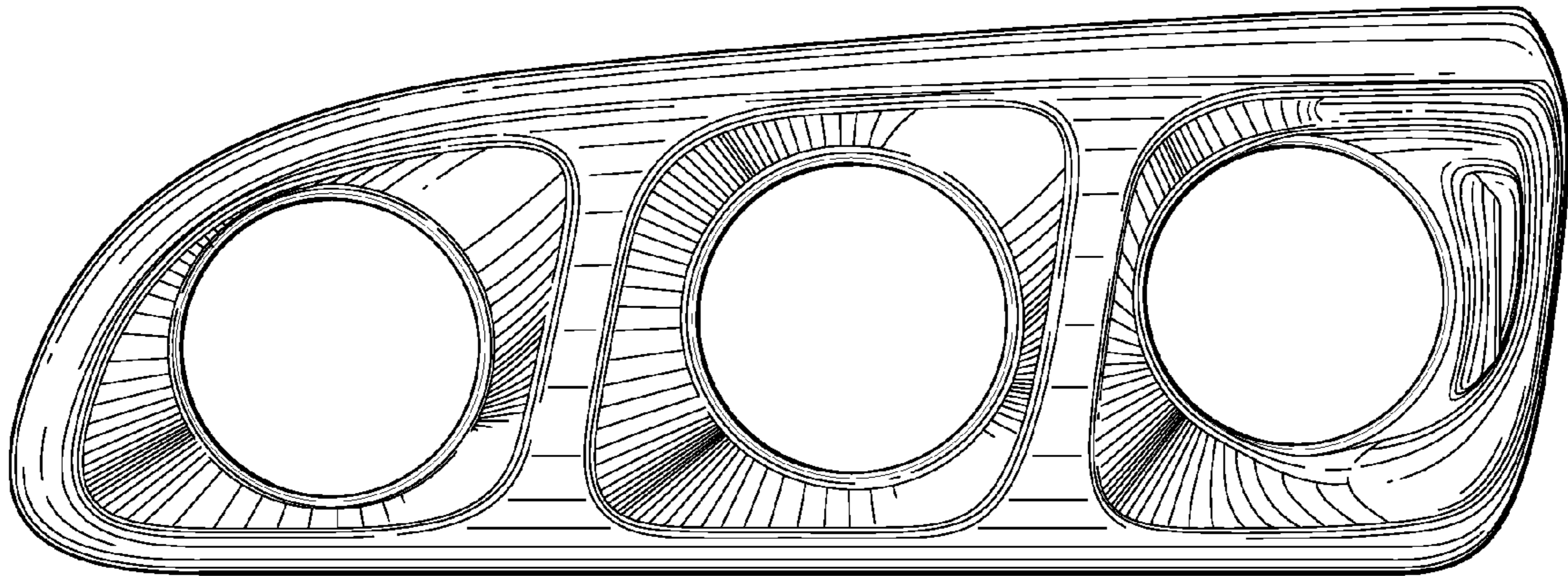

Fig. 2.

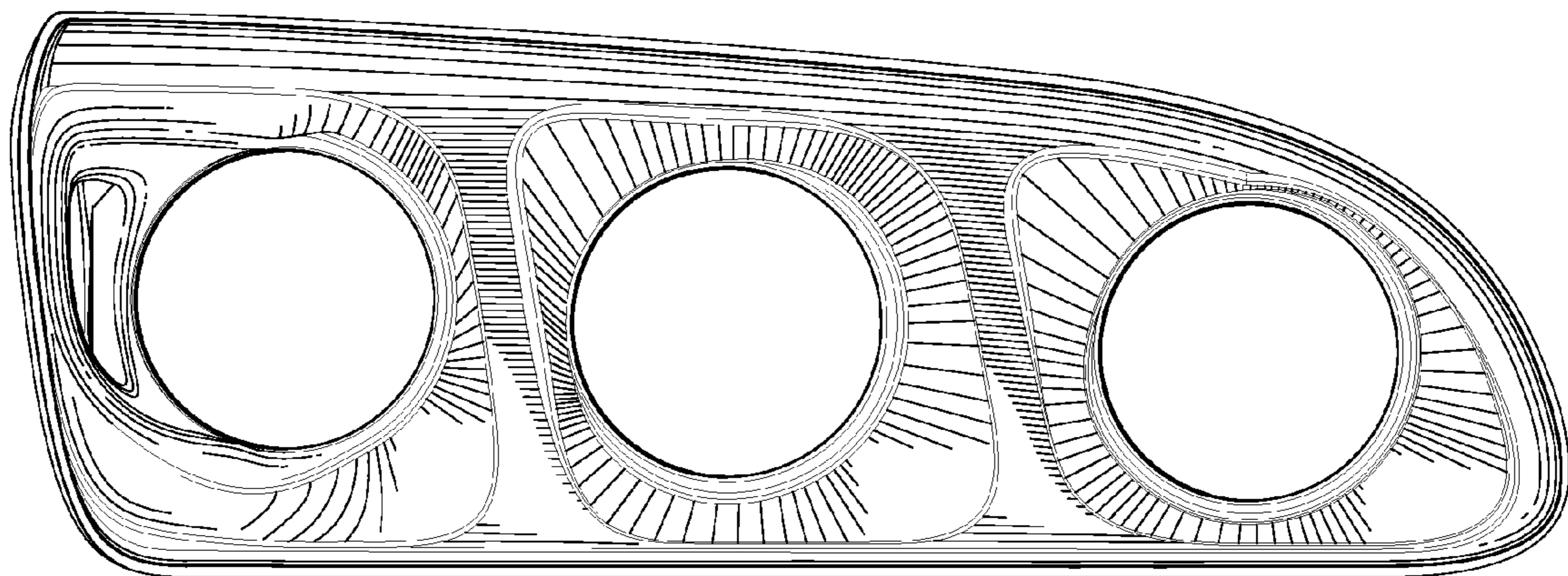

Fig. 3.

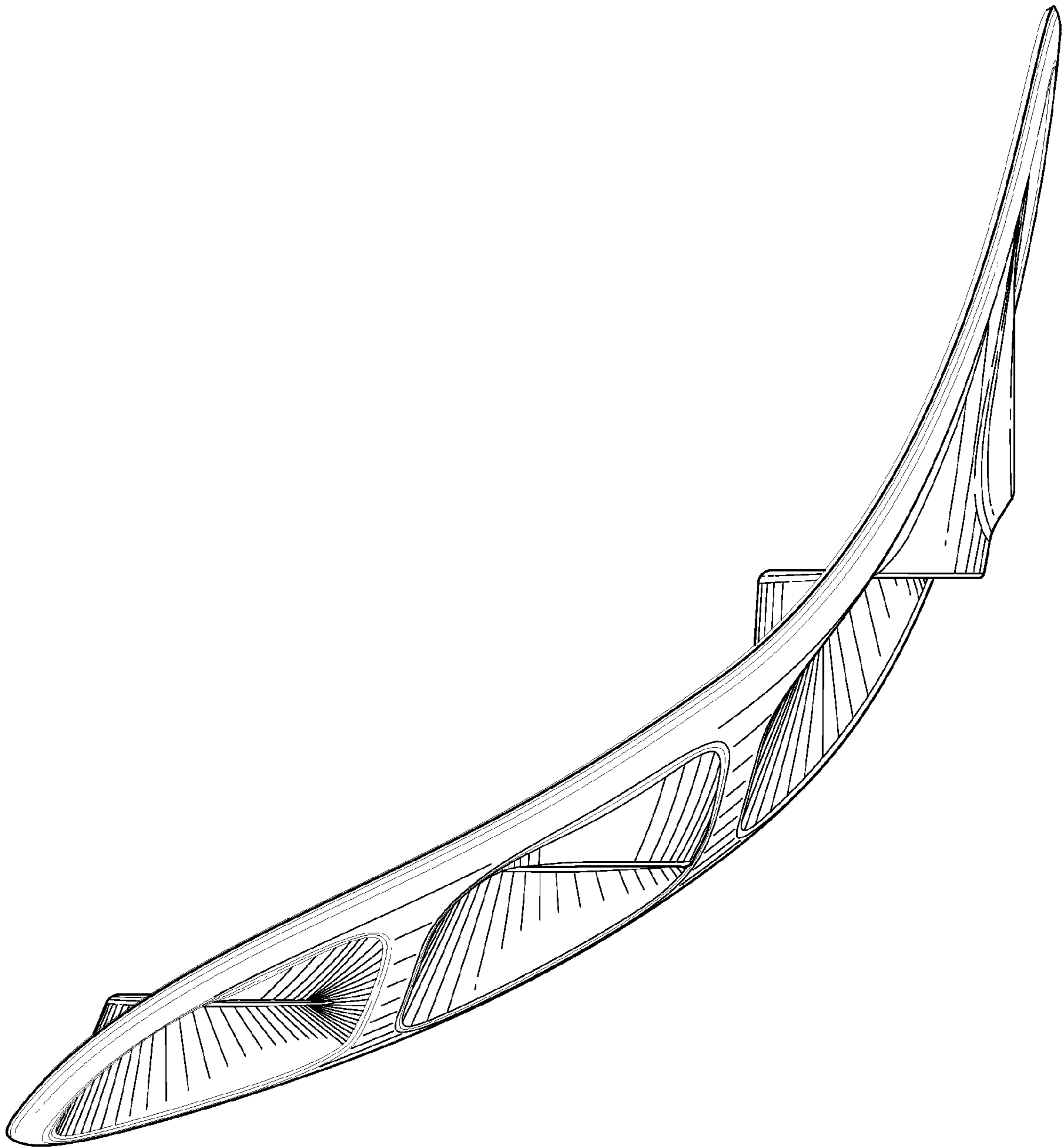

Fig.4.

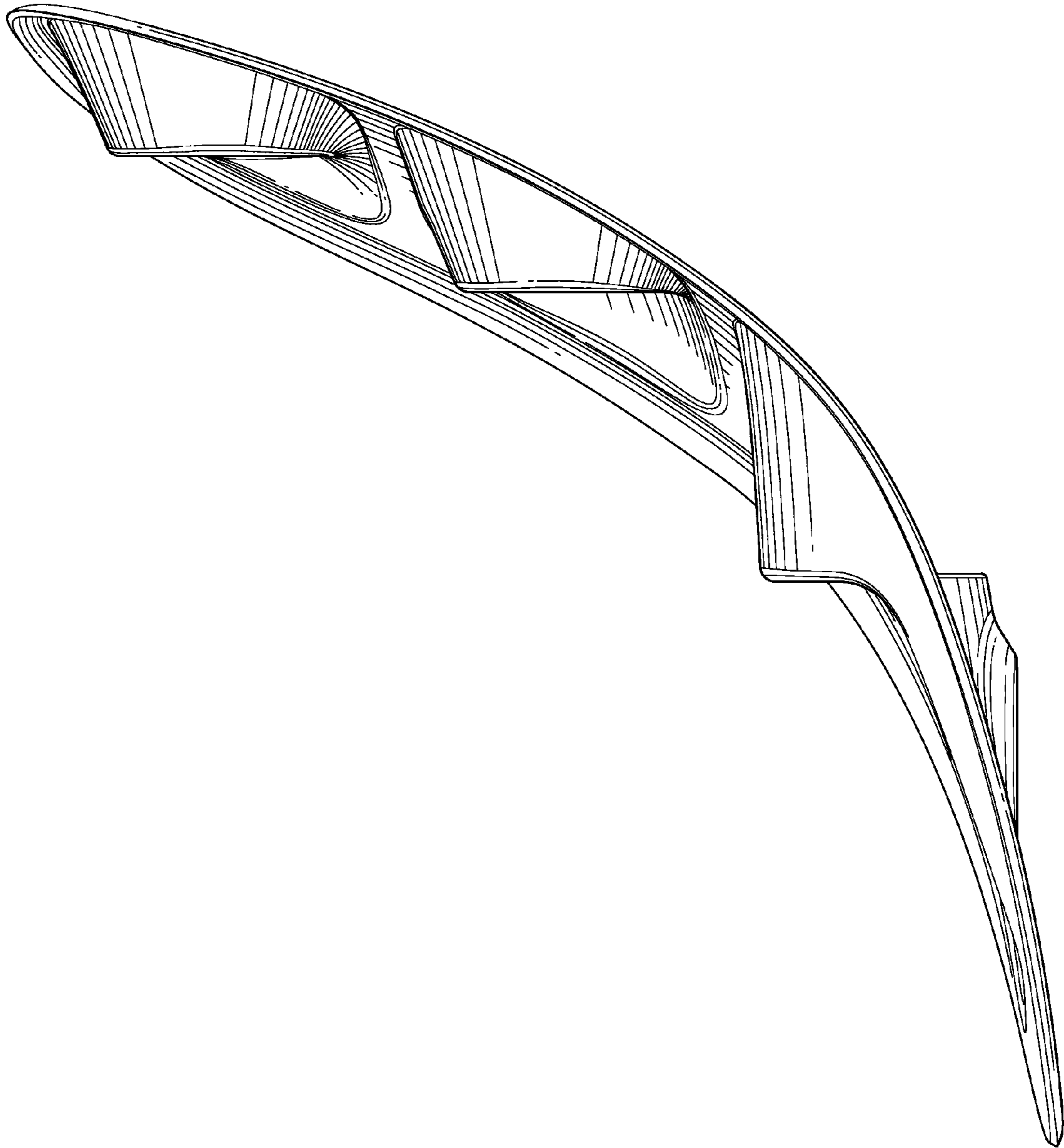

Fig. 5.

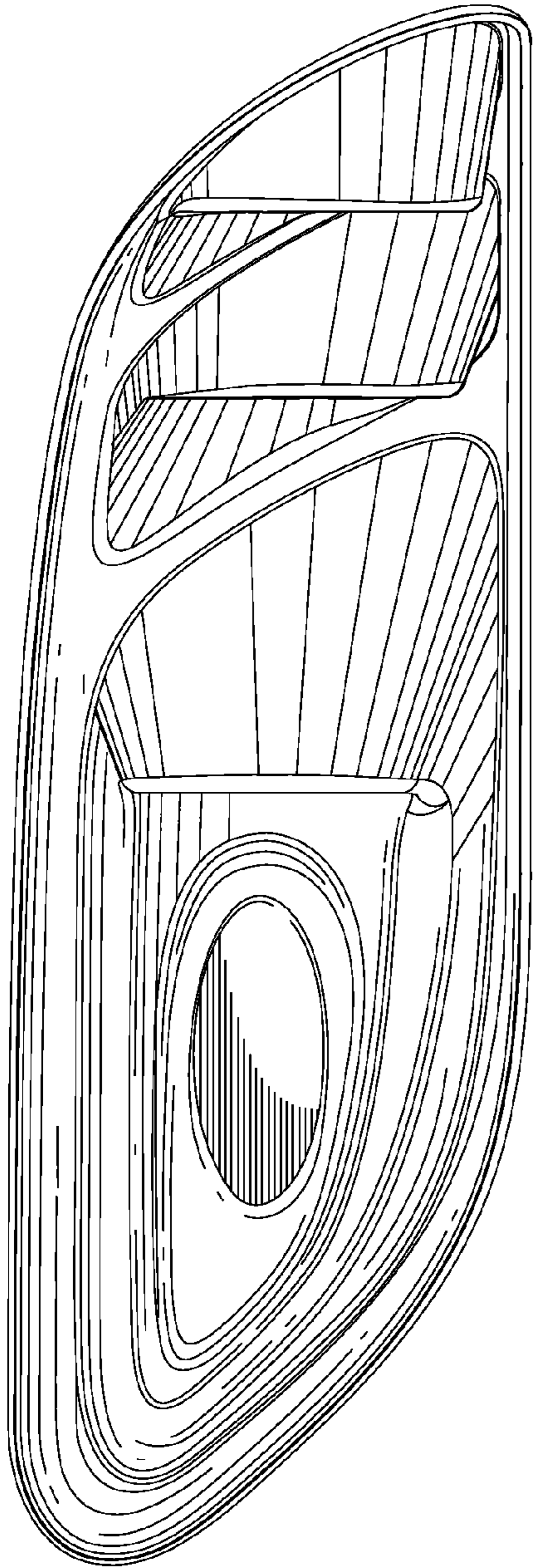

Fig. 6.

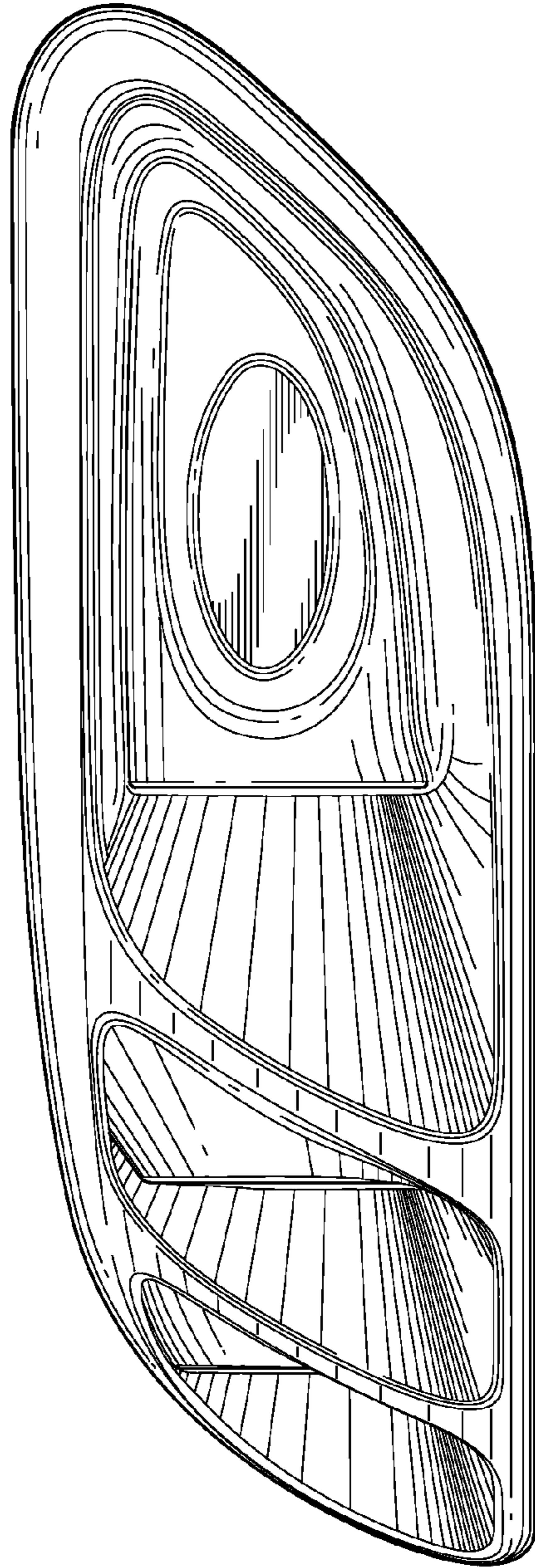

Fig. 7.

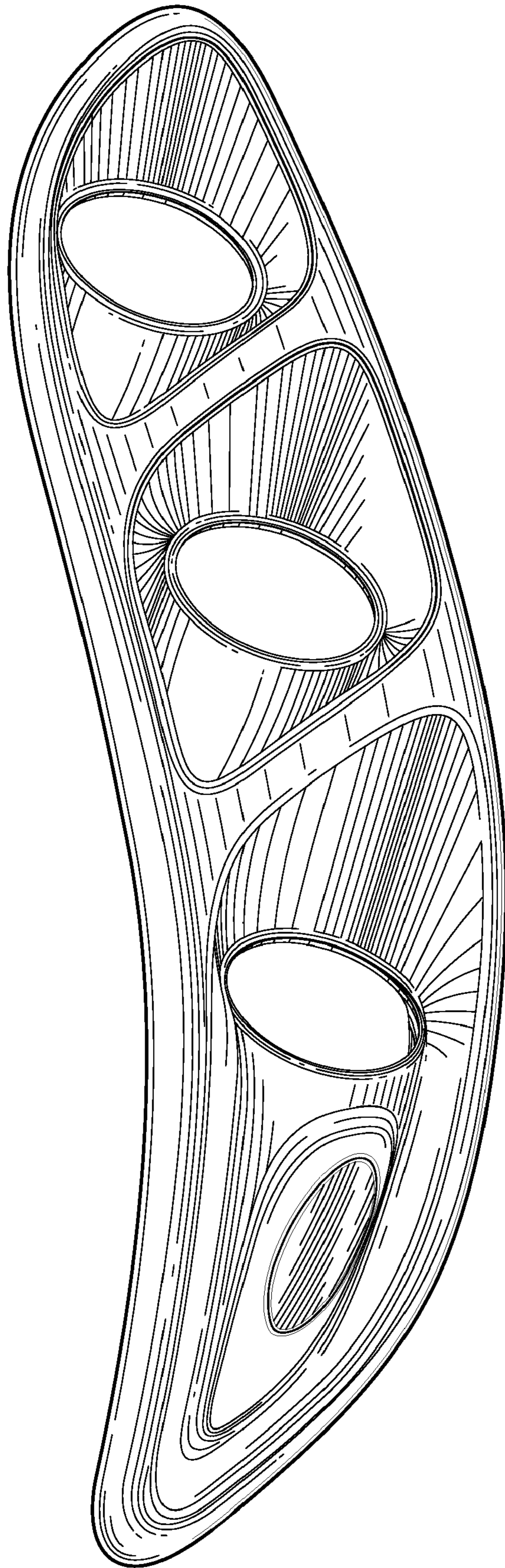

Fig. 8.

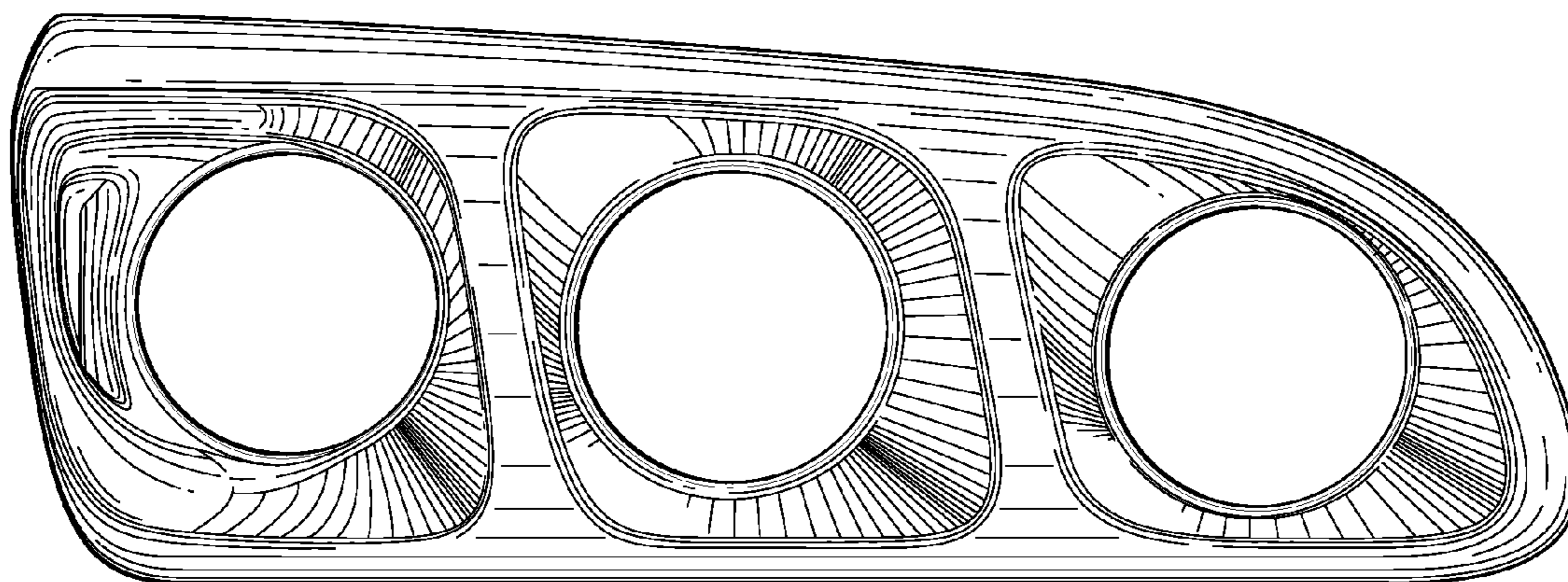

Fig. 9.

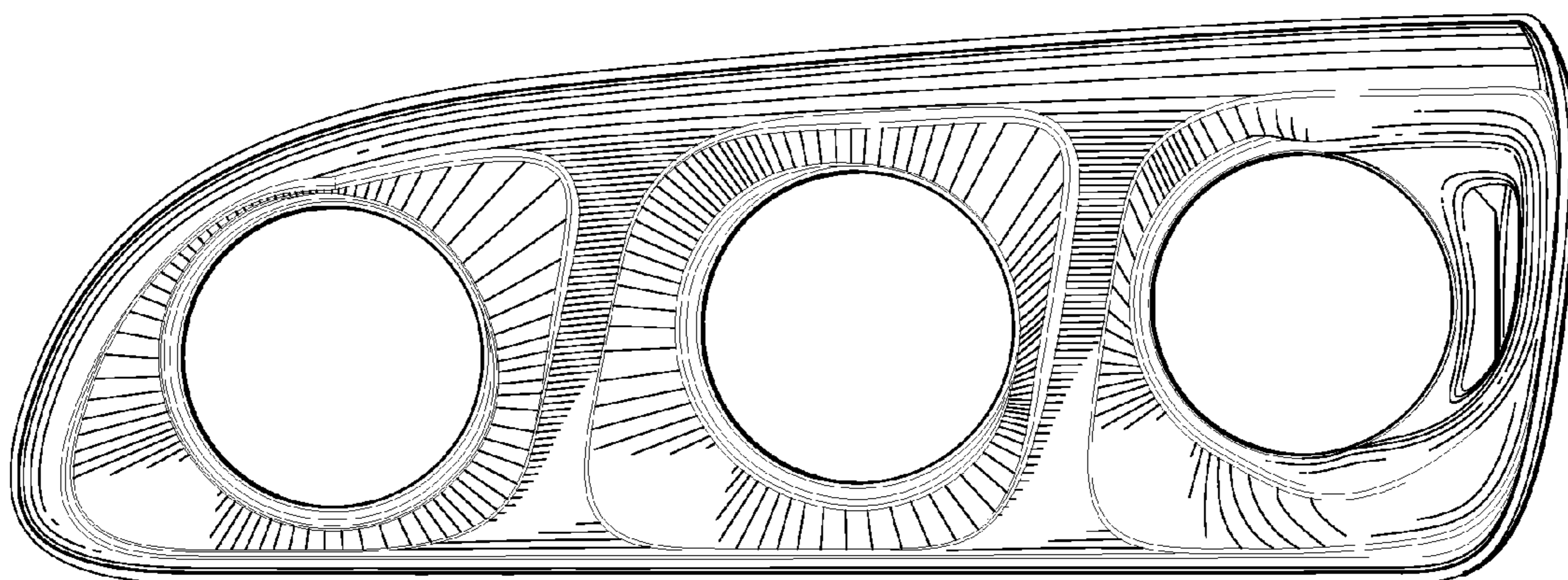

Fig. 10.

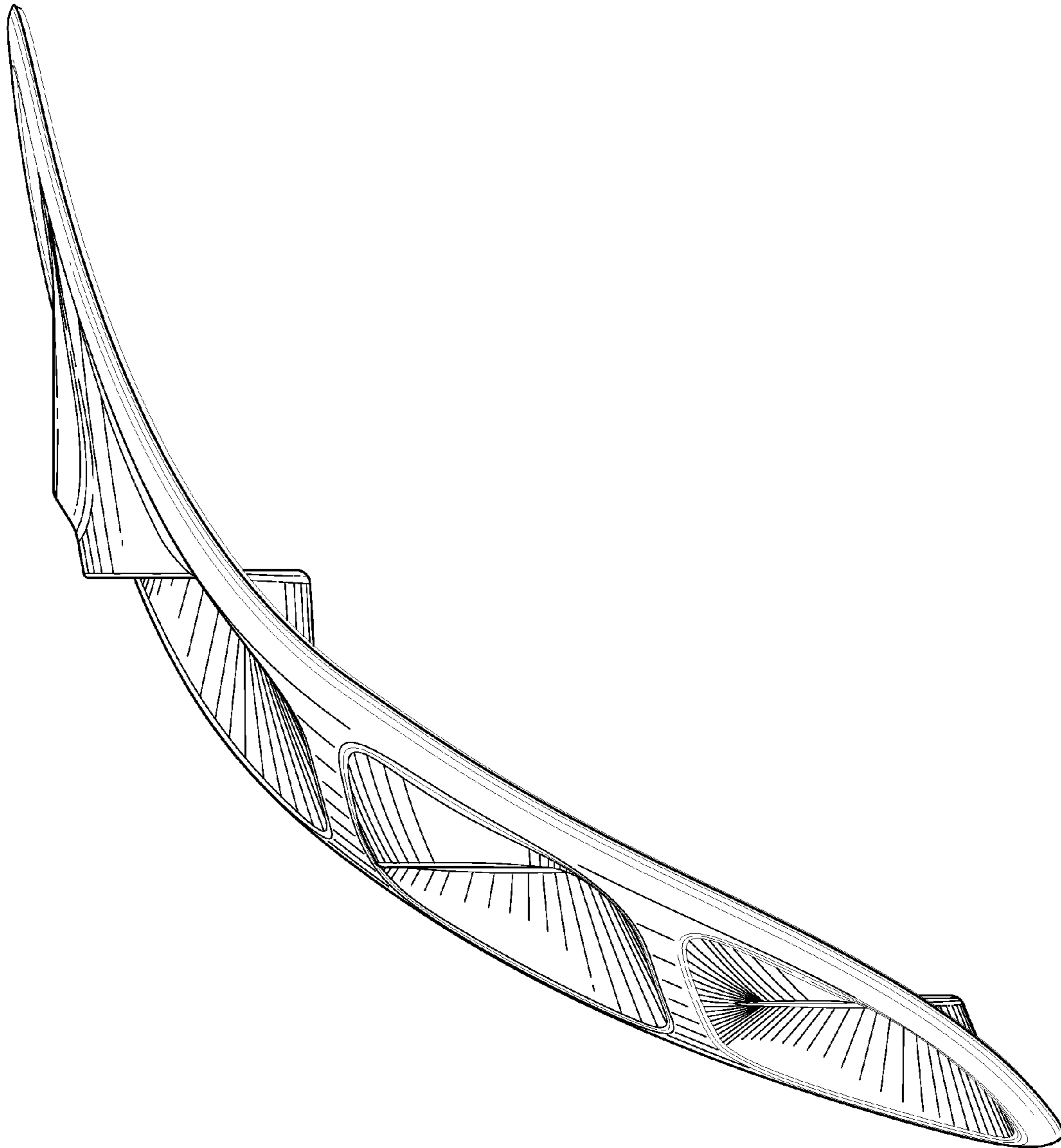

Fig. 11.

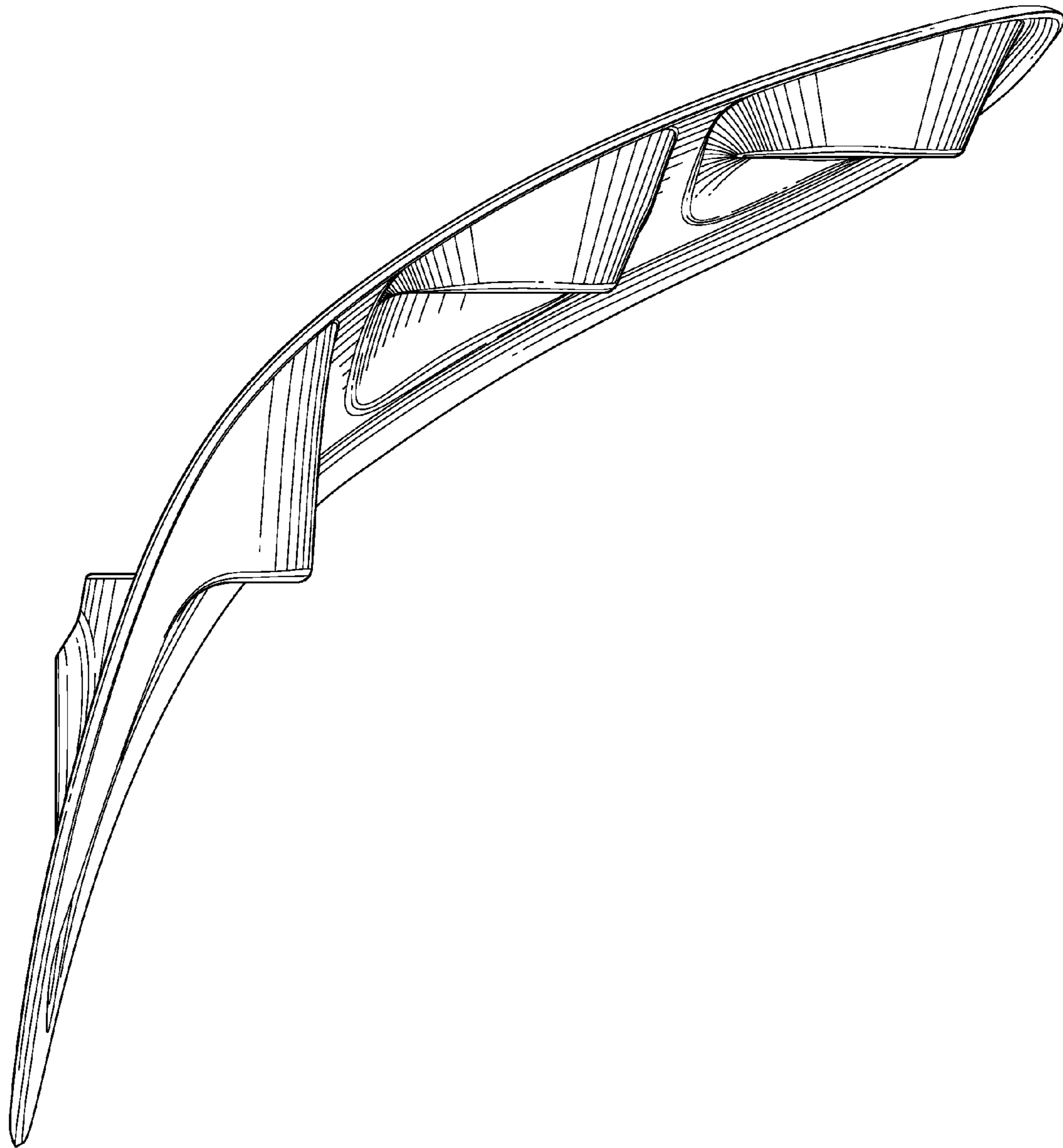

Fig. 12.

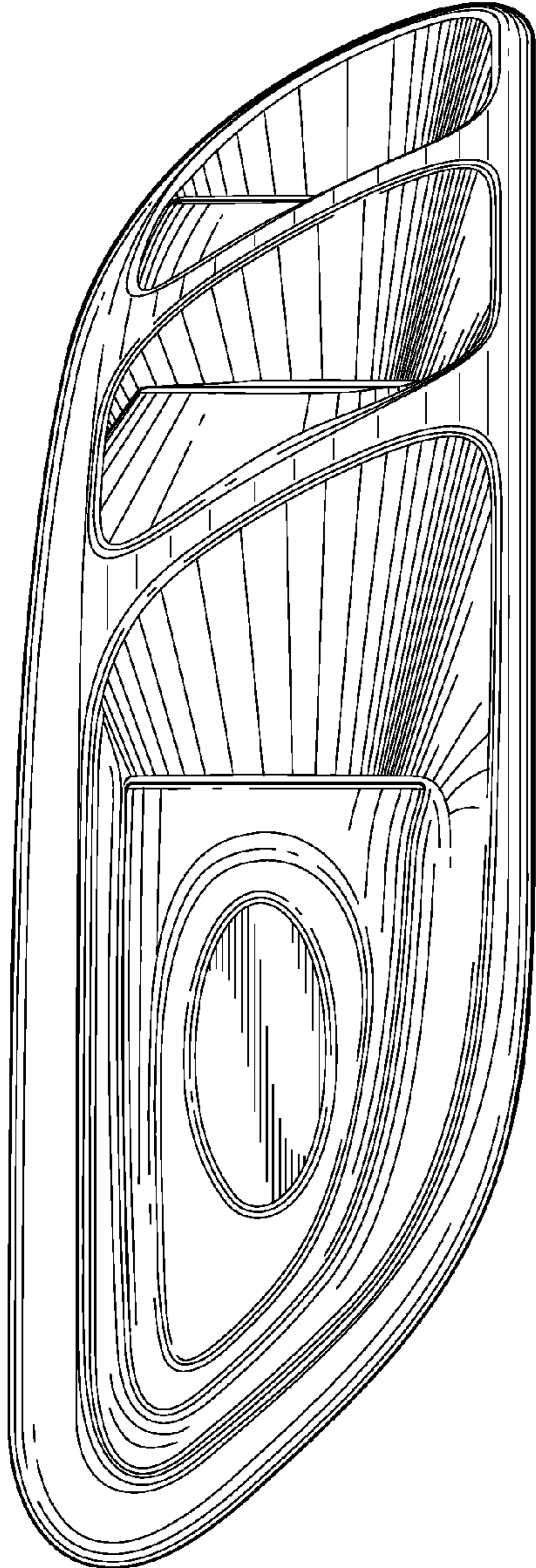

Fig. 13.

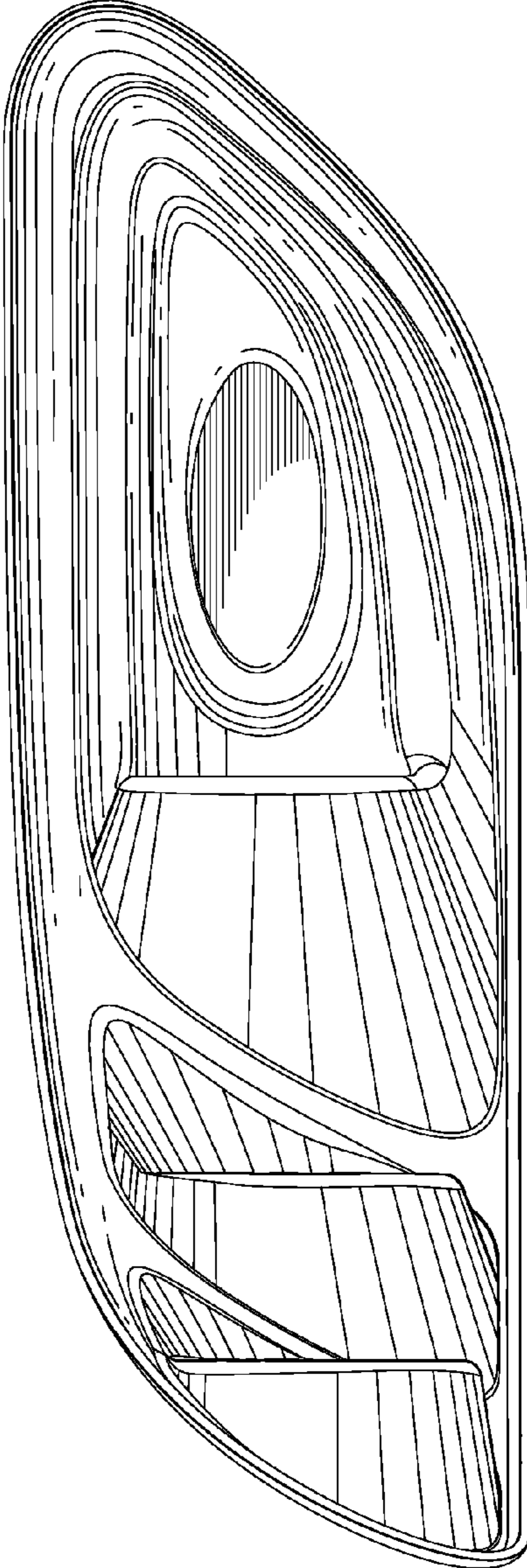

Fig. 14.