



US00D564094S

(12) **United States Design Patent**
Hayashi

(10) **Patent No.:** **US D564,094 S**
(45) **Date of Patent:** **** Mar. 11, 2008**

- (54) **PROCESSOR FOR ENDOSCOPE**
- (75) Inventor: **Tatsuyuki Hayashi**, Itabashi-ku (JP)
- (73) Assignee: **PENTAX Corporation**, Tokyo (JP)
- (**) Term: **14 Years**
- (21) Appl. No.: **29/273,086**
- (22) Filed: **Feb. 27, 2007**
- (30) **Foreign Application Priority Data**
Aug. 28, 2006 (JP) 2006-022668
- (51) **LOC (8) Cl.** **24-01**
- (52) **U.S. Cl.** **D24/138; D24/107; D24/144**
- (58) **Field of Classification Search** D24/138,
D24/107, 144, 186; 600/144, 170, 186, 178,
600/160, 179, 137, 138, 118
See application file for complete search history.

- D533,940 S * 12/2006 Hayamizu D24/138
- D534,654 S * 1/2007 Hayamizu D24/138
- D537,163 S * 2/2007 Nakamura D24/138

* cited by examiner

Primary Examiner—Ian Simmons
Assistant Examiner—Christopher Lee
(74) *Attorney, Agent, or Firm*—Sughrue Mion, PLLC

(57) **CLAIM**

The ornamental design for a processor for endoscope, as shown.

DESCRIPTION

FIG. 1 is a perspective view of the top, front and left side of a processor for endoscope showing my new design;
FIG. 2 is a front elevational view thereof;
FIG. 3 is a rear elevational view thereof;
FIG. 4 is a left side elevational view thereof;
FIG. 5 is a right side elevational view thereof;
FIG. 6 is a top plan view thereof; and,
FIG. 7 is a bottom plan view thereof.

(56) **References Cited**

U.S. PATENT DOCUMENTS

- D412,977 S * 8/1999 Hayamizu D24/107
- D481,123 S * 10/2003 Hayamizu D24/138
- 6,733,441 B2 * 5/2004 Niida et al. 600/178

1 Claim, 5 Drawing Sheets

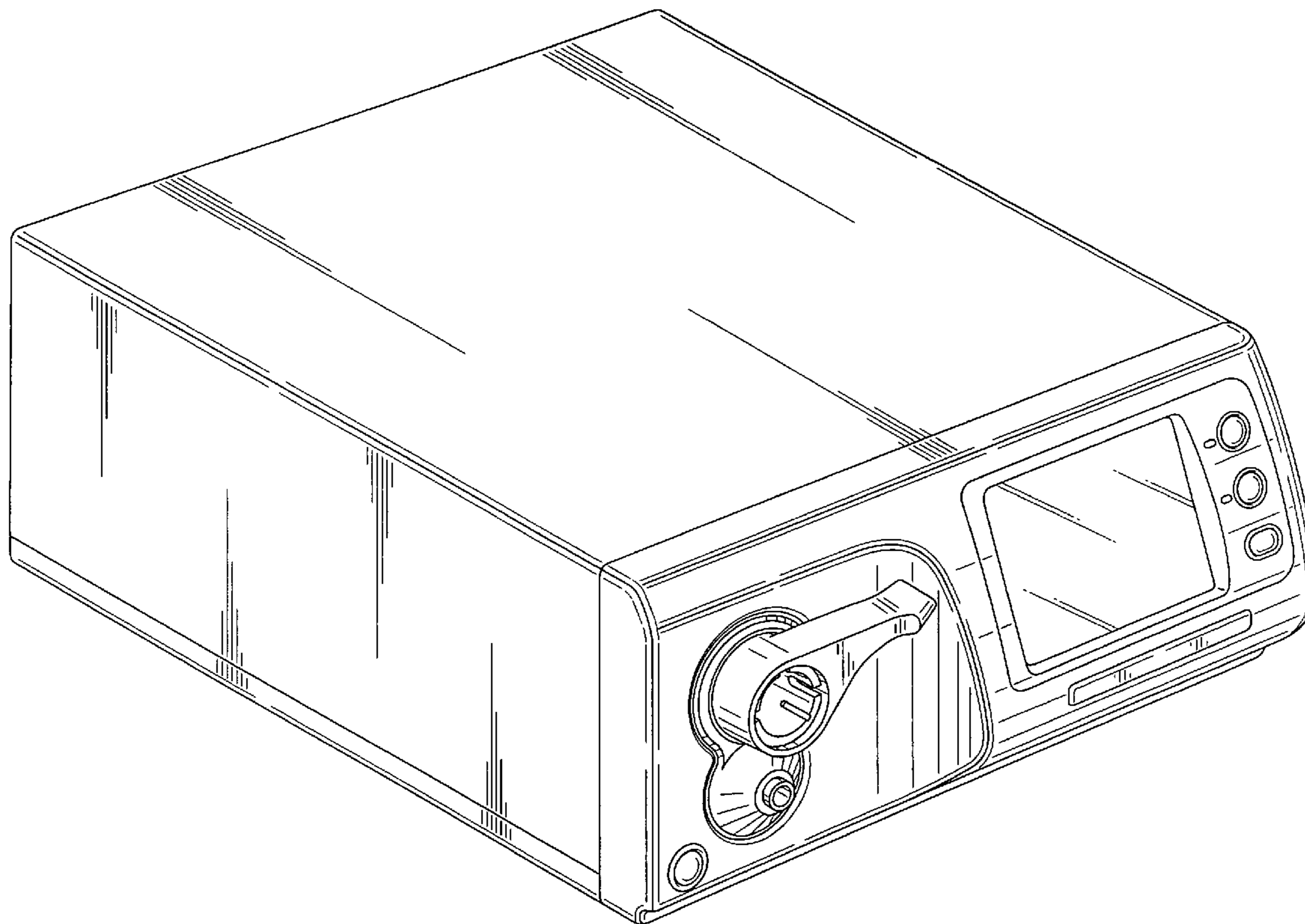

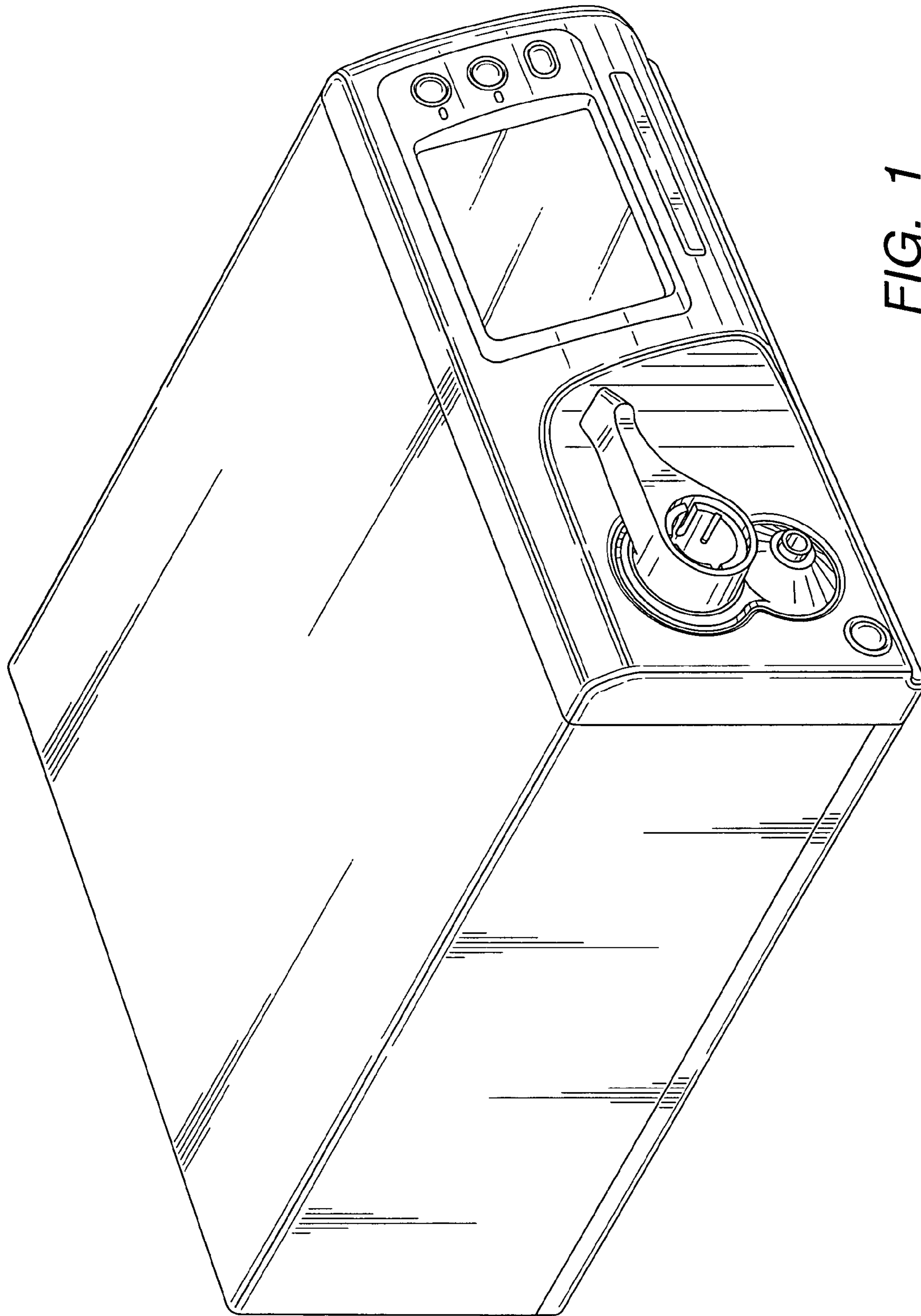

FIG. 1

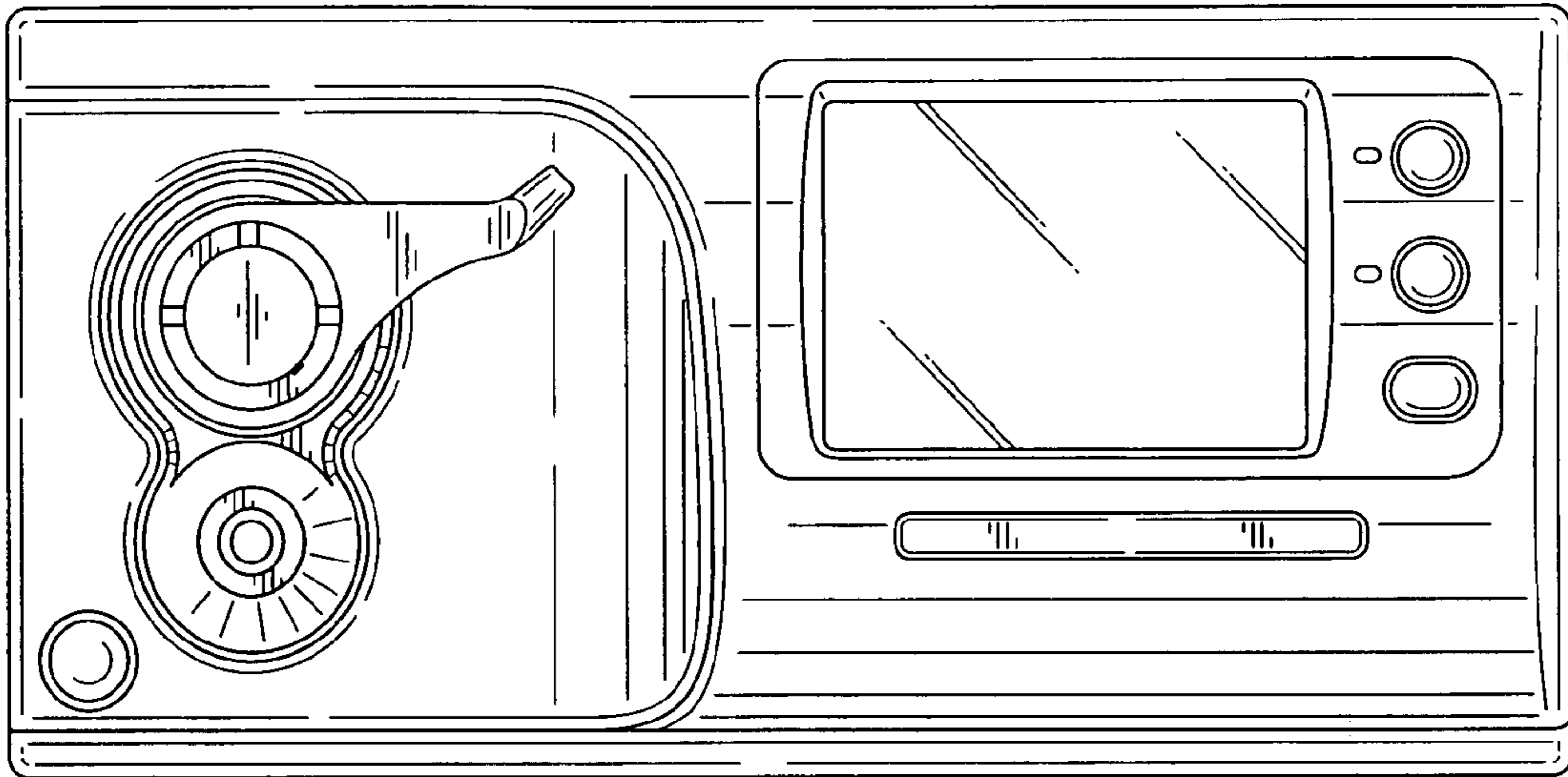

FIG. 2

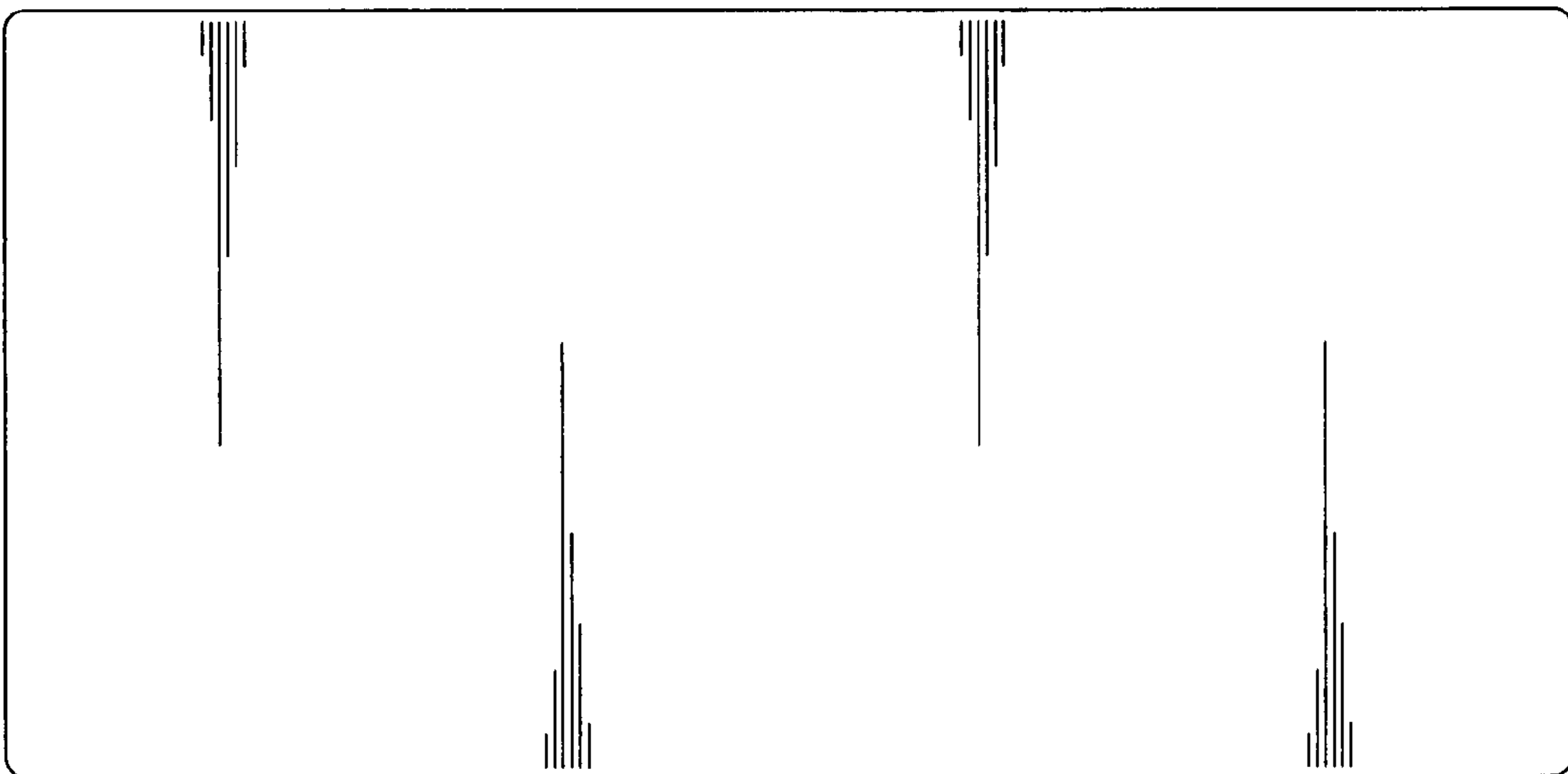

FIG. 3

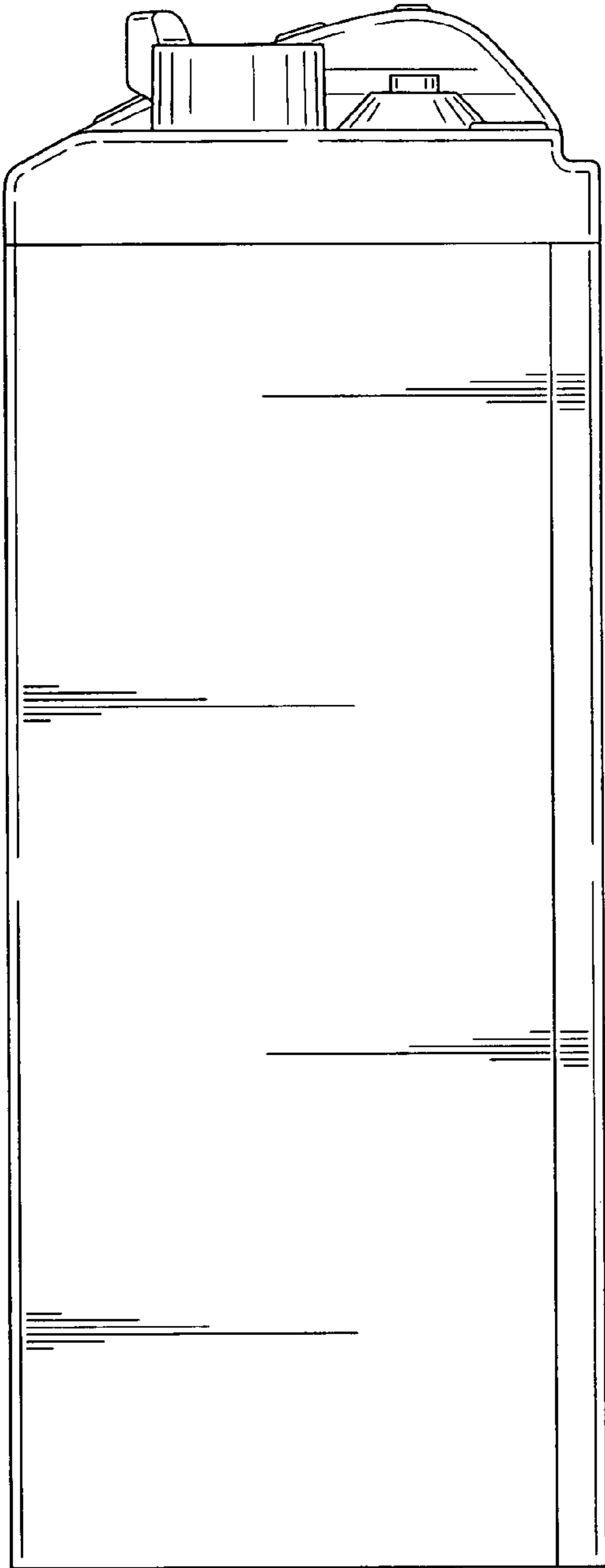

FIG. 4

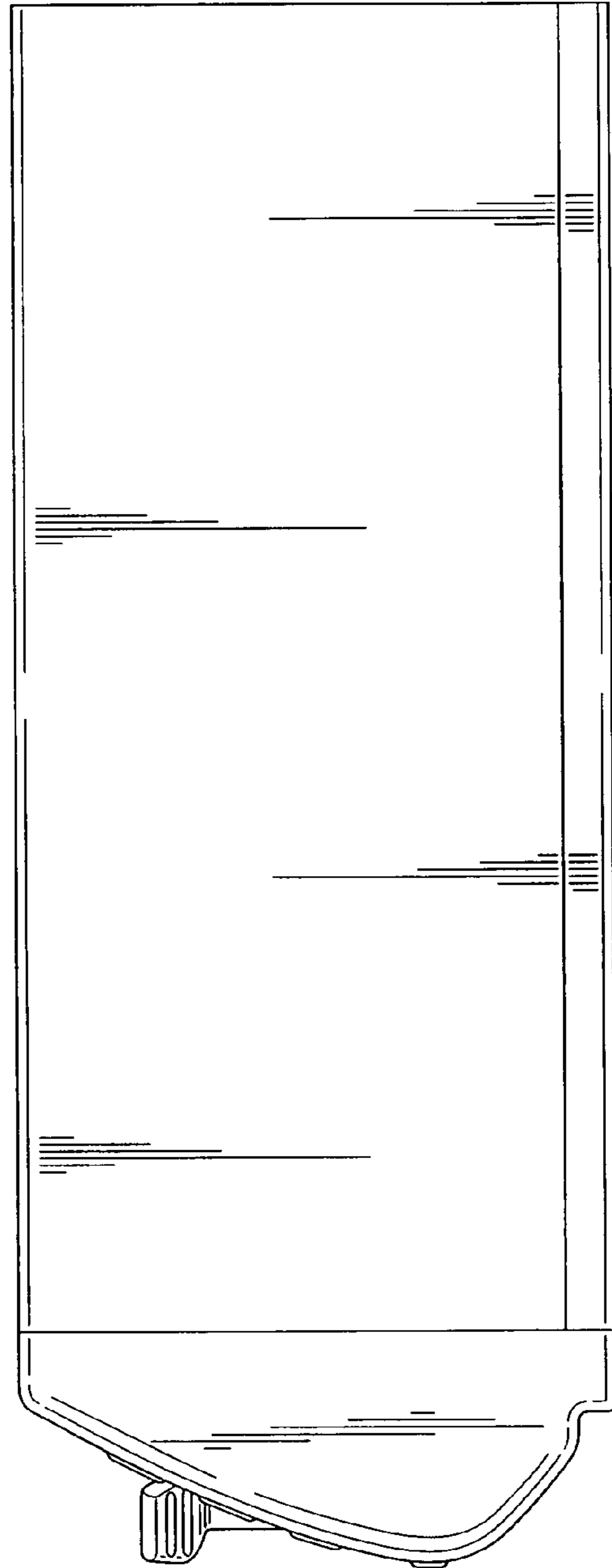

FIG. 5



FIG. 6

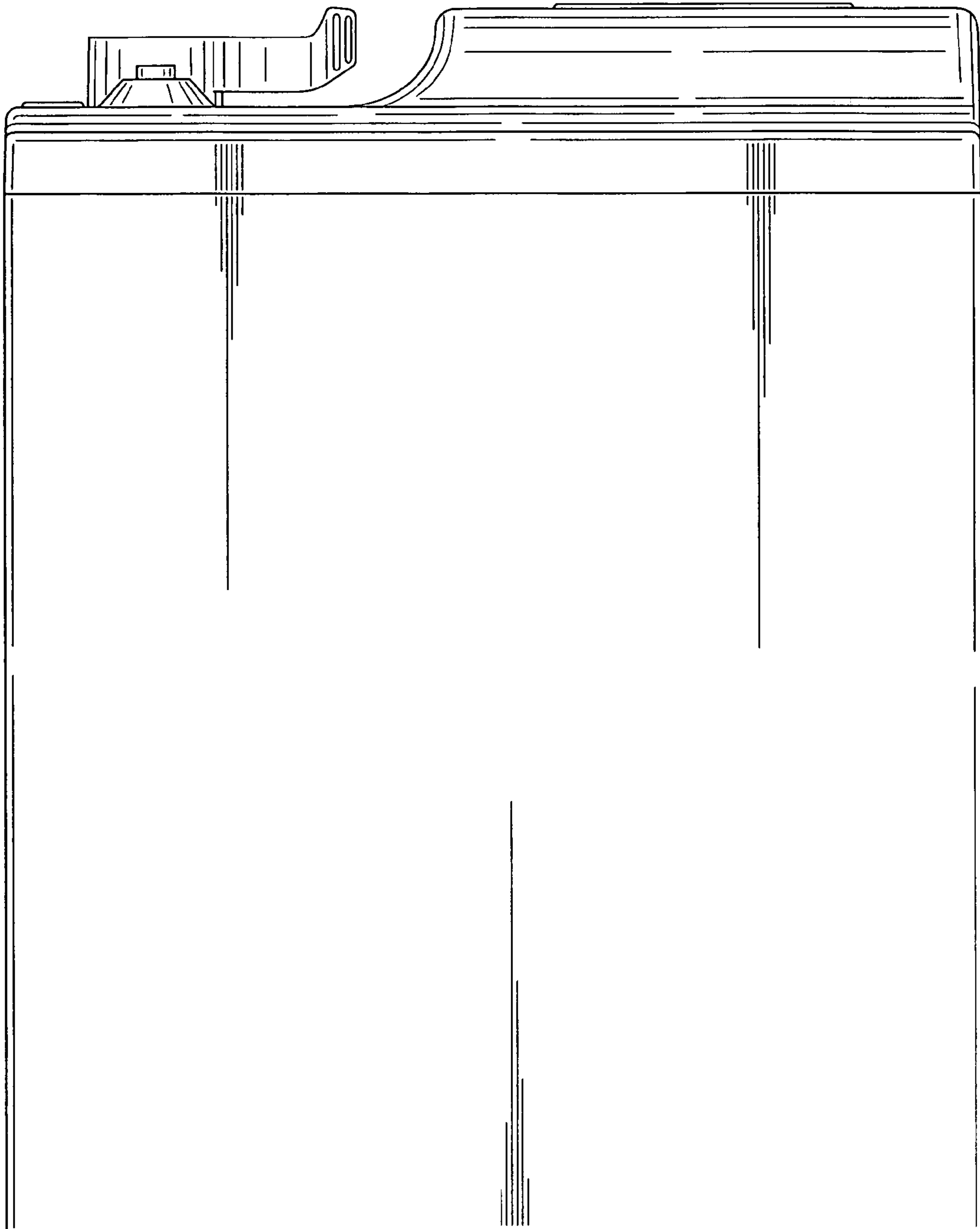

FIG. 7