



US00D564065S

(12) **United States Design Patent**
Yu

(10) **Patent No.:** **US D564,065 S**
(45) **Date of Patent:** **** Mar. 11, 2008**

(54) **HANDLE OF A PISTOL-TYPE NOZZLE**

(74) *Attorney, Agent, or Firm*—Egbert Law Offices

(75) Inventor: **Pin-Hsien Yu**, Taipei (TW)

(57) **CLAIM**

(73) Assignee: **Aqualean Manufacturing Associates**,
Taipei (TW)

The ornamental design for a handle of a pistol-type nozzle,
as shown and described.

(**) Term: **14 Years**

DESCRIPTION

(21) Appl. No.: **29/278,970**

FIG. 1 is an upper perspective view of the handle of a
pistol-type nozzle showing my design.

(22) Filed: **Apr. 16, 2007**

FIG. 2 is a front view thereof;

(51) **LOC (8) Cl.** **23-01**

FIG. 3 is a back view thereof;

(52) **U.S. Cl.** **D23/223**

FIG. 4 is a side view thereof;

(58) **Field of Classification Search** D23/213,
D23/223, 226; 239/394, 525–526
See application file for complete search history.

FIG. 5 is an opposite side view thereof;

FIG. 6 is a top plan view thereof;

FIG. 7 is a bottom view thereof;

(56) **References Cited**

U.S. PATENT DOCUMENTS

D387,849 S	*	12/1997	Wang	D23/223
D498,515 S	*	11/2004	Wilson	D23/223
D502,533 S	*	3/2005	Chen	D23/226
D548,392 S	*	8/2007	Lo et al.	D23/226
D554,231 S	*	10/2007	Chih	D23/213

FIG. 8 is a rear perspective view thereof;

FIG. 9 is another perspective view thereof, showing align-
ment of an attachment in broken lines; and,

FIG. 10 is a perspective view thereof, showing connection of
the attachment of FIG. 9 in broken lines.

The portions shown in broken lines are presented for illus-
trative purposes only and form no part of the claimed design.

* cited by examiner

Primary Examiner—Robin V Webster

1 Claim, 9 Drawing Sheets





FIG.1

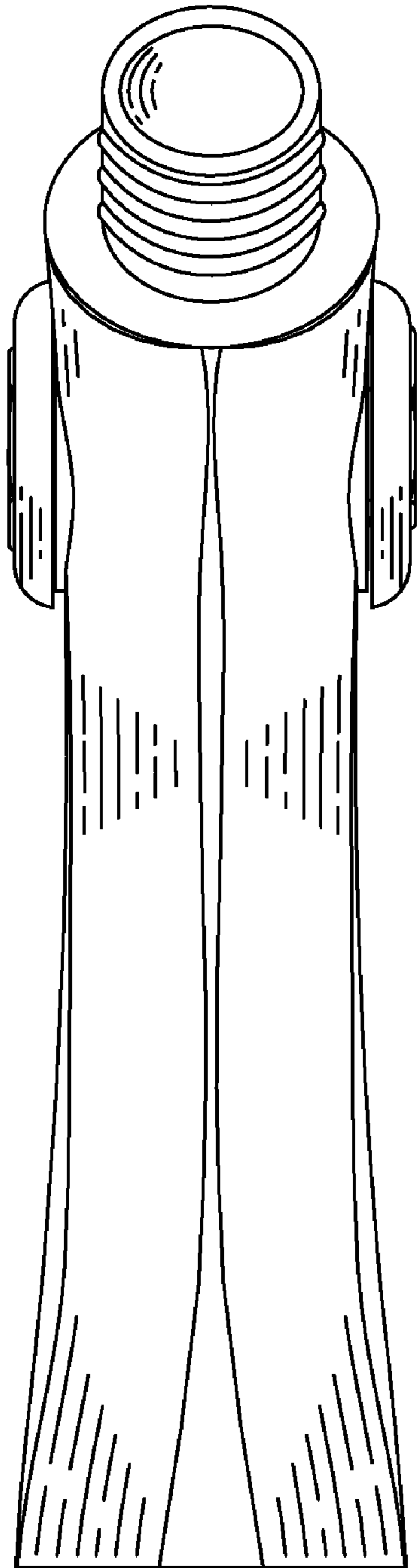

FIG.2

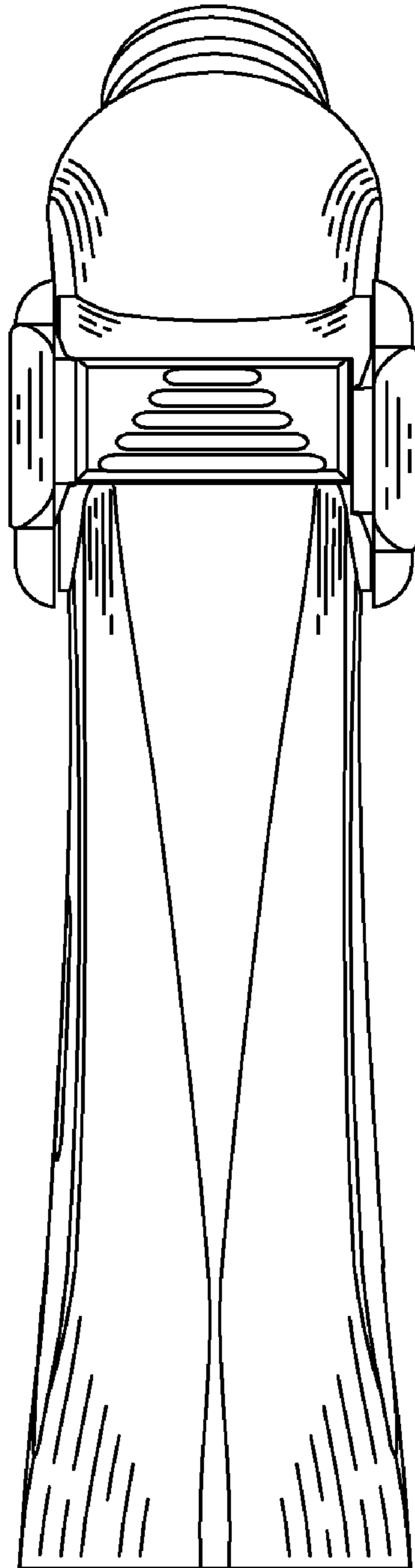

FIG.3

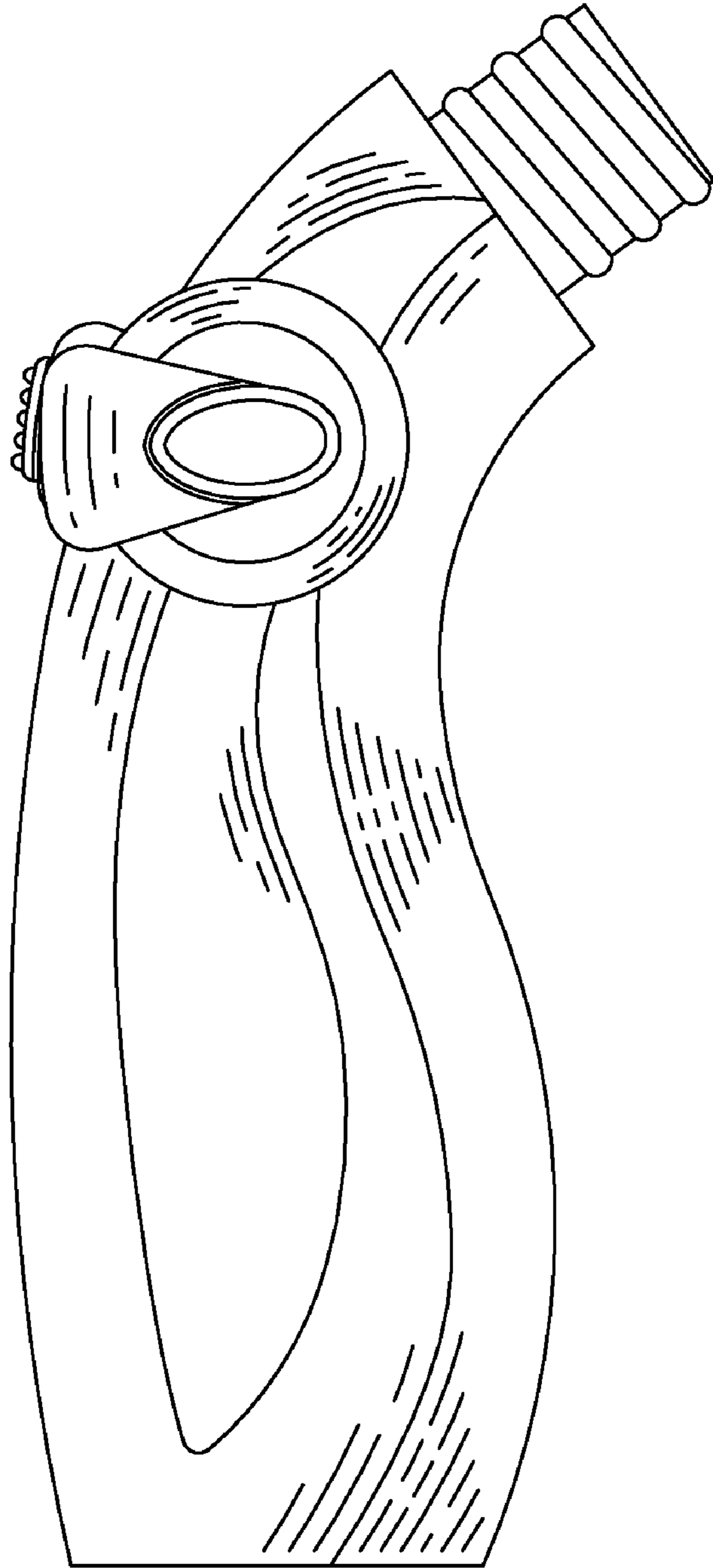

FIG.4

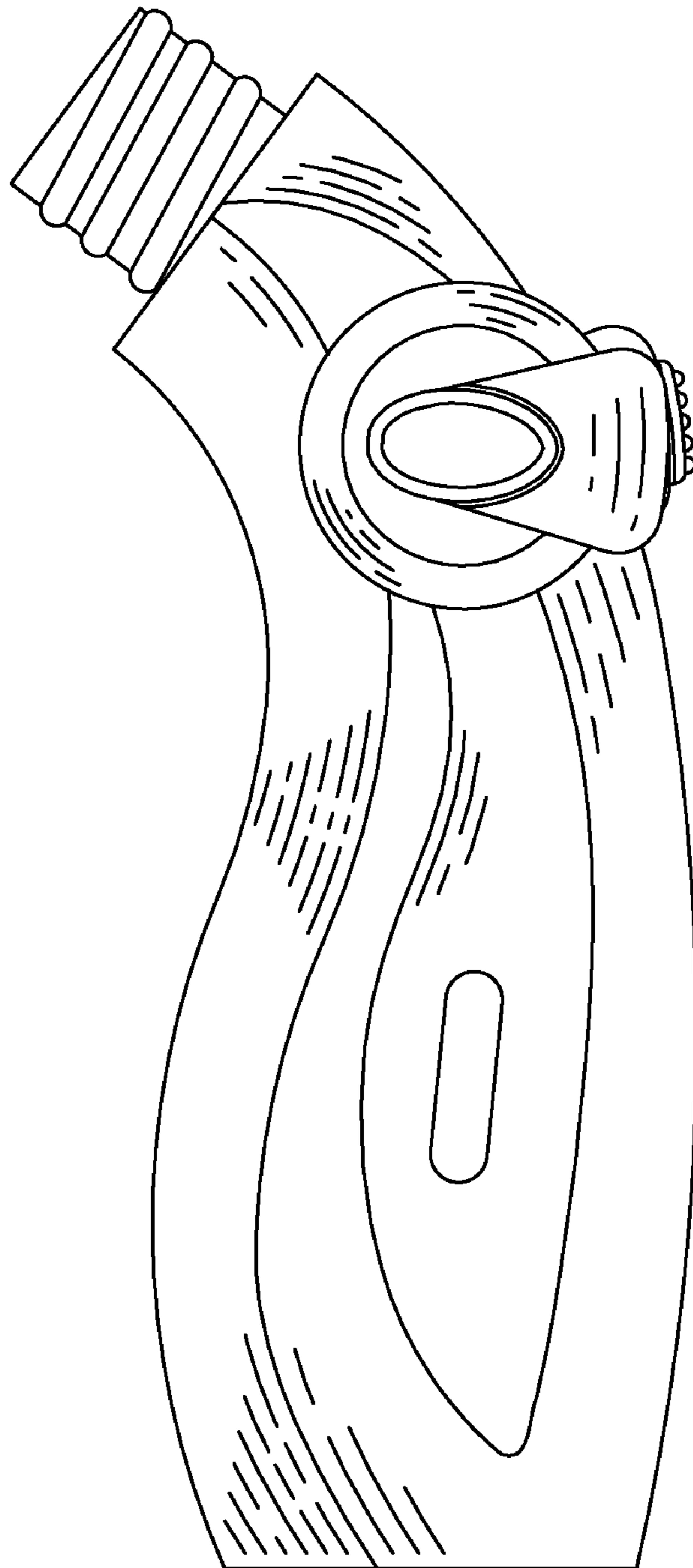

FIG.5

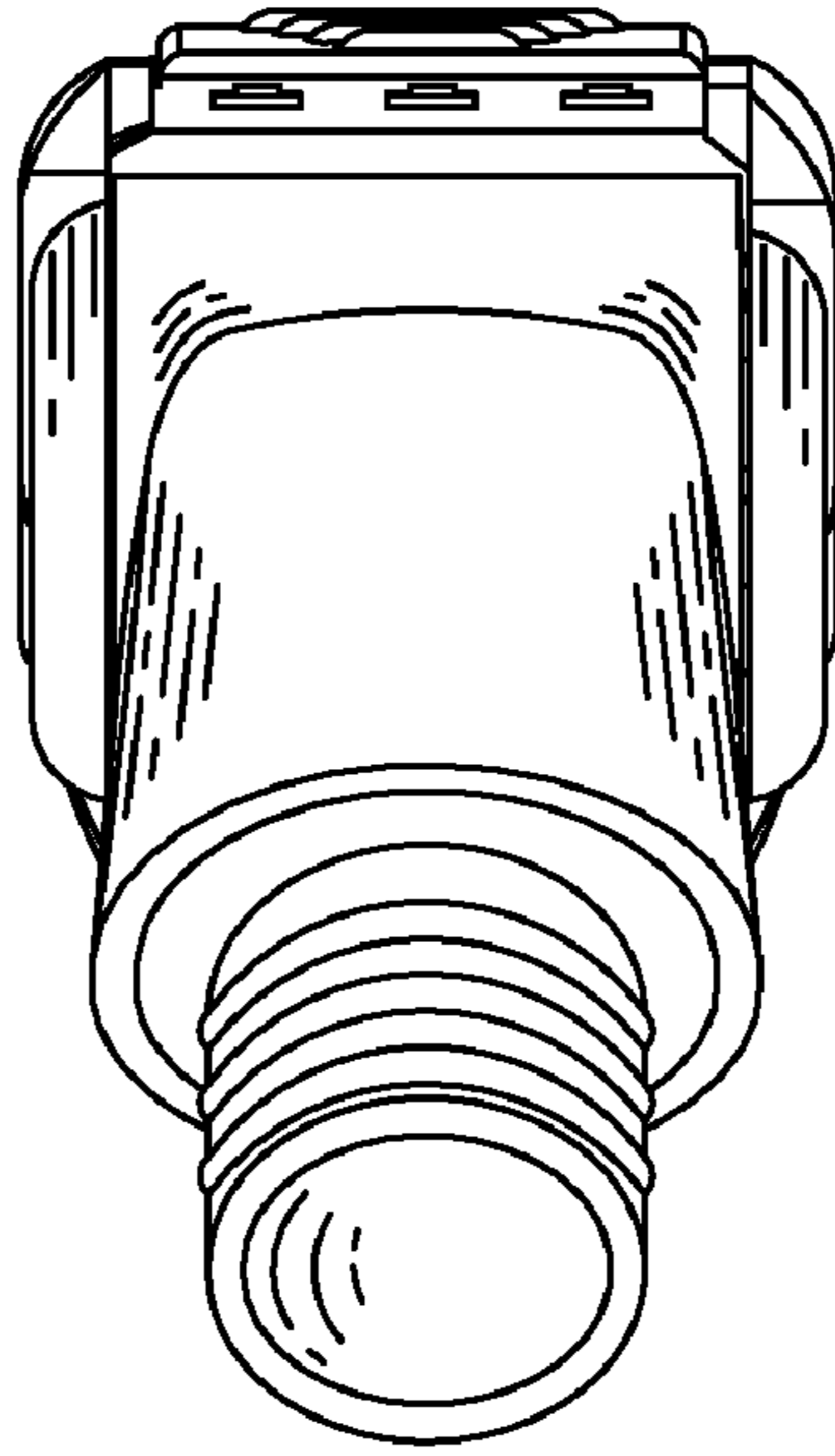

FIG. 6

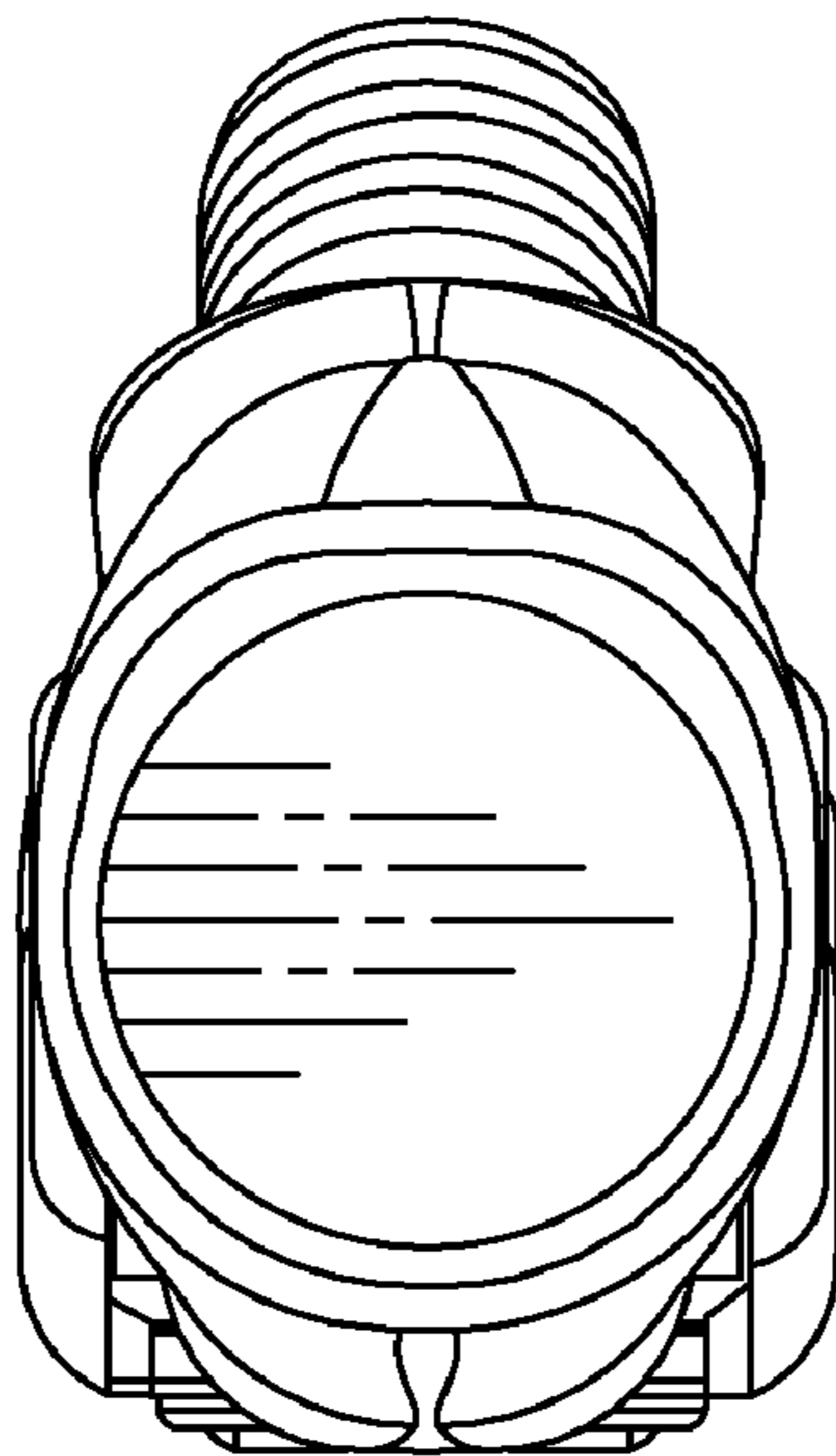

FIG. 7



FIG.8

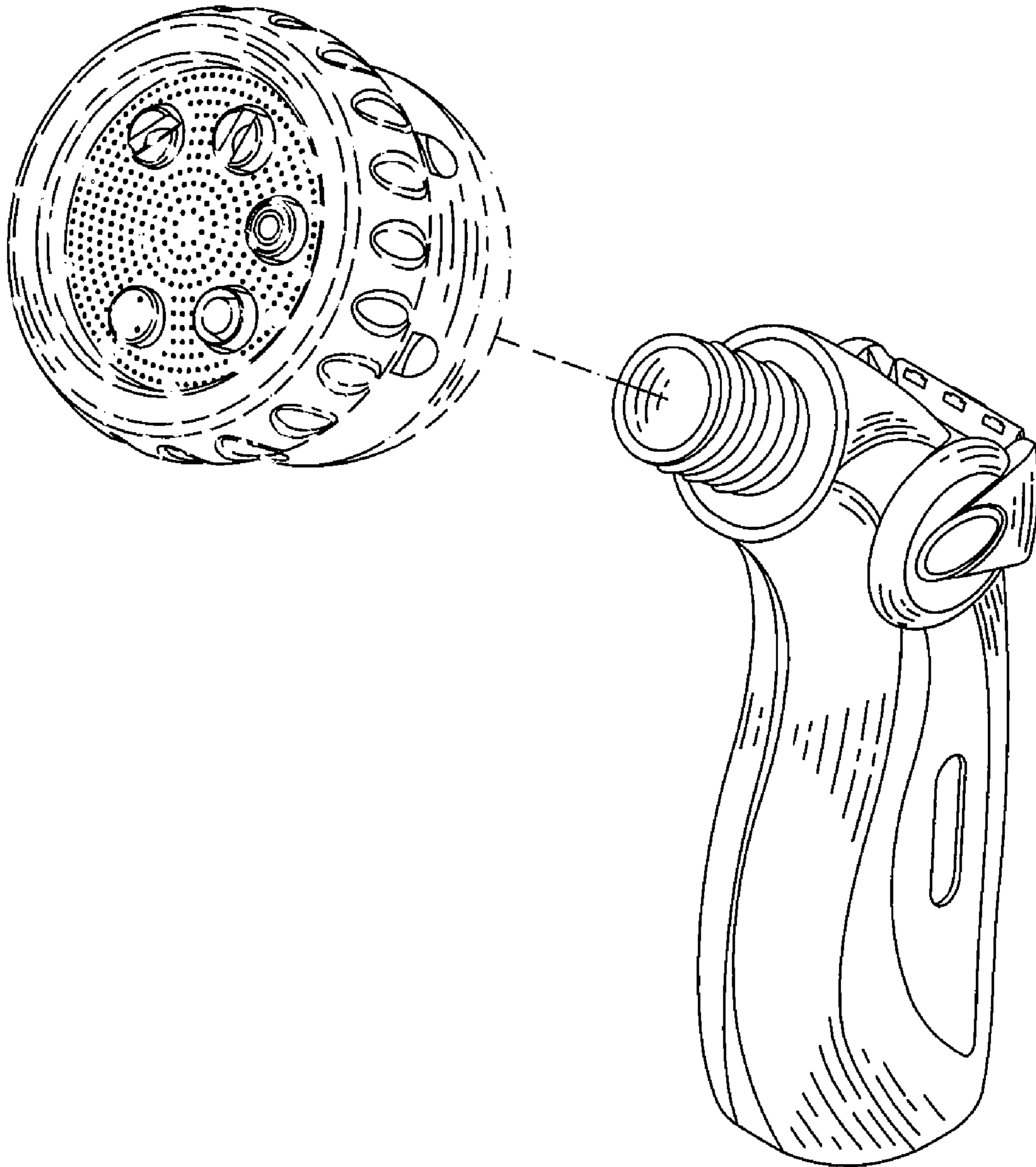

FIG. 9

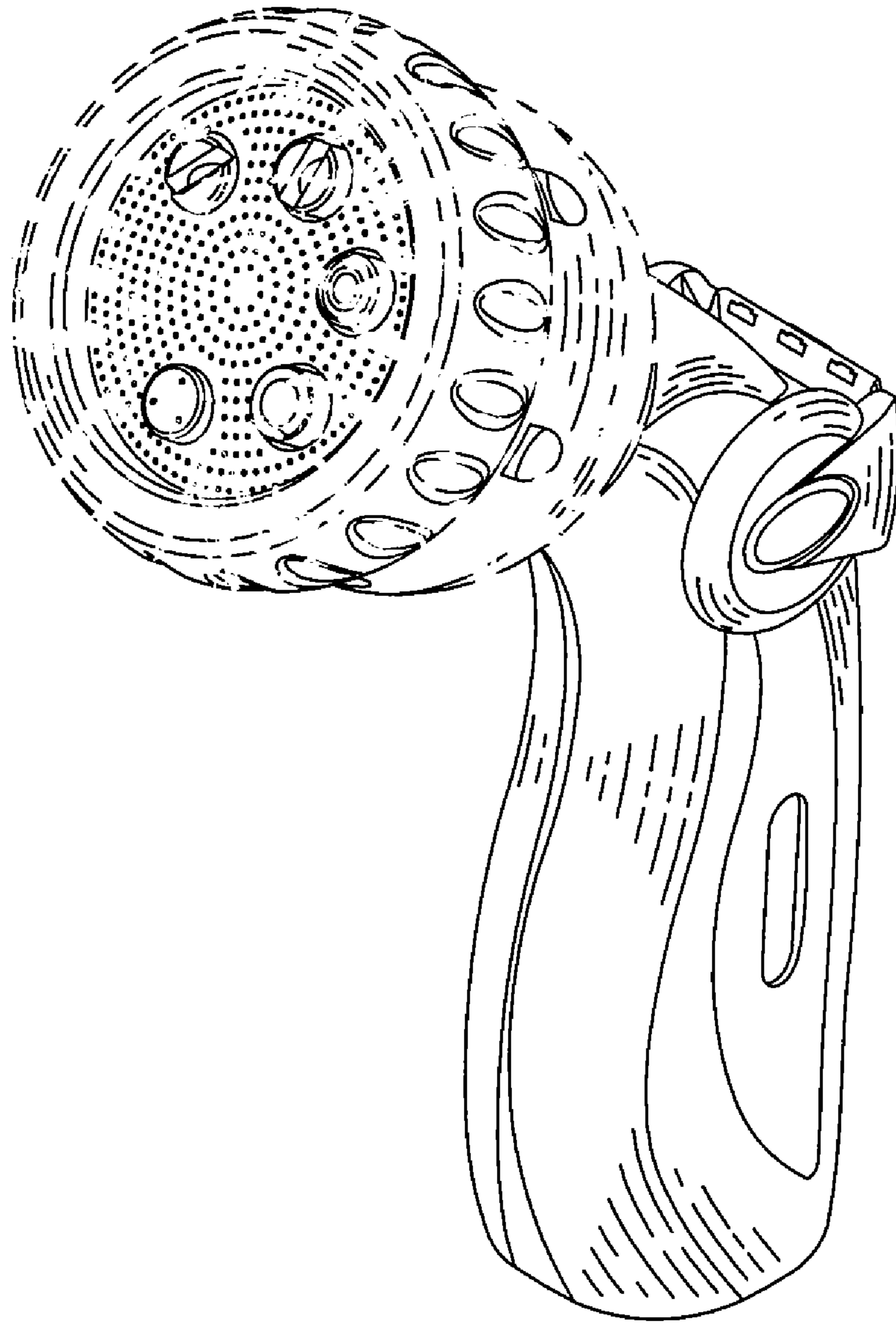

FIG.10