

US00D563942S

(12) **United States Design Patent**  
**Tejima**

(10) **Patent No.:** **US D563,942 S**  
(45) **Date of Patent:** **\*\* Mar. 11, 2008**

(54) **COMBINED DISC RECORDER AND HARD DISC DRIVE**

D547,285 S \* 7/2007 Yoshida ..... D14/136

(75) Inventor: **Keisuke Tejima**, Tokyo (JP)

(73) Assignee: **Sony Corporation**, Tokyo (JP)

(\*\*) Term: **14 Years**

(21) Appl. No.: **29/270,575**

(22) Filed: **Dec. 28, 2006**

(30) **Foreign Application Priority Data**

Sep. 8, 2006 (JP) ..... D2006-024053

(51) **LOC (8) Cl.** ..... **14-01**

(52) **U.S. Cl.** ..... **D14/168; D14/496**

(58) **Field of Classification Search** ..... D14/135-136,  
D14/156-157, 167-168, 496, 198, 188, 217,  
D14/257, 258, 445; 360/99.02, 99.07; 369/75.11,  
369/75.21, 77.21, 77.11; 720/612, 619, 647,  
720/655; 455/344, 347-351

See application file for complete search history.

(56) **References Cited**

**U.S. PATENT DOCUMENTS**

- 5,859,828 A \* 1/1999 Ishibashi ..... 720/655
- D459,709 S \* 7/2002 Kojima et al. .... D14/136
- D485,245 S \* 1/2004 Shiraki et al. .... D14/136
- D524,775 S \* 7/2006 Liu ..... D14/136
- D530,689 S 10/2006 Ishibashi
- D531,151 S 10/2006 Yoshida
- D531,590 S 11/2006 Maeyama

**FOREIGN PATENT DOCUMENTS**

- CN 3550873 S 8/2005
- JP D1120307 S 9/2001
- JP D1183527 S 9/2003
- JP D1200280 S 3/2004

\* cited by examiner

*Primary Examiner*—Nanda Bondade

(74) *Attorney, Agent, or Firm*—Rader, Fishman & Grauer, PLLC

(57) **CLAIM**

The ornamental design for a combined disc recorder and hard disc drive, as shown and described.

**DESCRIPTION**

FIG. 1 is a perspective view of a combined disc recorder and hard disc drive showing my new design.

FIG. 2 is a front elevational view thereof;

FIG. 3 is a left side elevational view thereof;

FIG. 4 is a right side elevational view thereof; and

FIG. 5 is a top plan view thereof.

FIG. 6 is a bottom plan view thereof; and,

FIG. 7 is a rear elevational view thereof.

Portions shown as broken lines are for illustrative purpose only and form no part of the claimed design.

**1 Claim, 7 Drawing Sheets**

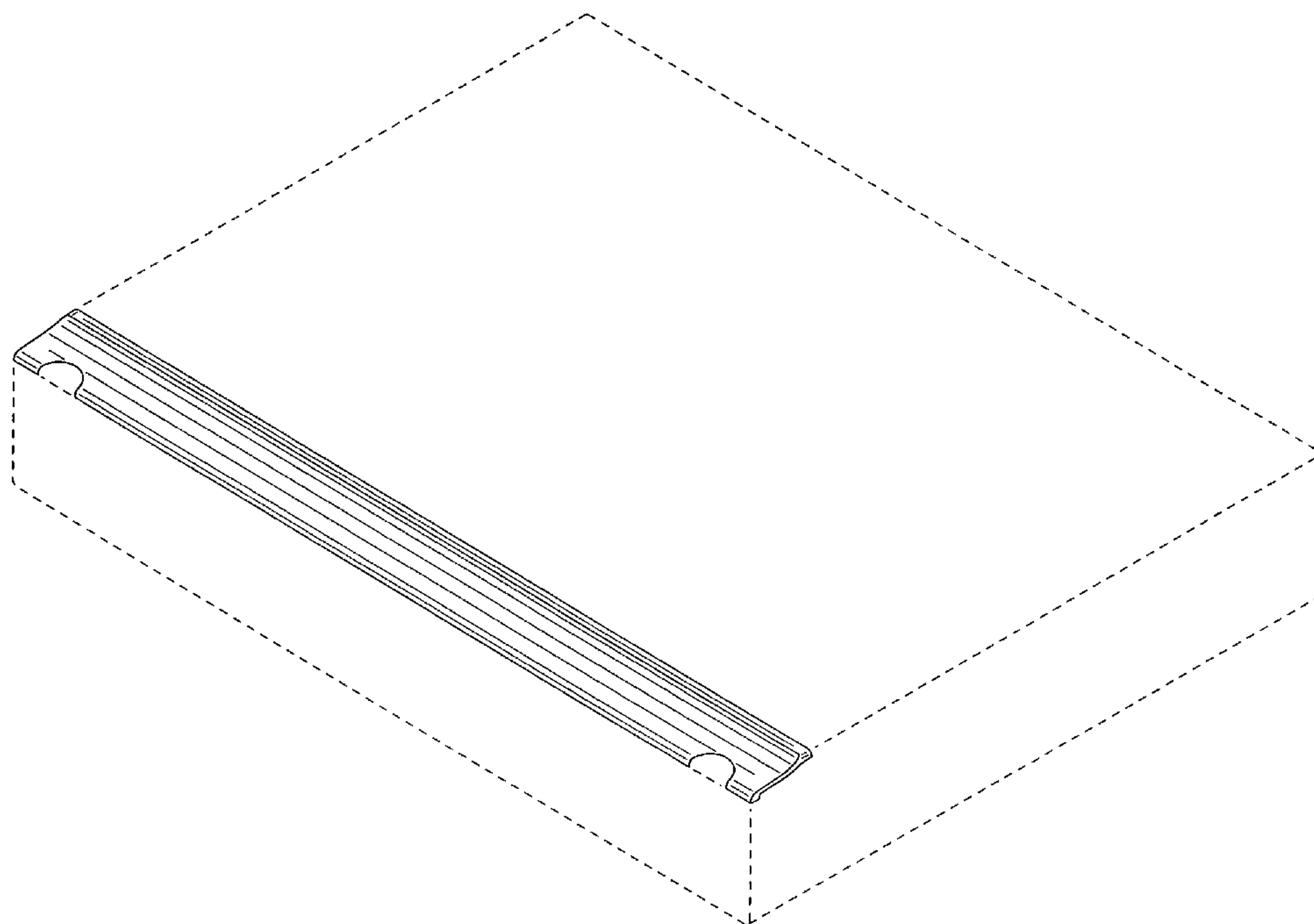

Fig.1

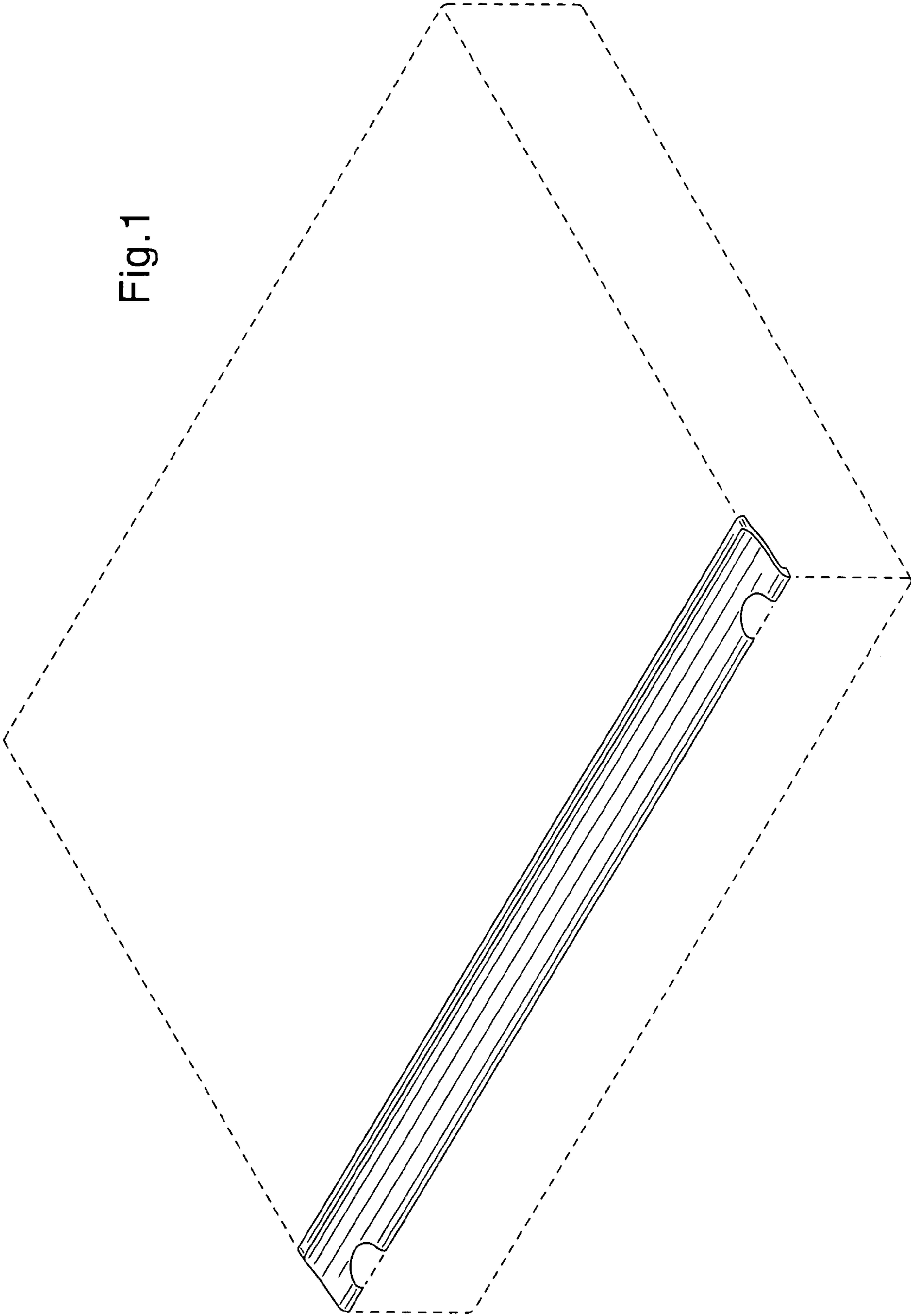

Fig.2

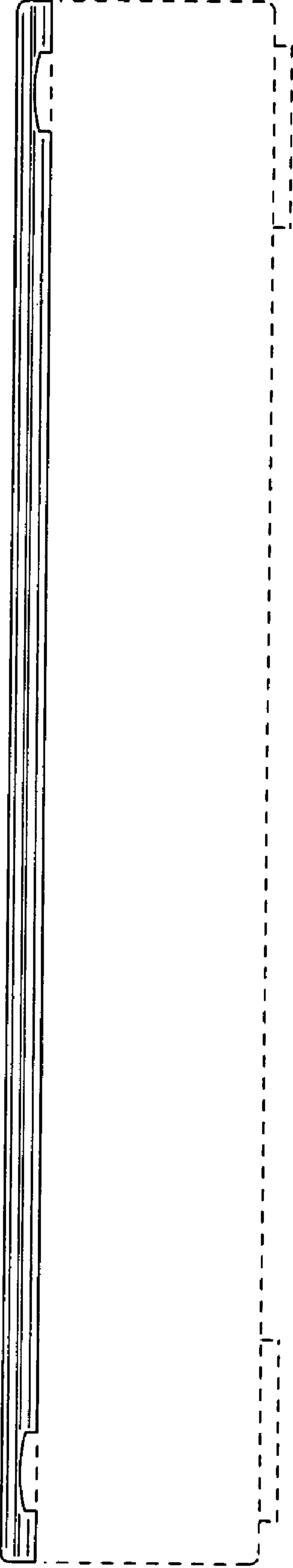

Fig. 3

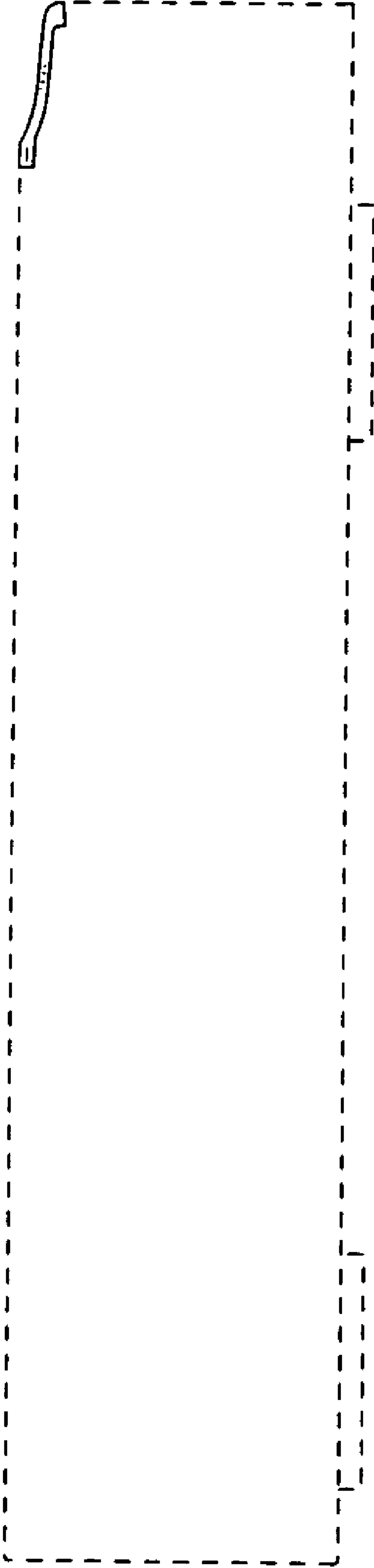
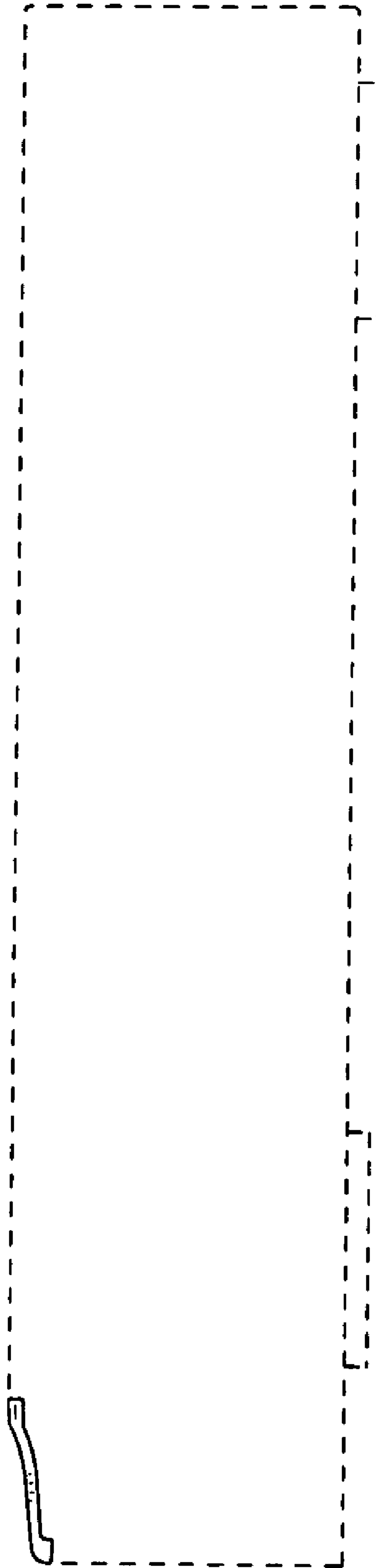

Fig.4



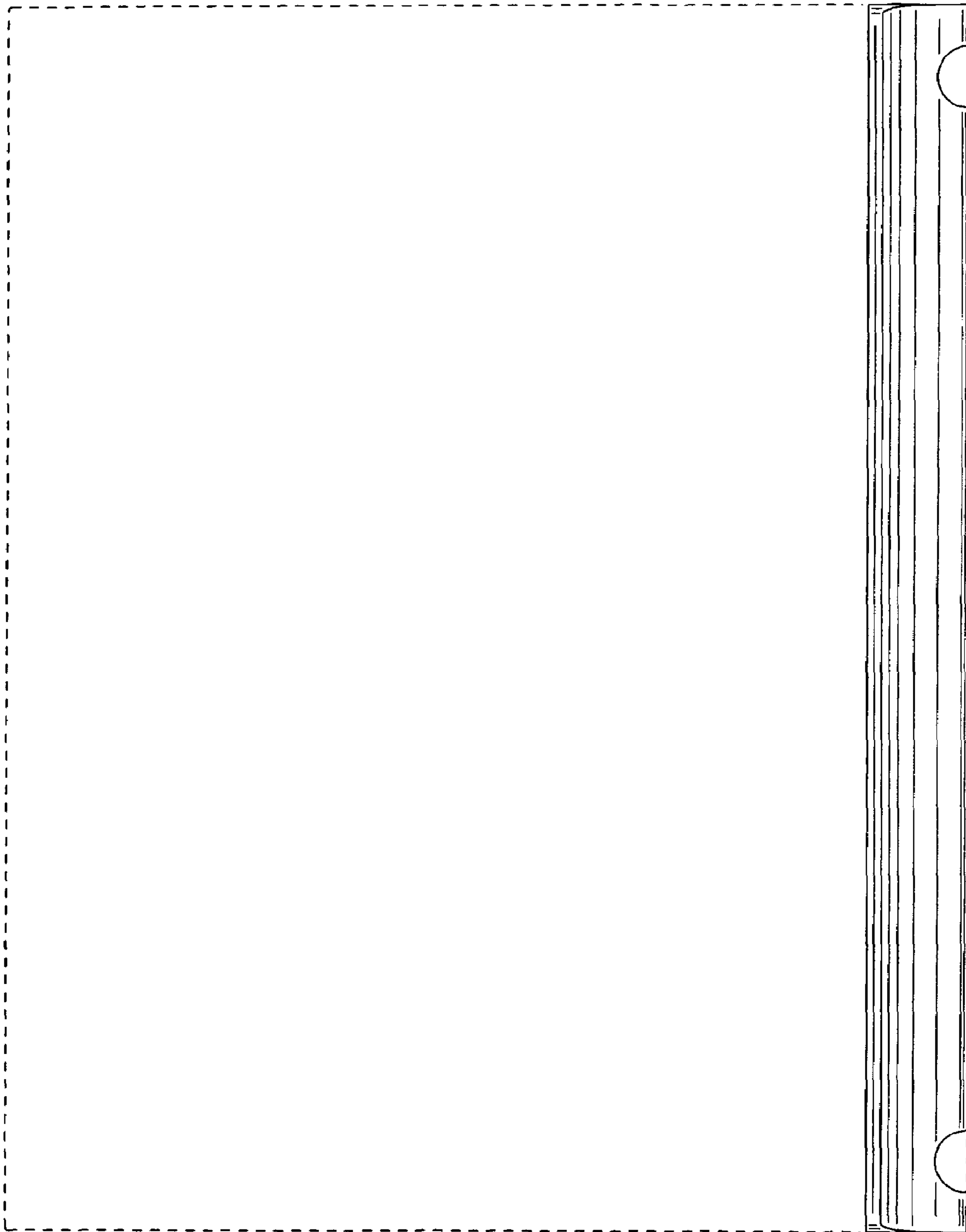

Fig.5

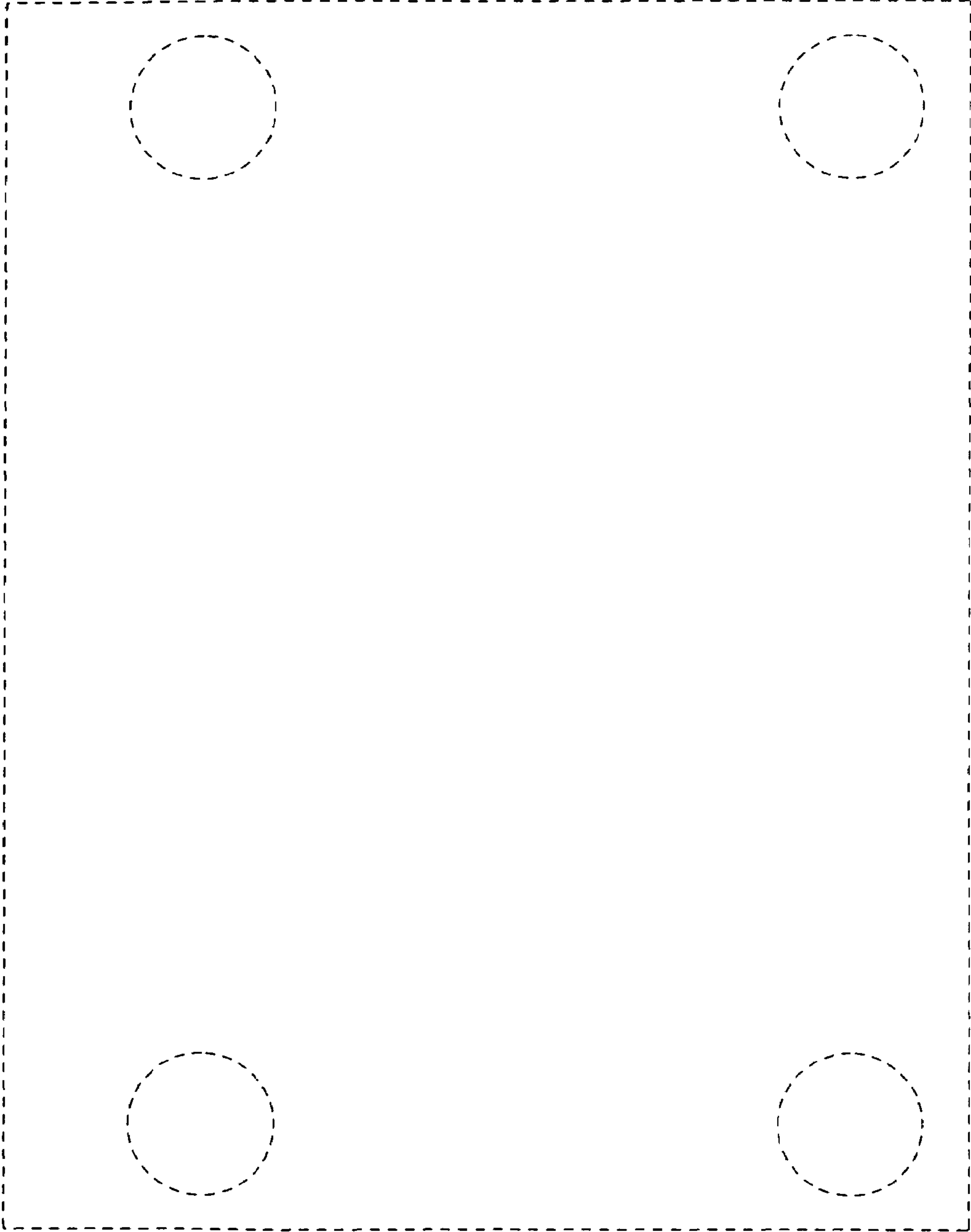

Fig.6

Fig.7

