



US00D563821S

(12) **United States Design Patent** (10) **Patent No.:** **US D563,821 S**
McKeever et al. (45) **Date of Patent:** **** Mar. 11, 2008**

(54) INTERCHANGEABLE ORNAMENT RING	5,375,434 A	12/1994	Wertheimer
	D383,697 S *	9/1997	Bulgari D11/35
(75) Inventors: Alan McKeever , Milford, OH (US);	5,680,776 A	10/1997	Shenhav
Tina Yelton , Middletown, OH (US);	5,722,261 A	3/1998	Lehrer
Mark Fehrenbach , Fairfield, OH (US)	5,755,117 A	5/1998	Shenhav
	D399,778 S *	10/1998	Bulgari D11/26
(73) Assignee: Yelton's Fine Jewelry , West Chester,	5,836,176 A	11/1998	Lichtenstein
OH (US)	5,996,374 A	12/1999	Bardisbanyan
	6,053,009 A	4/2000	Broggian
(**) Term: 14 Years	6,318,122 B1	11/2001	Burgard
	6,381,985 B1	5/2002	Burgard
(21) Appl. No.: 29/283,015	6,412,304 B1	7/2002	Adelman
	D471,836 S *	3/2003	Chanaratsopon et al. D11/27
(22) Filed: Aug. 3, 2007	6,601,408 B2	8/2003	Burgard
	D523,371 S *	6/2006	Bulgari D11/26

(51) **LOC (8) Cl.** **11-01**
 (52) **U.S. Cl.** **D11/26**
 (58) **Field of Classification Search** D11/3,
 D11/26-39, 91-92; 63/15, 15.1-15.4, 15.45,
 63/15.5, 15.6, 15.65, 15.7, 26-27
 See application file for complete search history.

* cited by examiner

Primary Examiner—Charles A. Rademaker
Assistant Examiner—Melanie Levy
 (74) *Attorney, Agent, or Firm*—Greenebaum Doll &
 McDonald PLLC; Glenn D. Bellamy

(56) **References Cited**

U.S. PATENT DOCUMENTS

211,558 A	1/1879	Edwards
685,044 A	10/1901	Huaussmann
732,334 A	6/1903	Bohner
992,212 A	5/1909	Tropin
1,032,025 A	7/1912	Robbins
1,245,201 A	11/1917	Depollier
1,553,198 A	9/1925	Stem
1,710,734 A	4/1929	Johnson
1,728,266 A	9/1929	Fassnacht
1,792,534 A	2/1931	Germain
1,920,875 A	8/1933	Miskend
2,585,183 A	2/1952	Stern
4,080,803 A	3/1978	Suzuki
4,259,850 A	4/1981	Lalieu
4,517,817 A	5/1985	Levin
4,726,200 A	2/1988	Carter
4,879,882 A	11/1989	Johnson
4,977,757 A	12/1990	Mesica
5,228,317 A	7/1993	Hendricks
5,353,608 A	10/1994	Berkowitz

(57) **CLAIM**

The ornamental design for an interchangeable ornament ring, as shown and described.

DESCRIPTION

FIG. 1 is a front perspective view of an interchangeable ornament ring showing my new design;
 FIG. 2 is a front view thereof; and
 FIG. 3 is a back view thereof; and
 FIG. 4 is a right side view thereof; and
 FIG. 5 is an left side view thereof; and
 FIG. 6 is a top view thereof; and
 FIG. 7 is a bottom view thereof; and,
 FIG. 8 is another front perspective view thereof.

The broken lines are for illustrative purposes only and form no part of the claimed design.

1 Claim, 5 Drawing Sheets

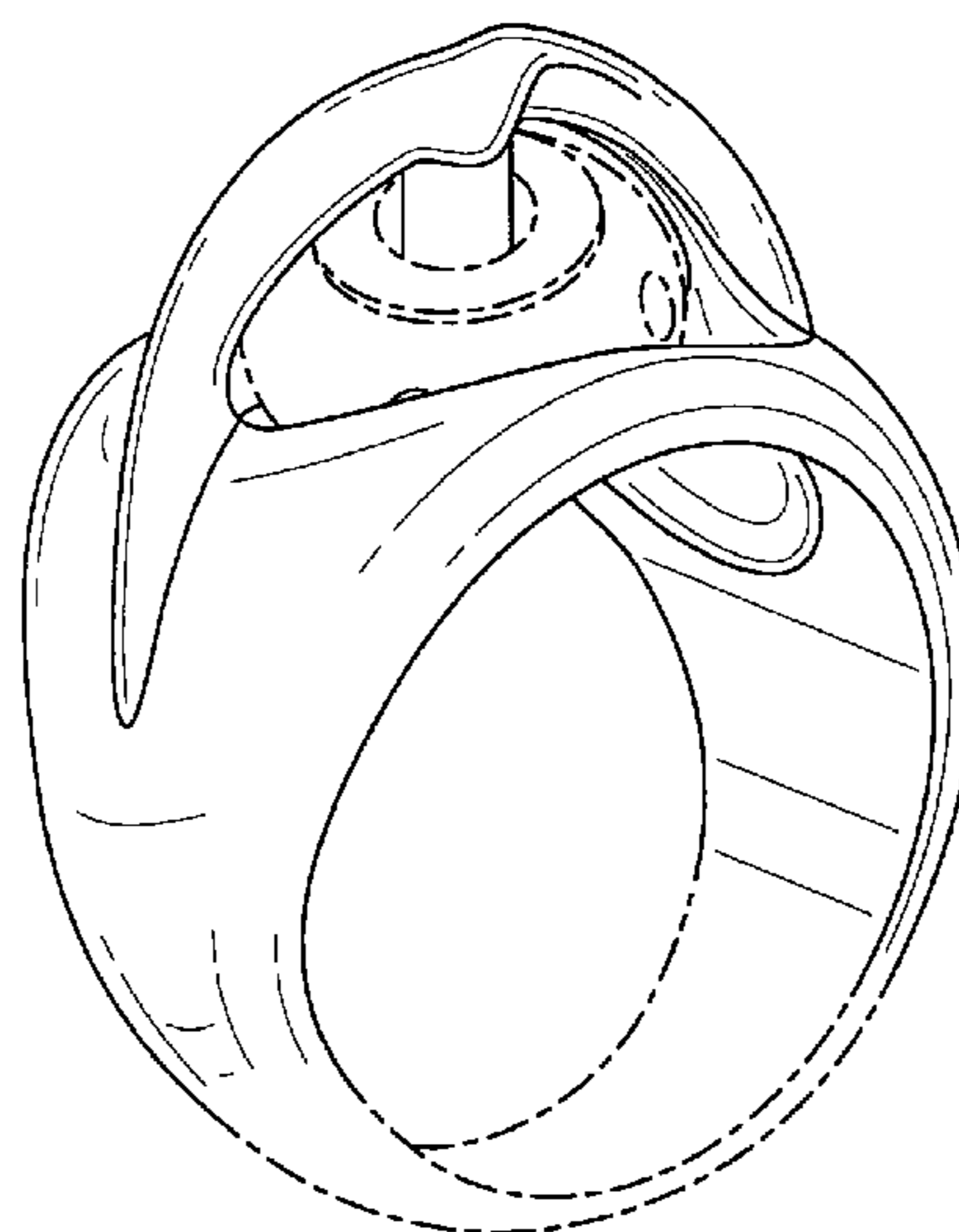

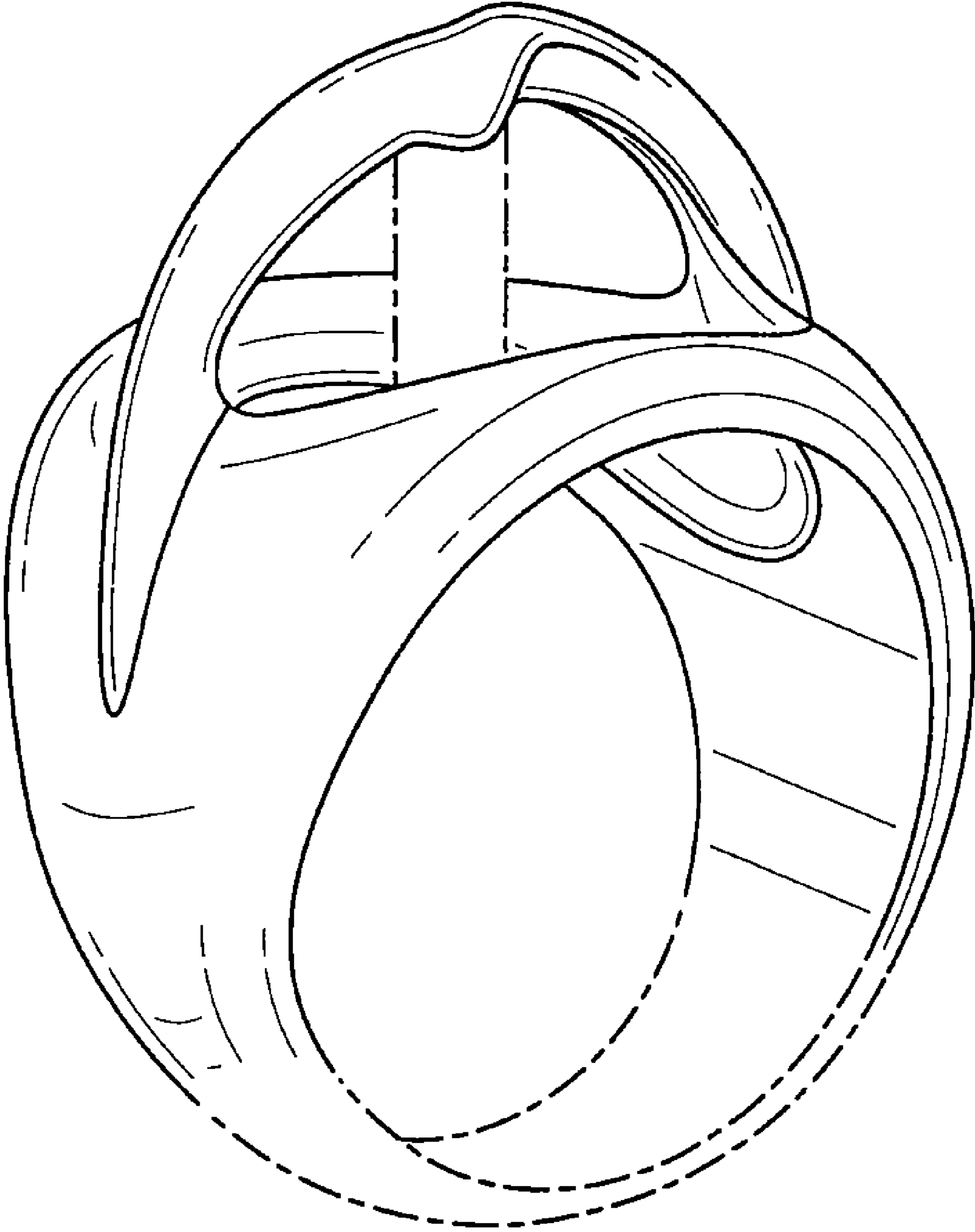

FIG. 1

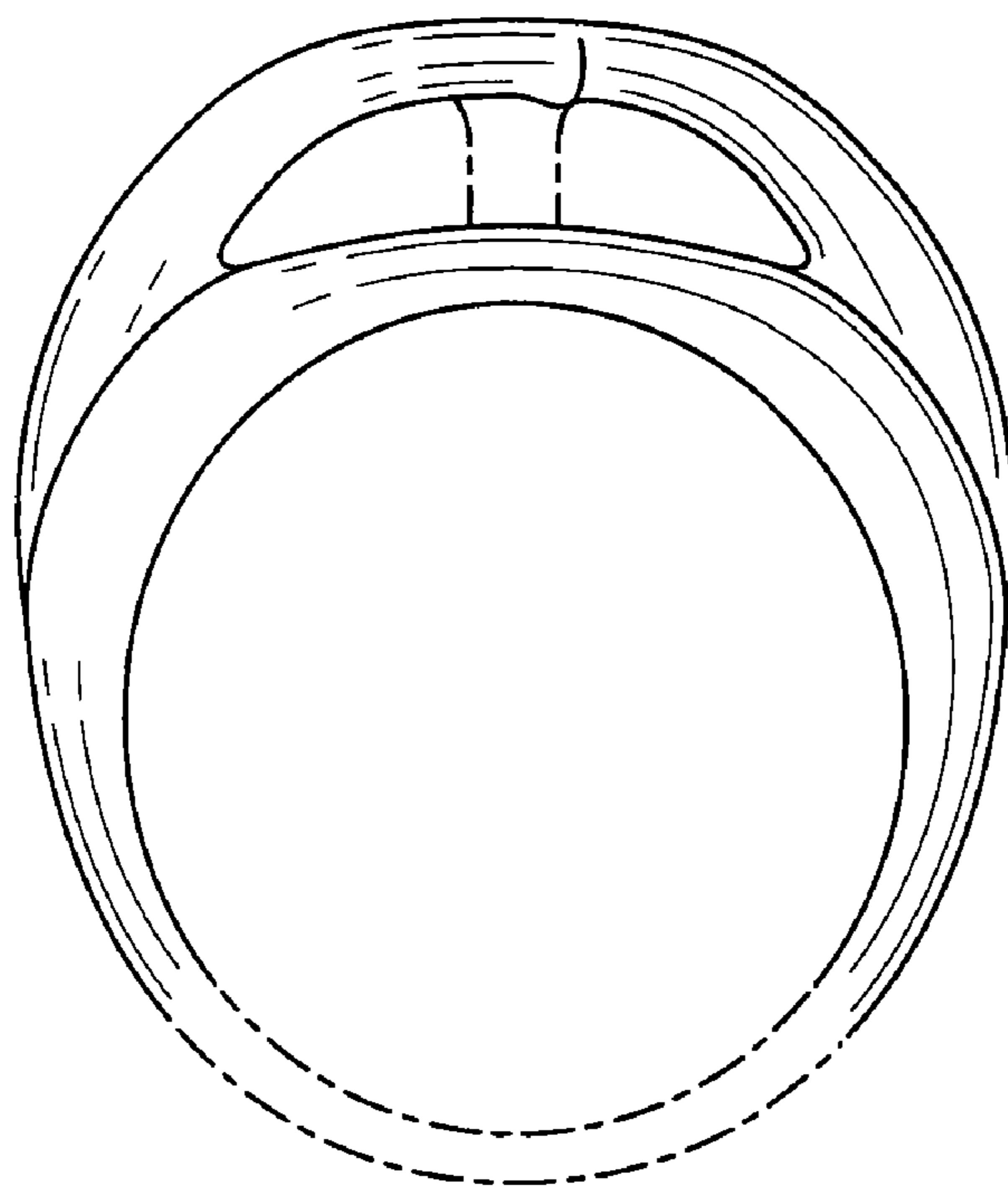

FIG. 2

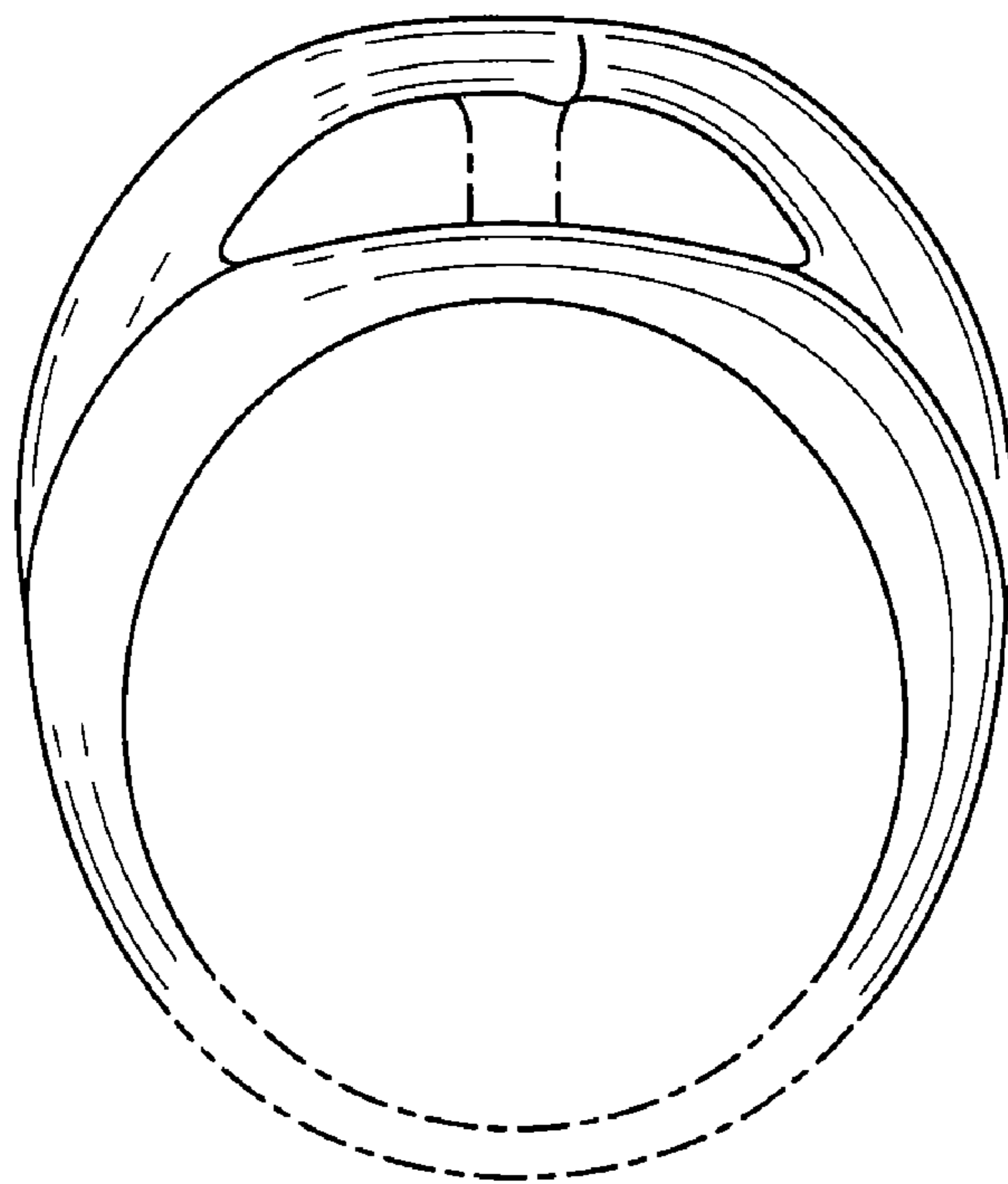

FIG. 3

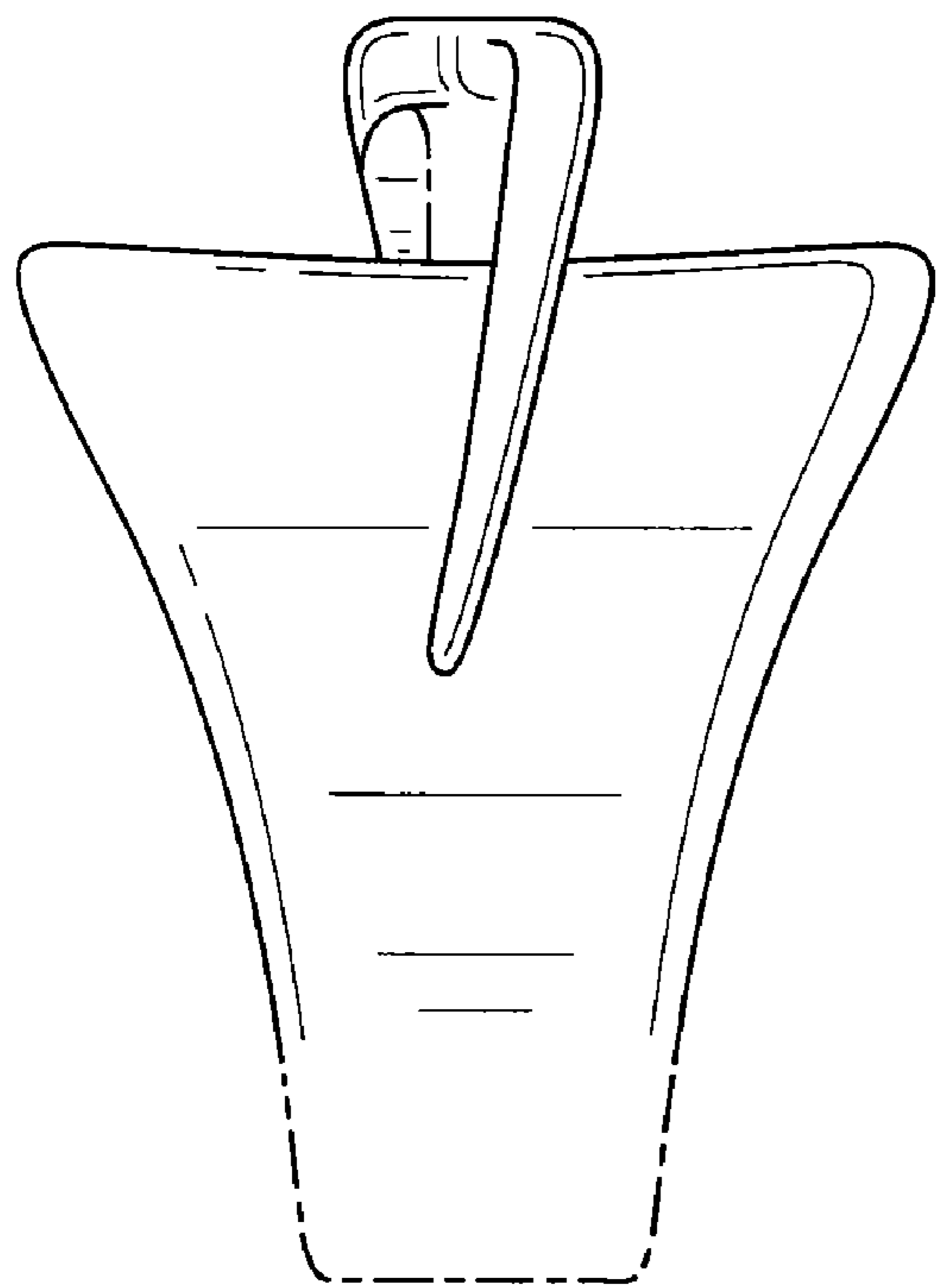

FIG. 4

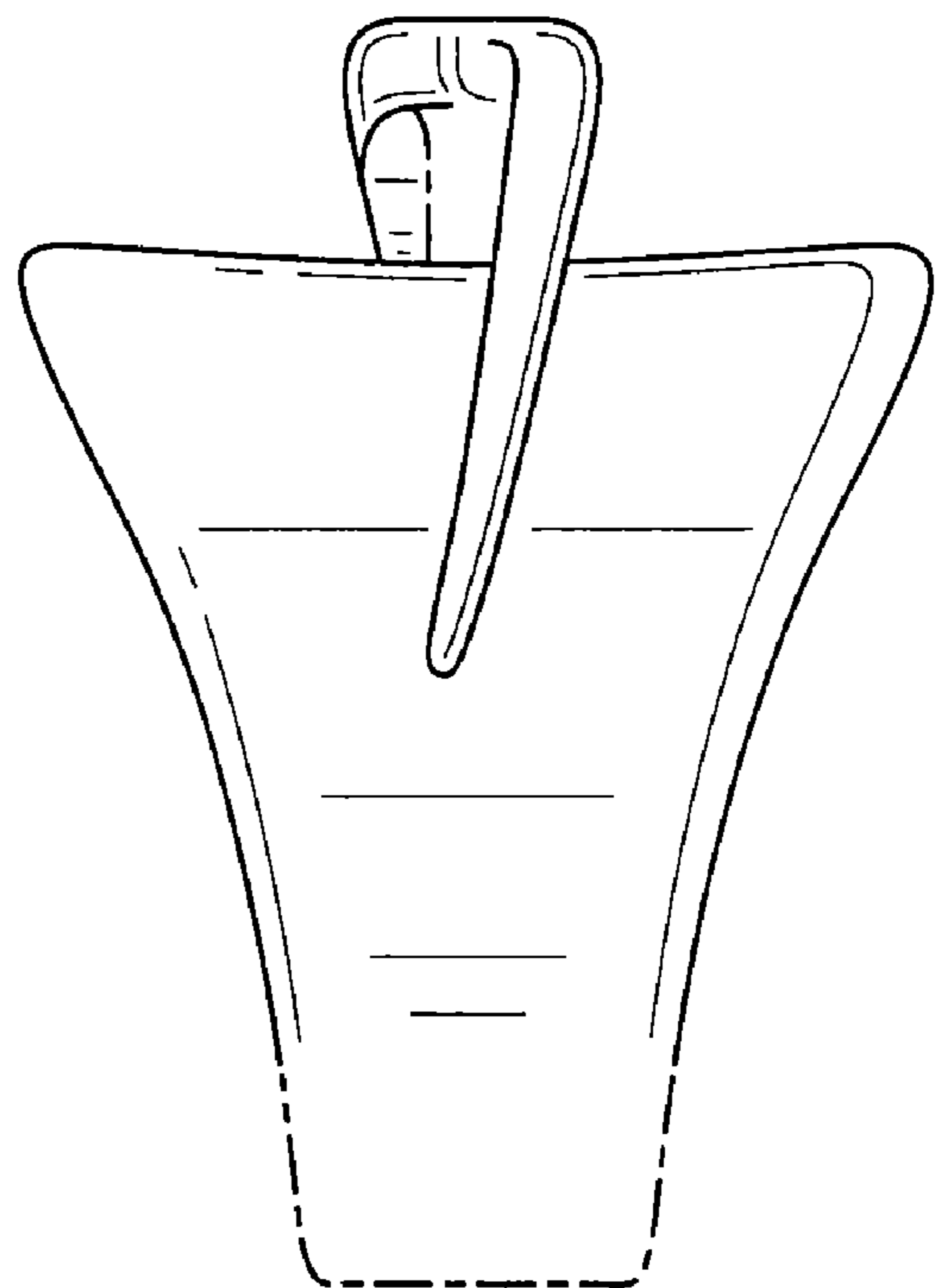

FIG. 5

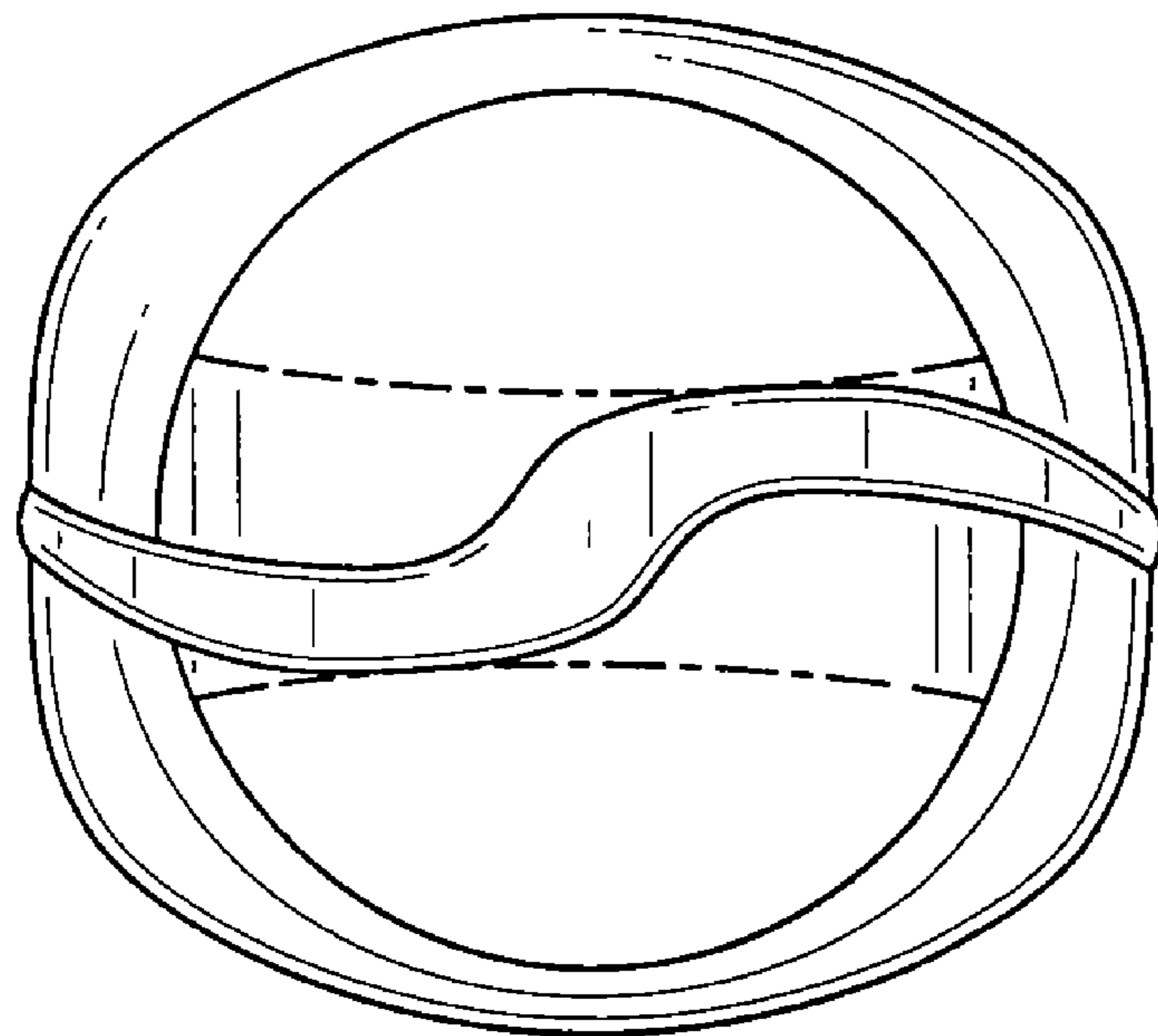

FIG. 6

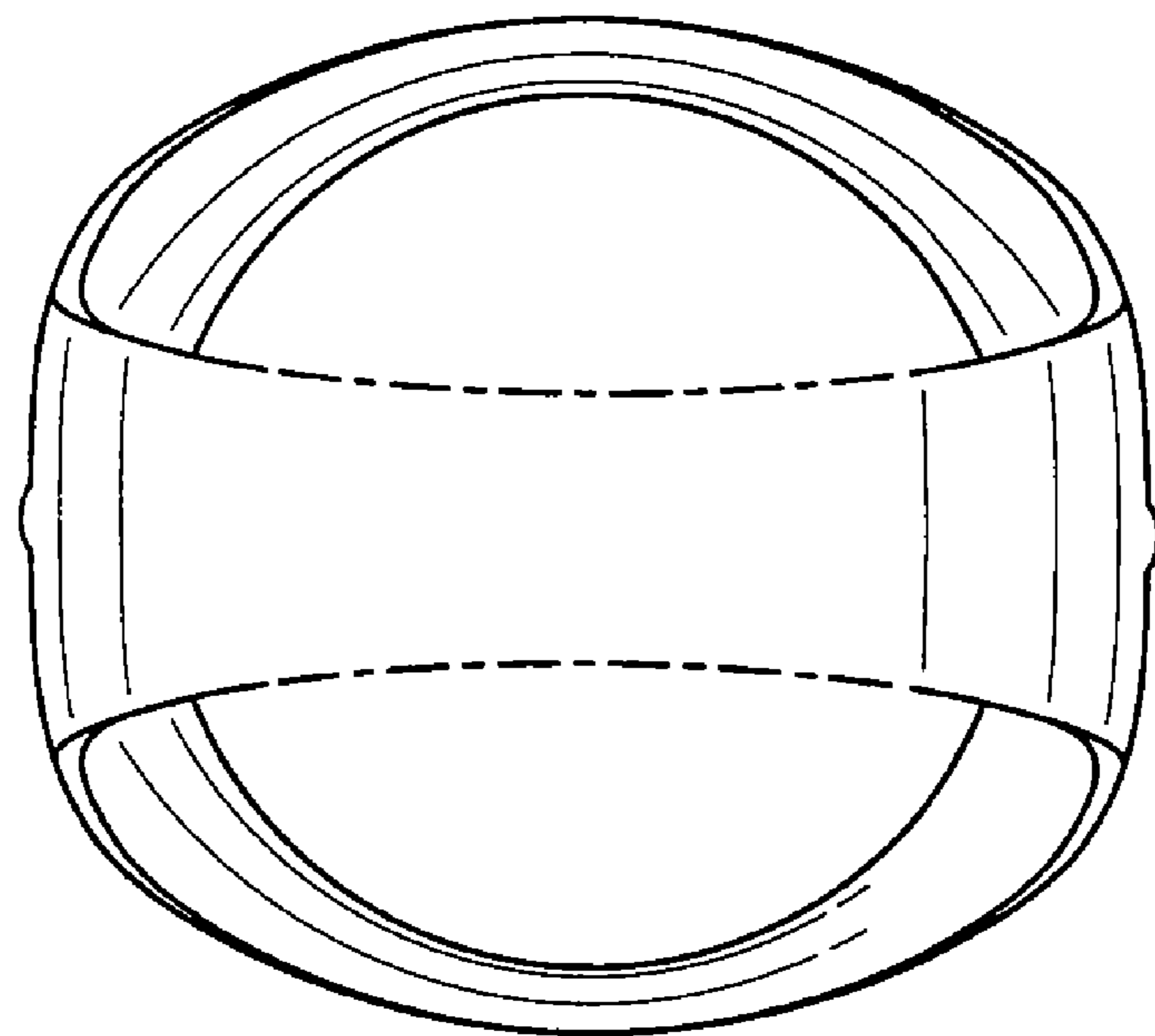

FIG. 7

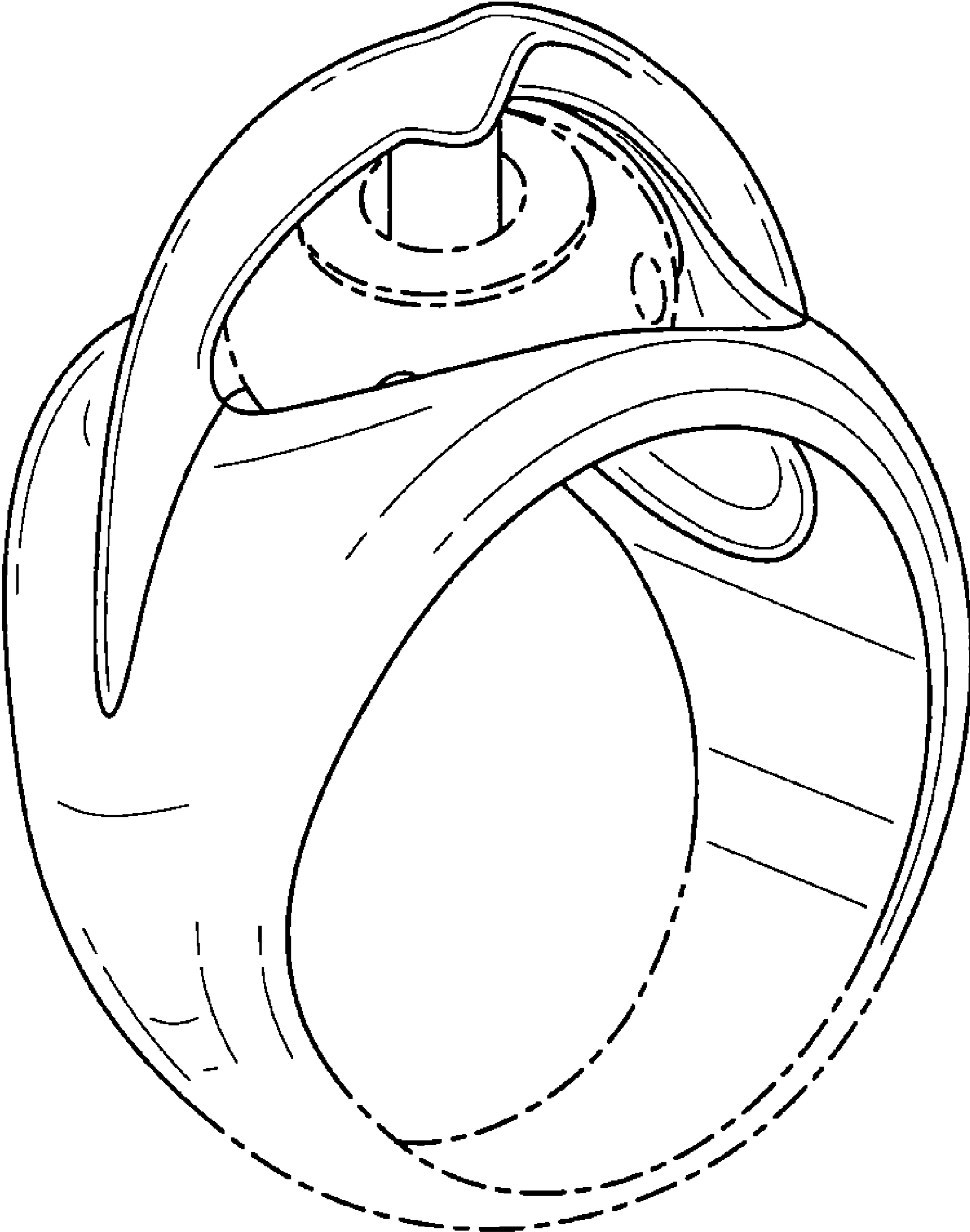

FIG. 8