

US00D563792S

(12) **United States Design Patent**  
**Steiger et al.**

(10) **Patent No.: US D563,792 S**  
(45) **Date of Patent: \*\* Mar. 11, 2008**

(54) **BOTTLE**

**DESCRIPTION**

(75) Inventors: **John Steiger**, Glenview, IL (US);  
**Machelle Stockwell**, Cary, IL (US);  
**Sheldon Yourist**, York, PA (US)  
(73) Assignee: **Tropicana Products, Inc.**, Bradenton,  
FL (US)  
(\*\*) Term: **14 Years**  
(21) Appl. No.: **29/267,609**  
(22) Filed: **Oct. 17, 2006**  
(51) **LOC (8) Cl. .... 09-01**  
(52) **U.S. Cl. .... D9/531**  
(58) **Field of Classification Search .... D9/516,**  
D9/523, 525, 528, 529, 531, 540, 550, 563,  
D9/575; 215/14, 200, 217, 218, 223, 241,  
215/379, 383-385, 396, 398; 220/200, 260,  
220/890; 222/92, 109, 210, 212, 205  
See application file for complete search history.

(56) **References Cited**

**U.S. PATENT DOCUMENTS**

D304,423 S *	11/1989	Beaver .....	D9/528
D314,140 S *	1/1991	Kornick et al. ....	D9/528
D394,811 S *	6/1998	Jagielski et al. ....	D9/528
D439,520 S *	3/2001	Walther et al. ....	D9/528
D524,660 S *	7/2006	Floyd et al. ....	D9/550
D549,580 S *	8/2007	Bates et al. ....	D9/528
D550,560 S *	9/2007	Bates et al. ....	D9/528

\* cited by examiner

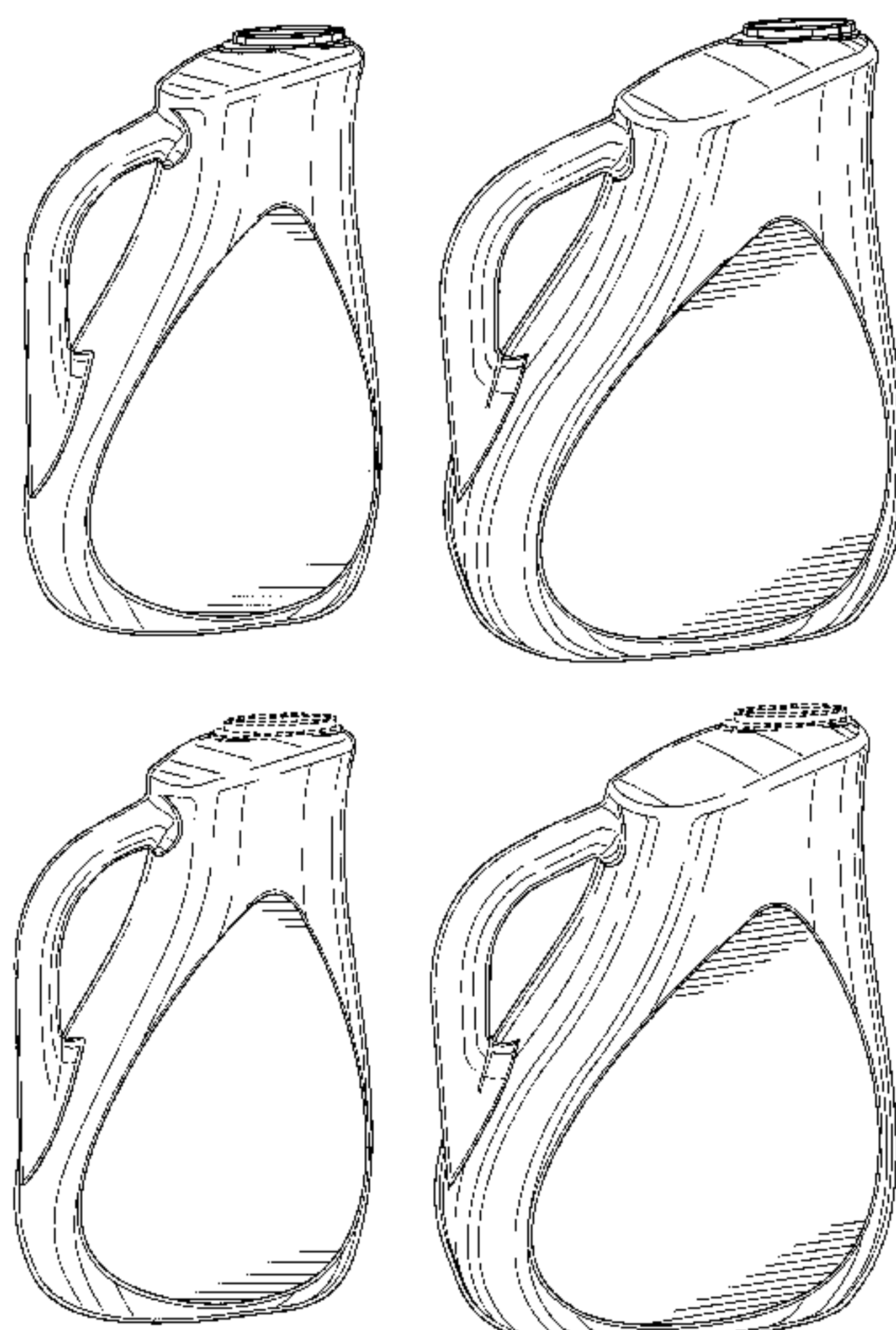
*Primary Examiner*—Stella M. Reid  
*Assistant Examiner*—Shanda C. Hill  
(74) *Attorney, Agent, or Firm*—Banner & Witcoff, Ltd.

(57) **CLAIM**

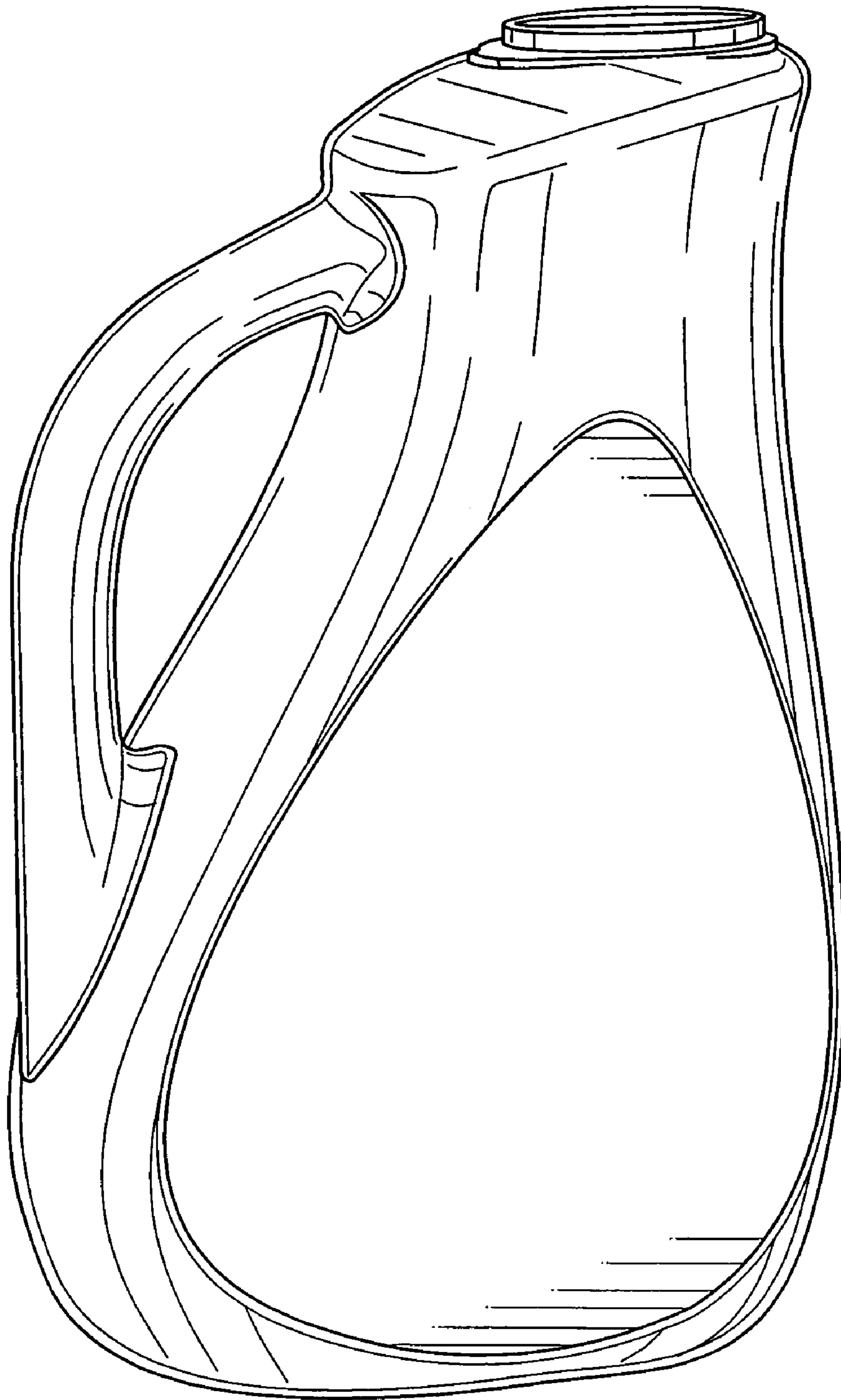
The ornamental design for a bottle, as shown and described.

FIG. 1 is a perspective view of a bottle showing our new design;  
FIG. 2 is a side elevation view thereof;  
FIG. 3 is a back elevation view thereof;  
FIG. 4 is a front elevation view thereof;  
FIG. 5 is a top plan view thereof;  
FIG. 6 is a bottom plan view thereof;  
FIG. 7 is a perspective view of a second embodiment of the bottle;  
FIG. 8 is a side elevation view thereof;  
FIG. 9 is a back elevation view thereof;  
FIG. 10 is a front elevation view thereof;  
FIG. 11 is a top plan view thereof;  
FIG. 12 is a bottom plan view thereof;  
FIG. 13 is a perspective view of a third embodiment of the bottle;  
FIG. 14 is a side elevation view thereof;  
FIG. 15 is a back elevation view thereof;  
FIG. 16 is a front elevation view thereof;  
FIG. 17 is a top plan view thereof;  
FIG. 18 is a bottom plan view thereof;  
FIG. 19 is a perspective view of a fourth embodiment of the bottle;  
FIG. 20 is a side elevation view thereof;  
FIG. 21 is a back elevation view thereof;  
FIG. 22 is a front elevation view thereof;  
FIG. 23 is a top plan view thereof; and,  
FIG. 24 is a bottom plan view thereof.  
The broken lines shown in the drawing disclosure are for illustrative purposes only and form no part of the claimed design.

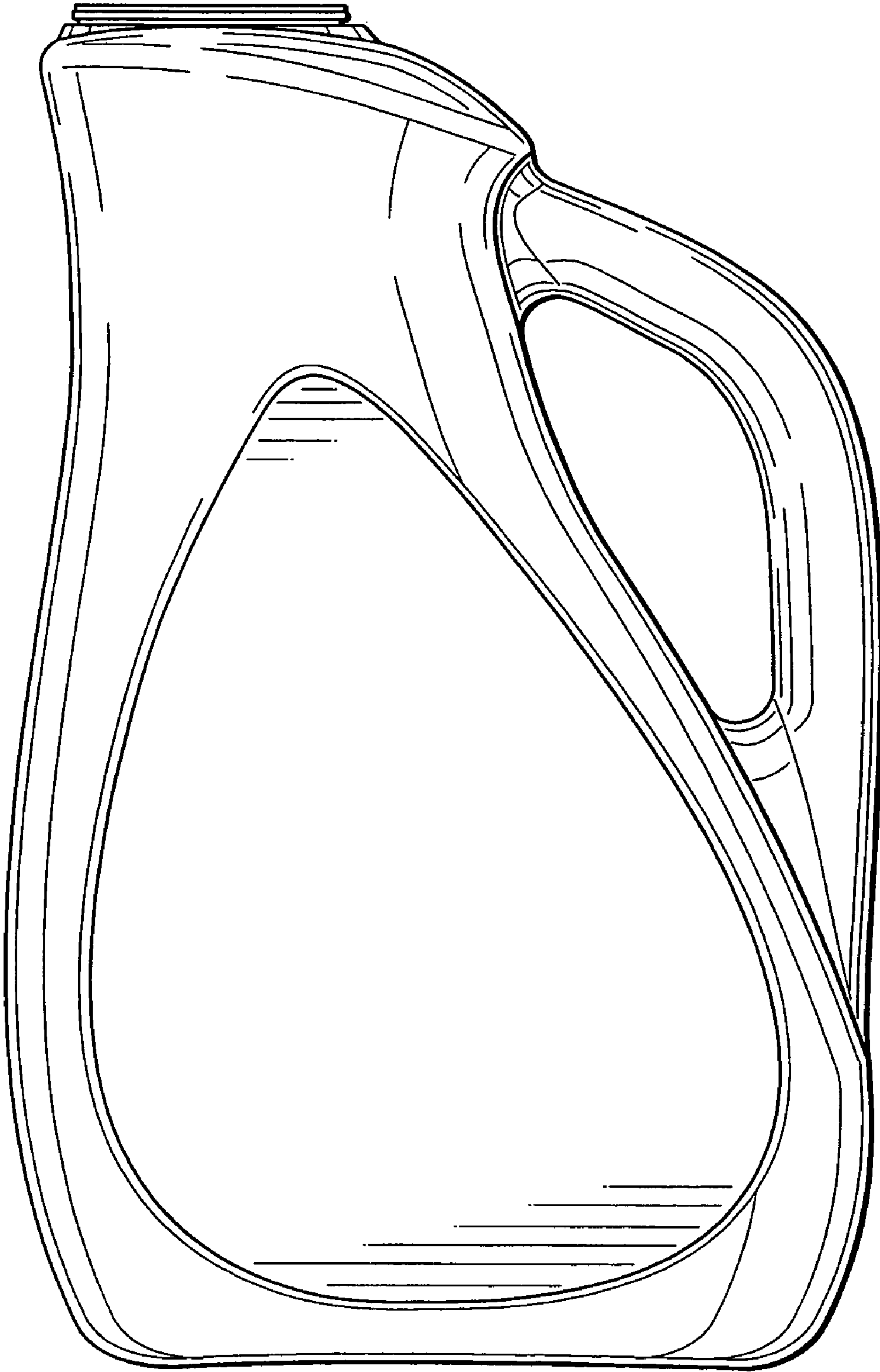
**1 Claim, 20 Drawing Sheets**



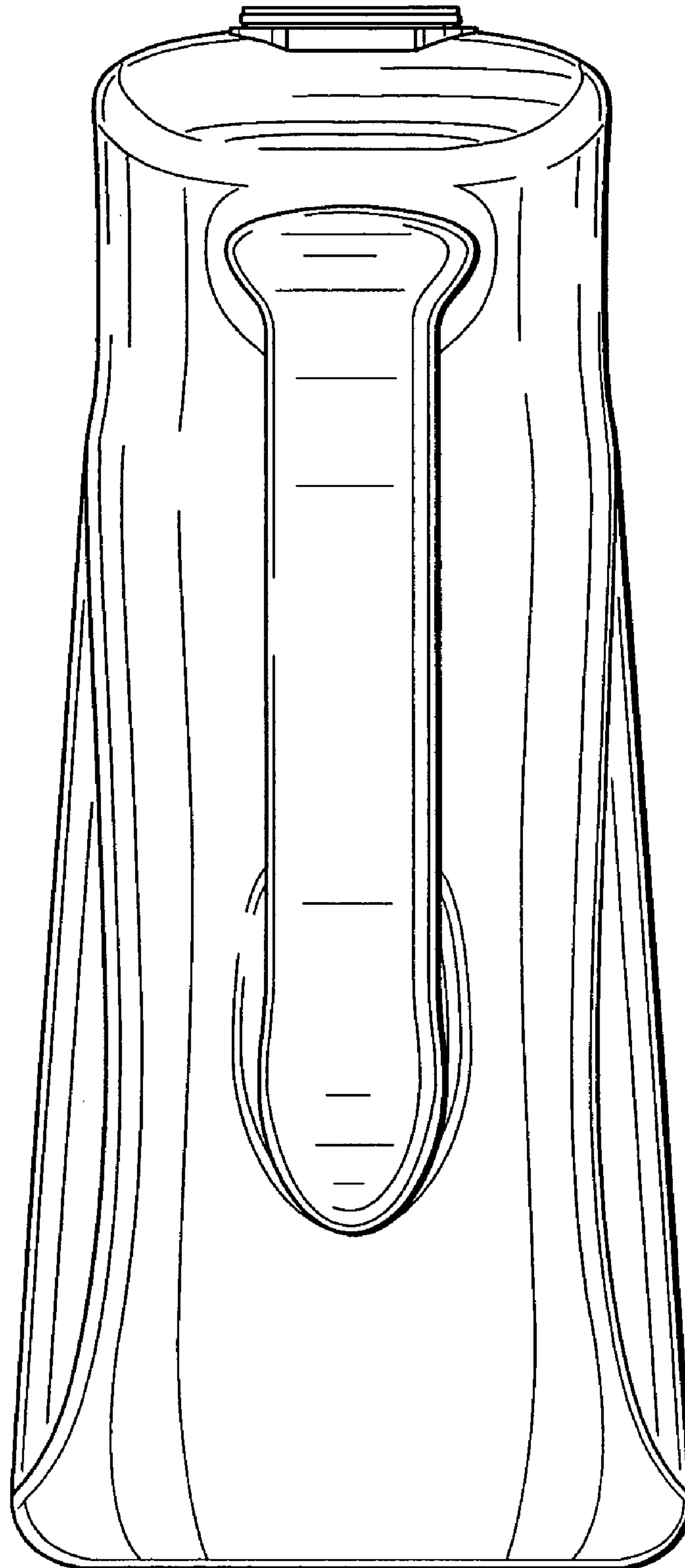
**Fig. 1**



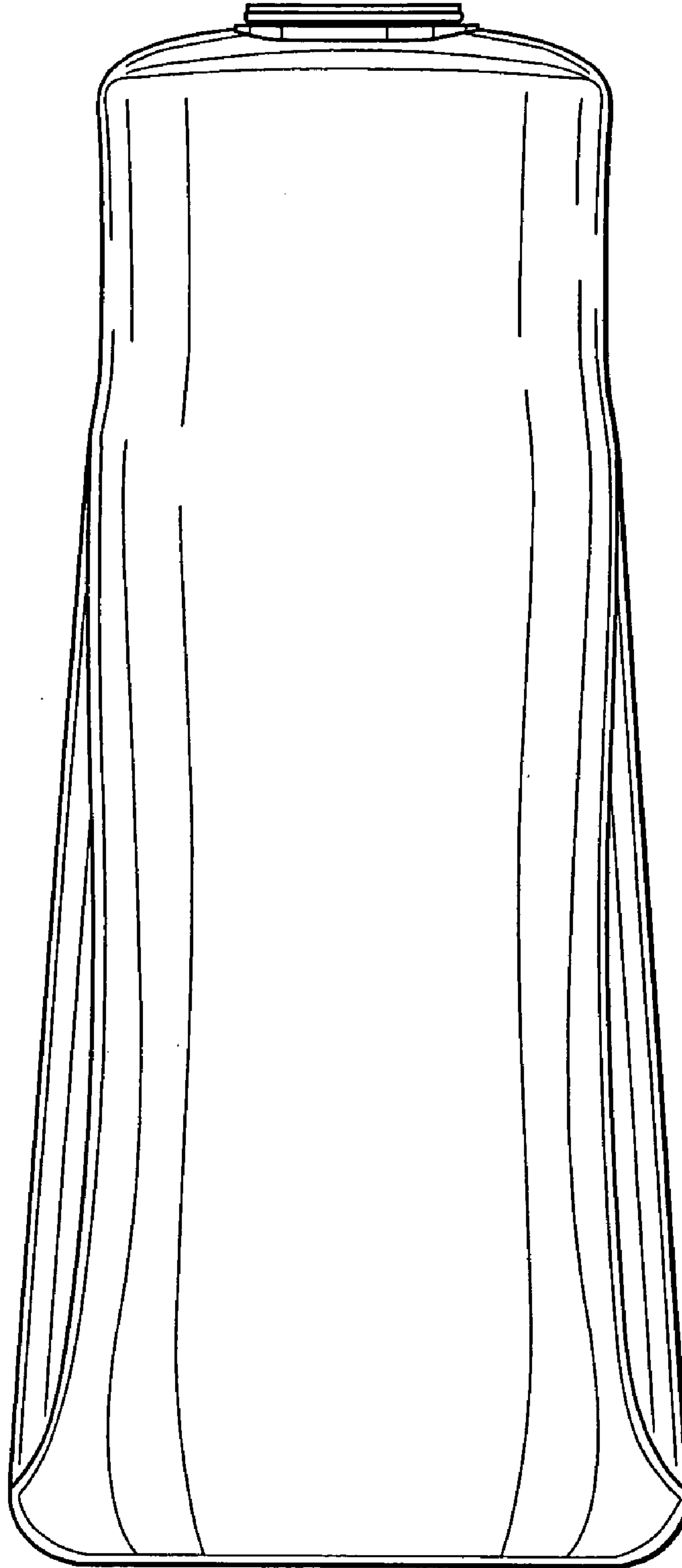
**Fig. 2**



**Fig. 3**

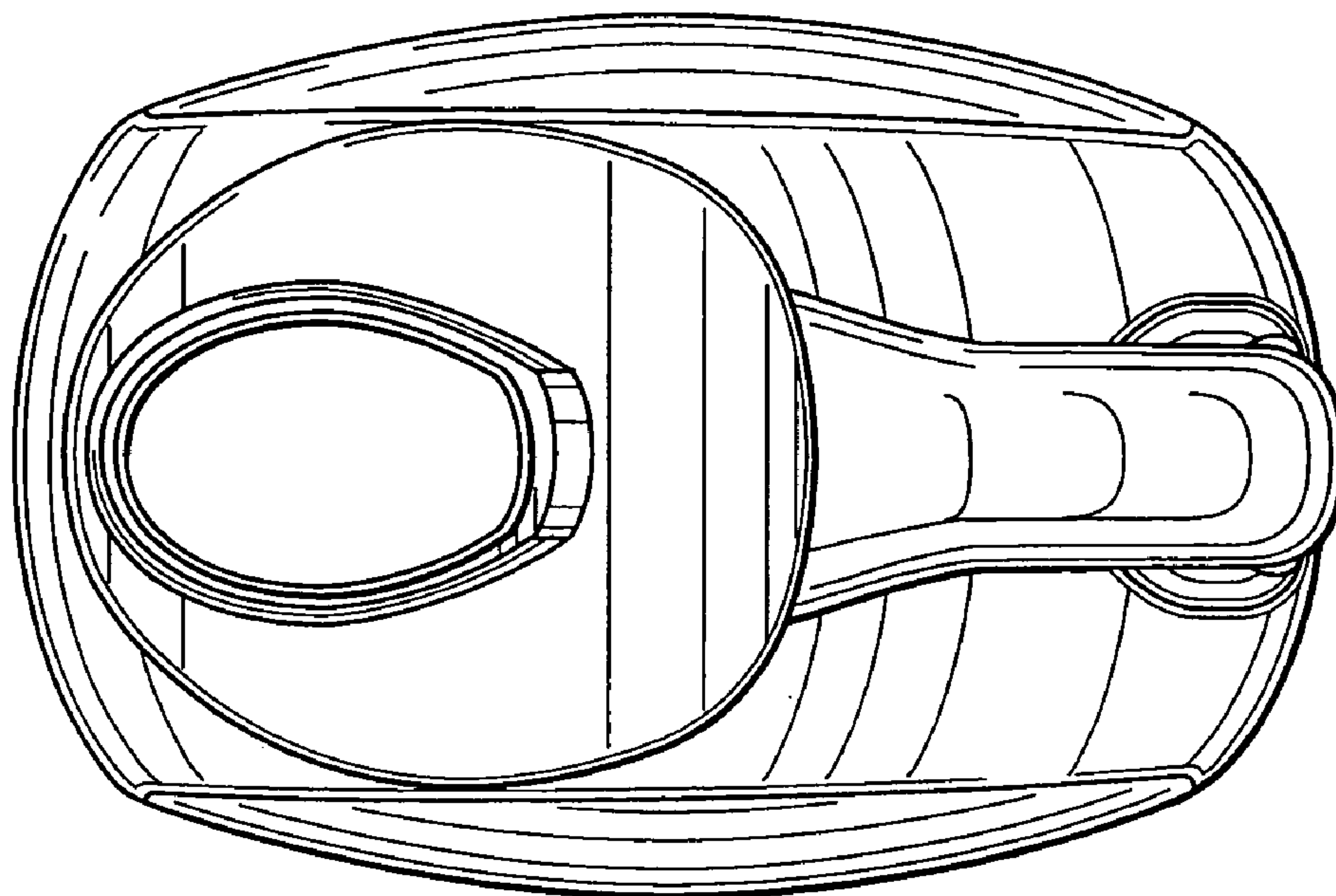


***Fig. 4***

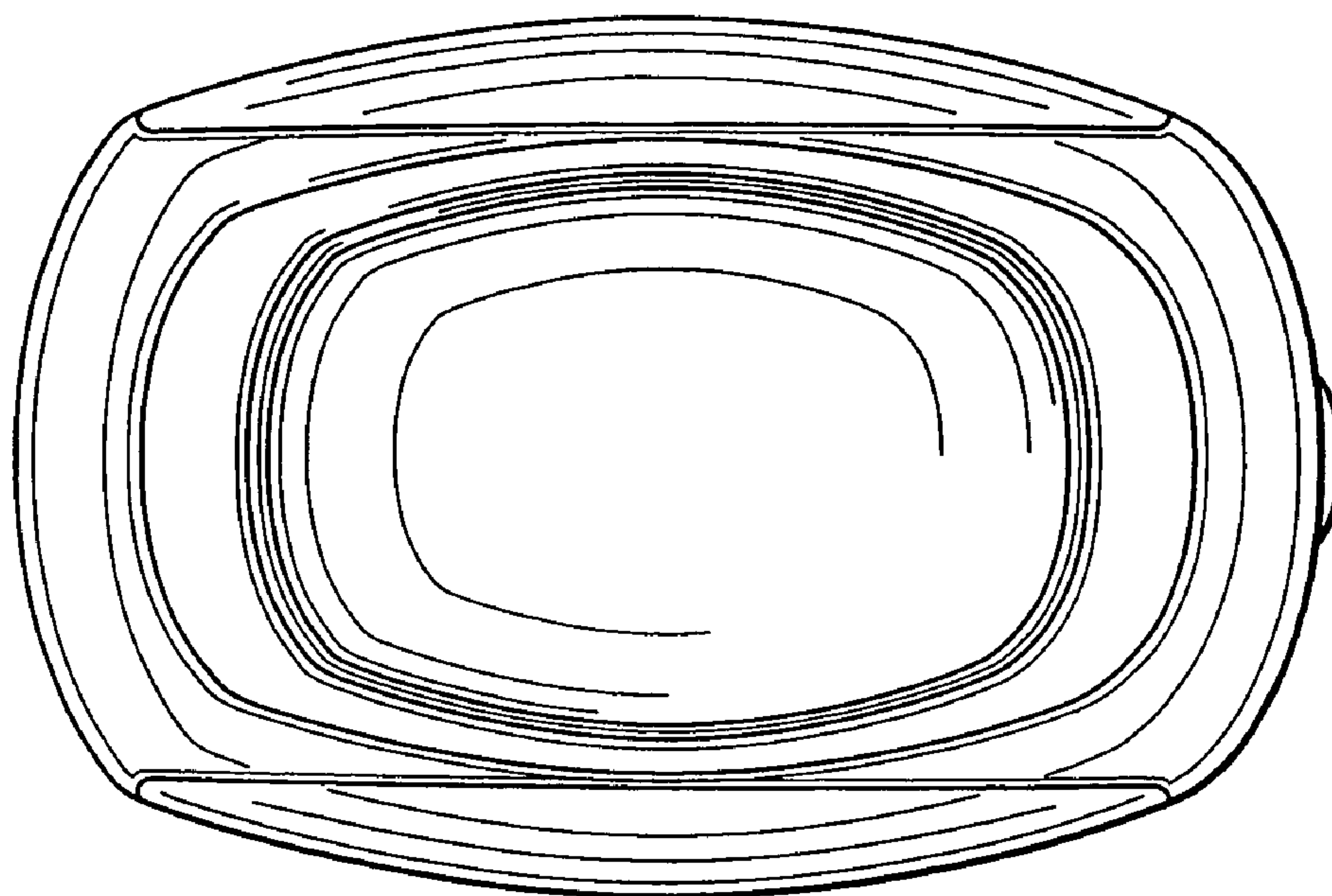




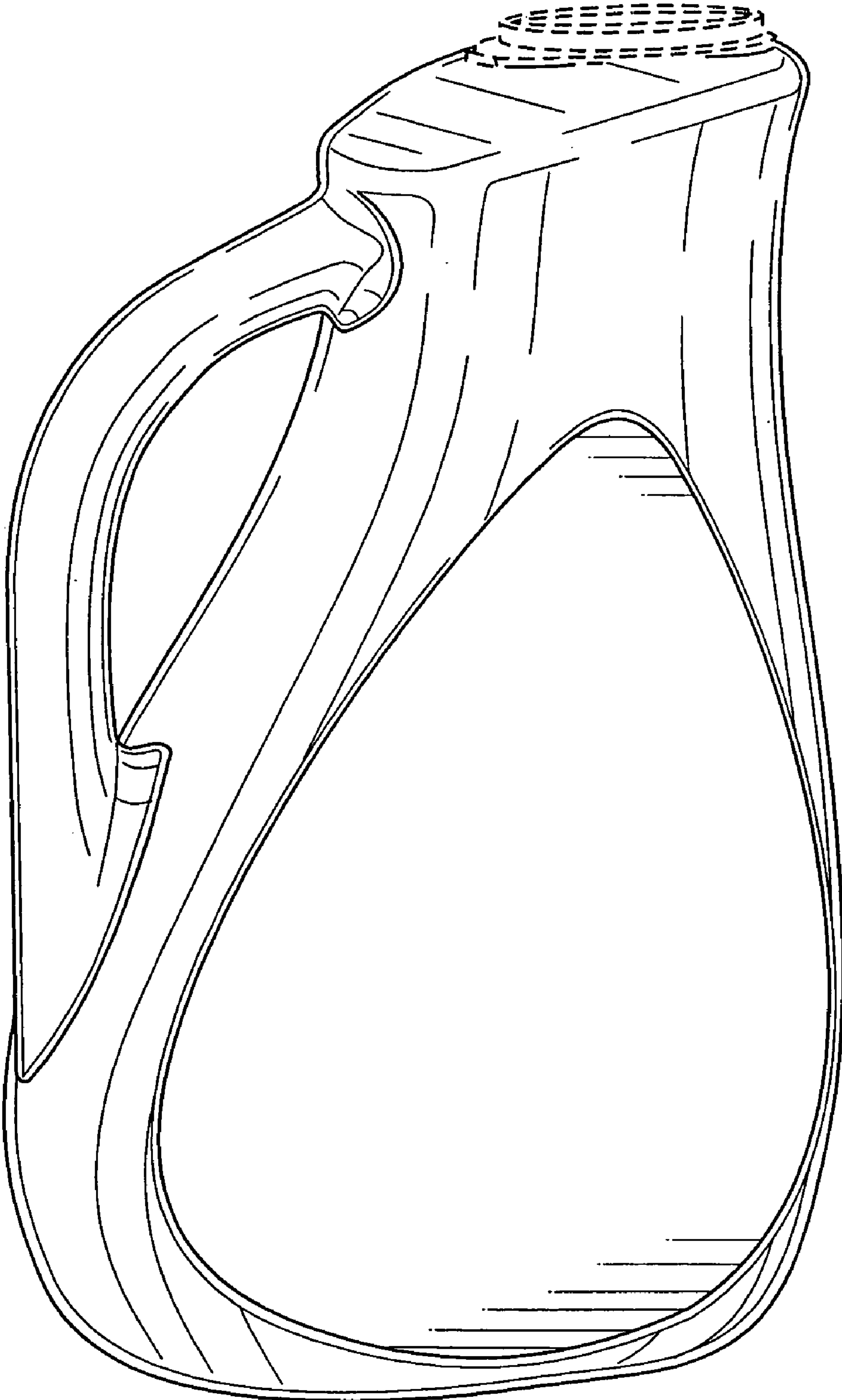
**Fig. 5**



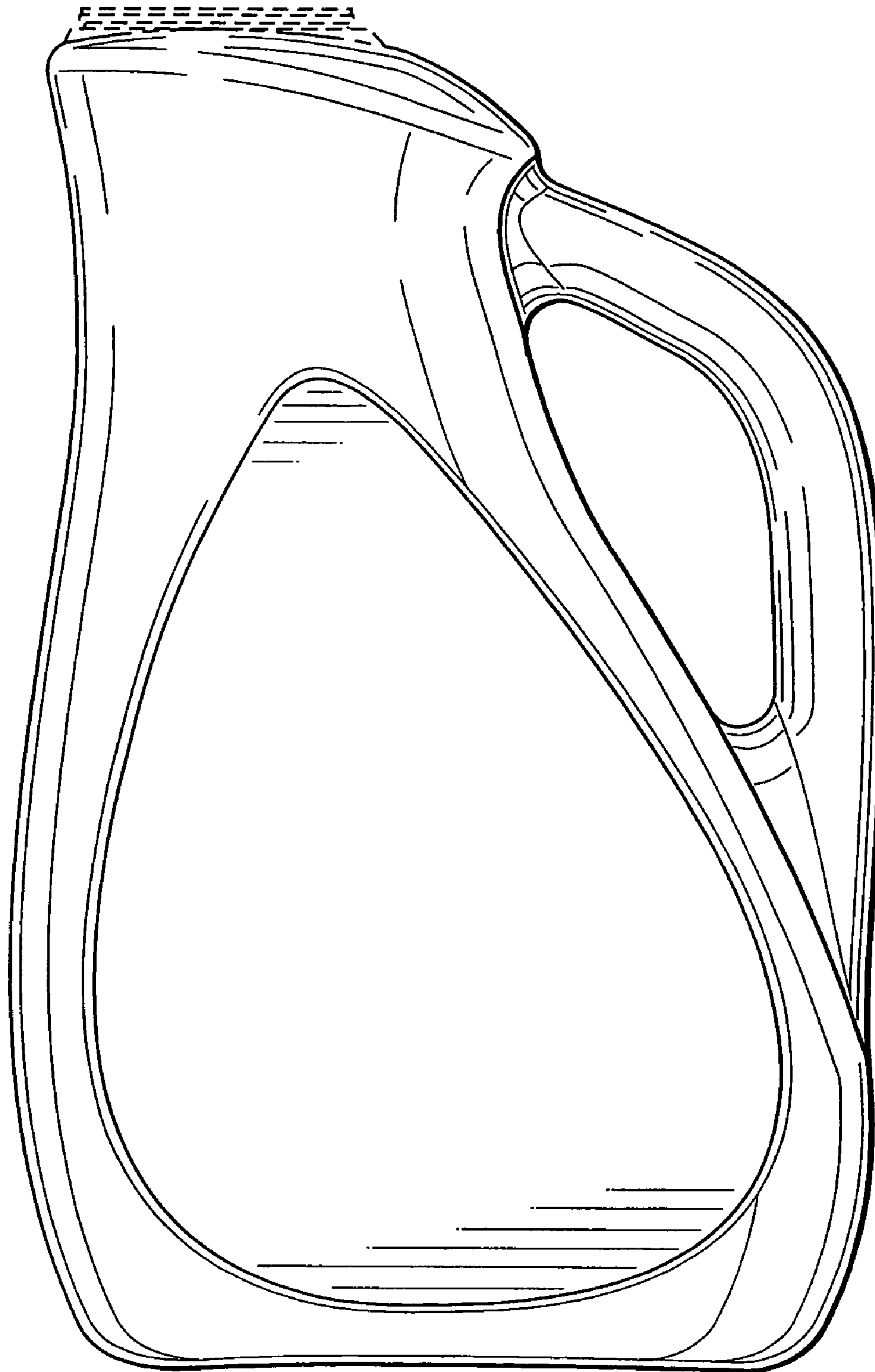
**Fig. 6**



**Fig. 7**

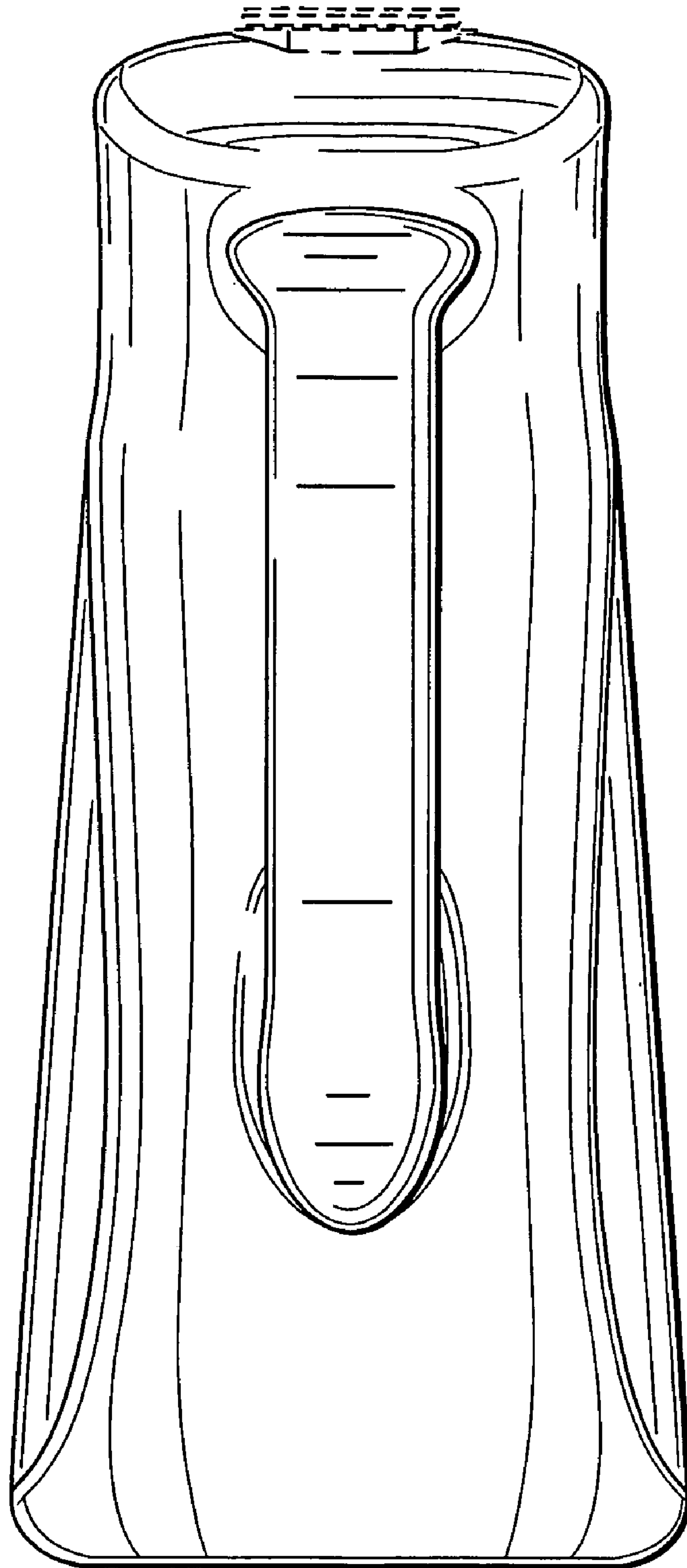


**Fig. 8**

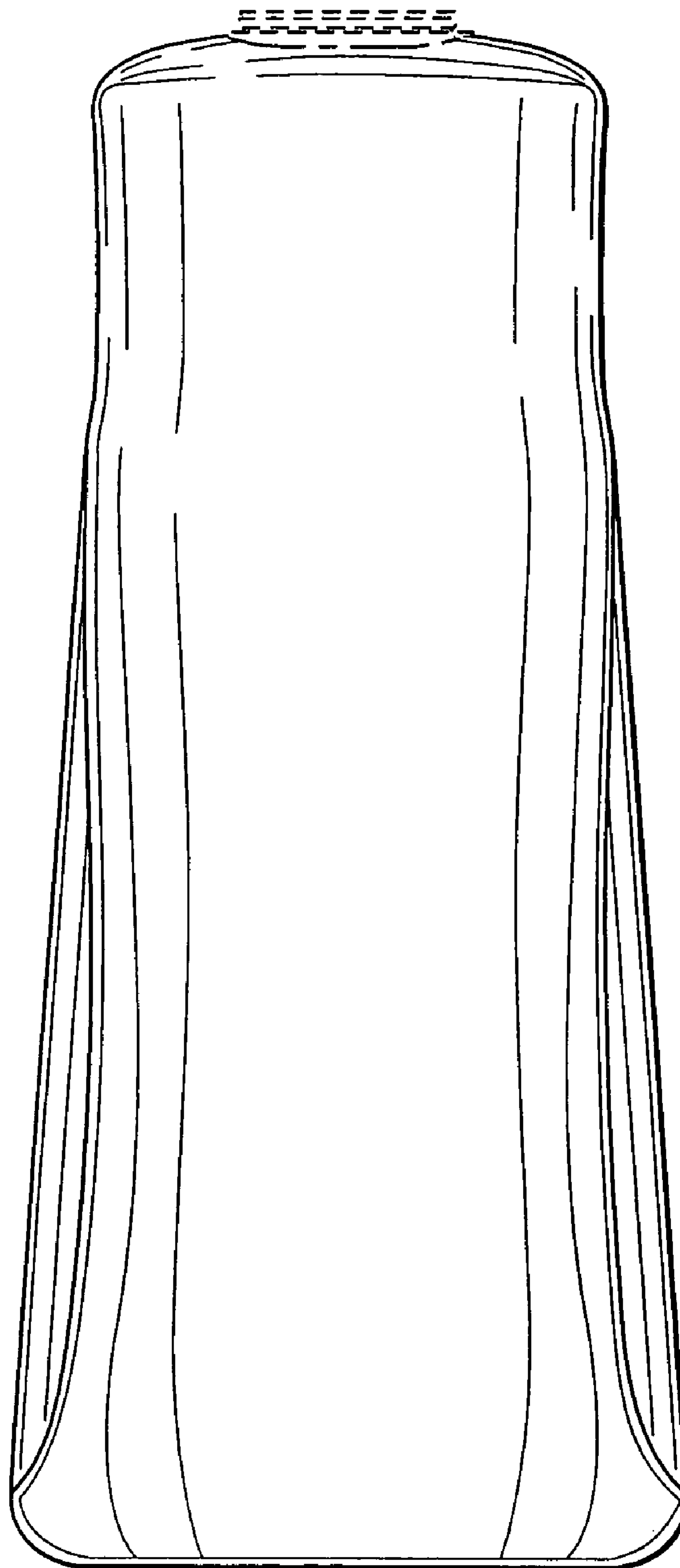




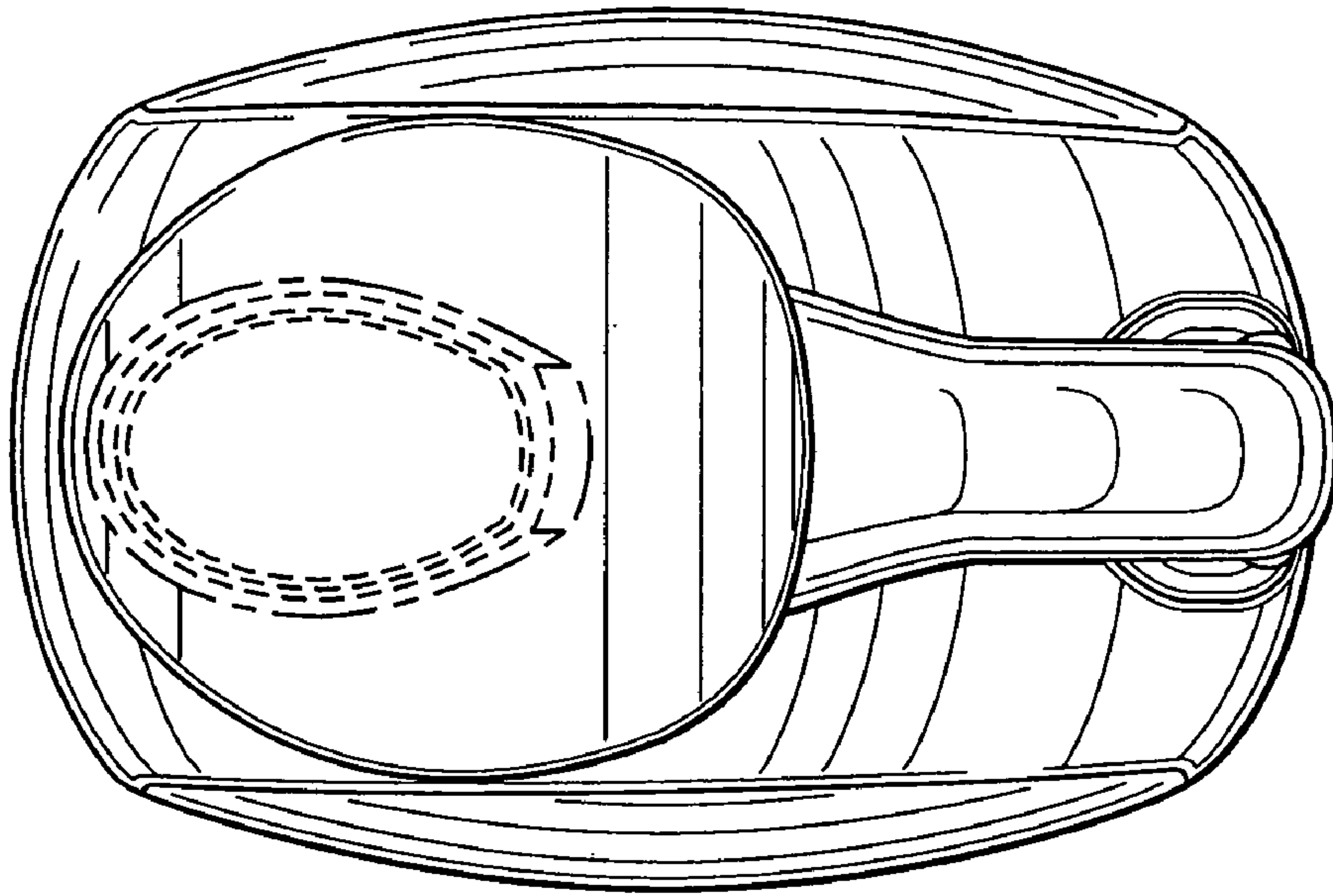
**Fig. 9**



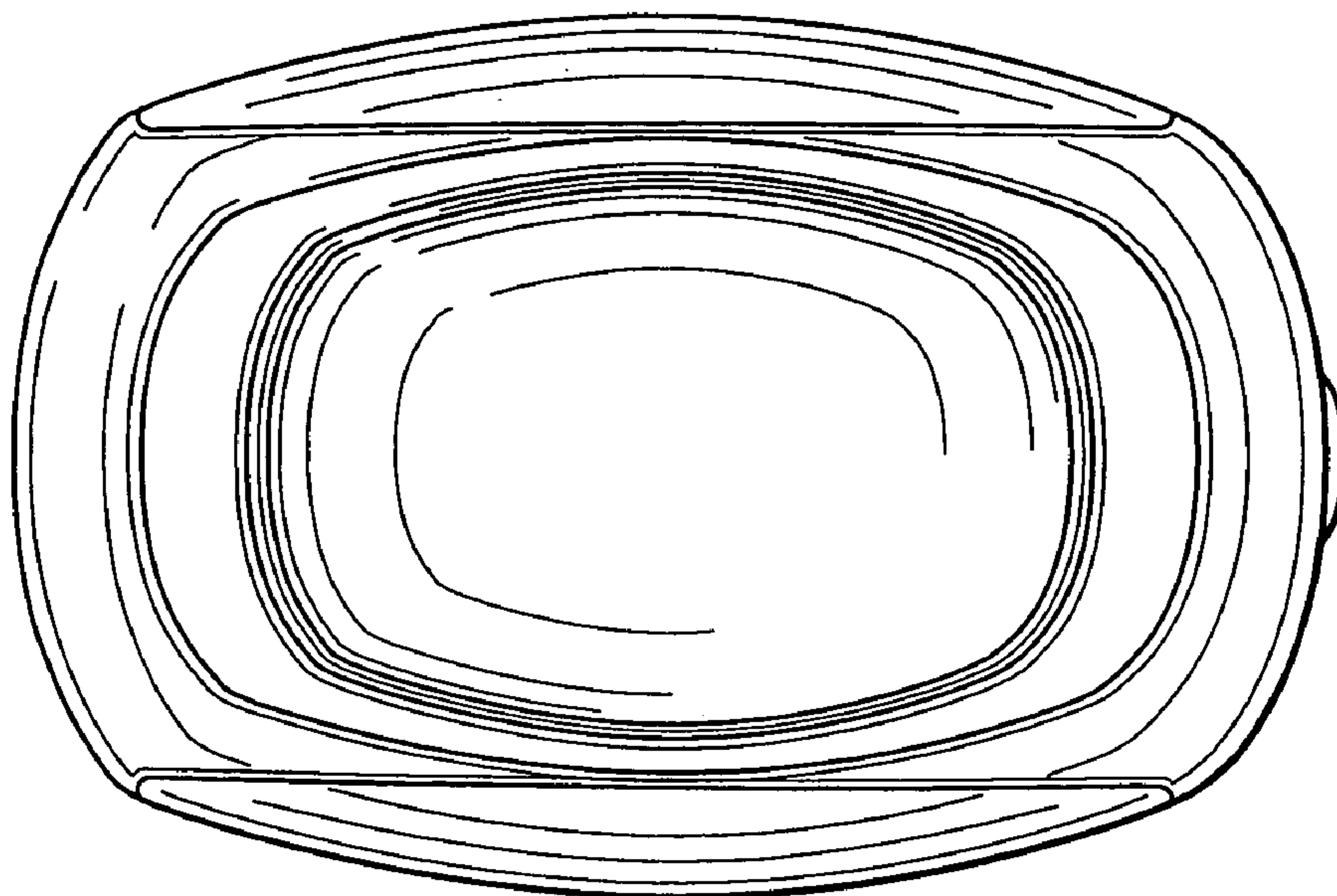
***Fig. 10***



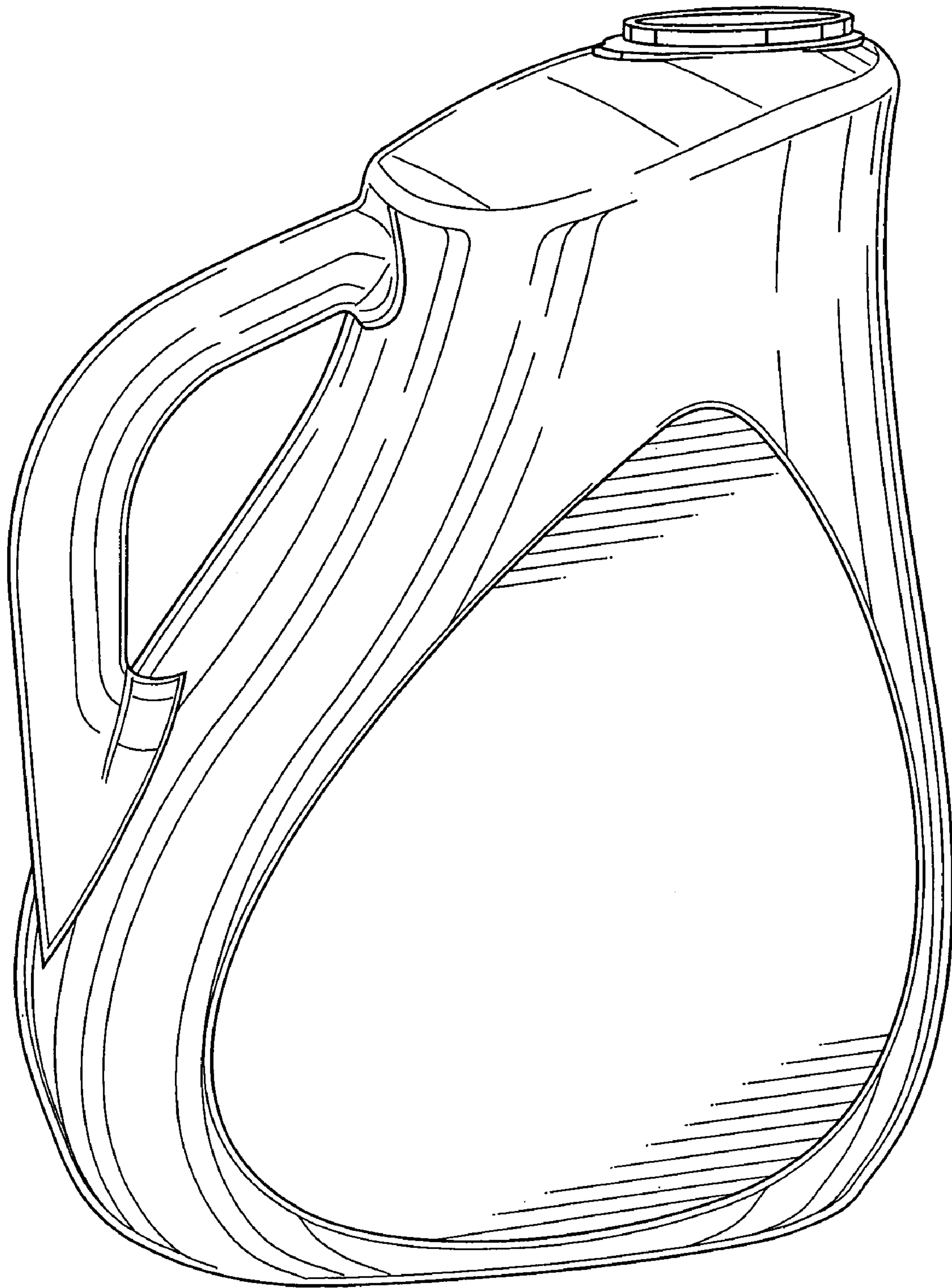
**Fig. 11**



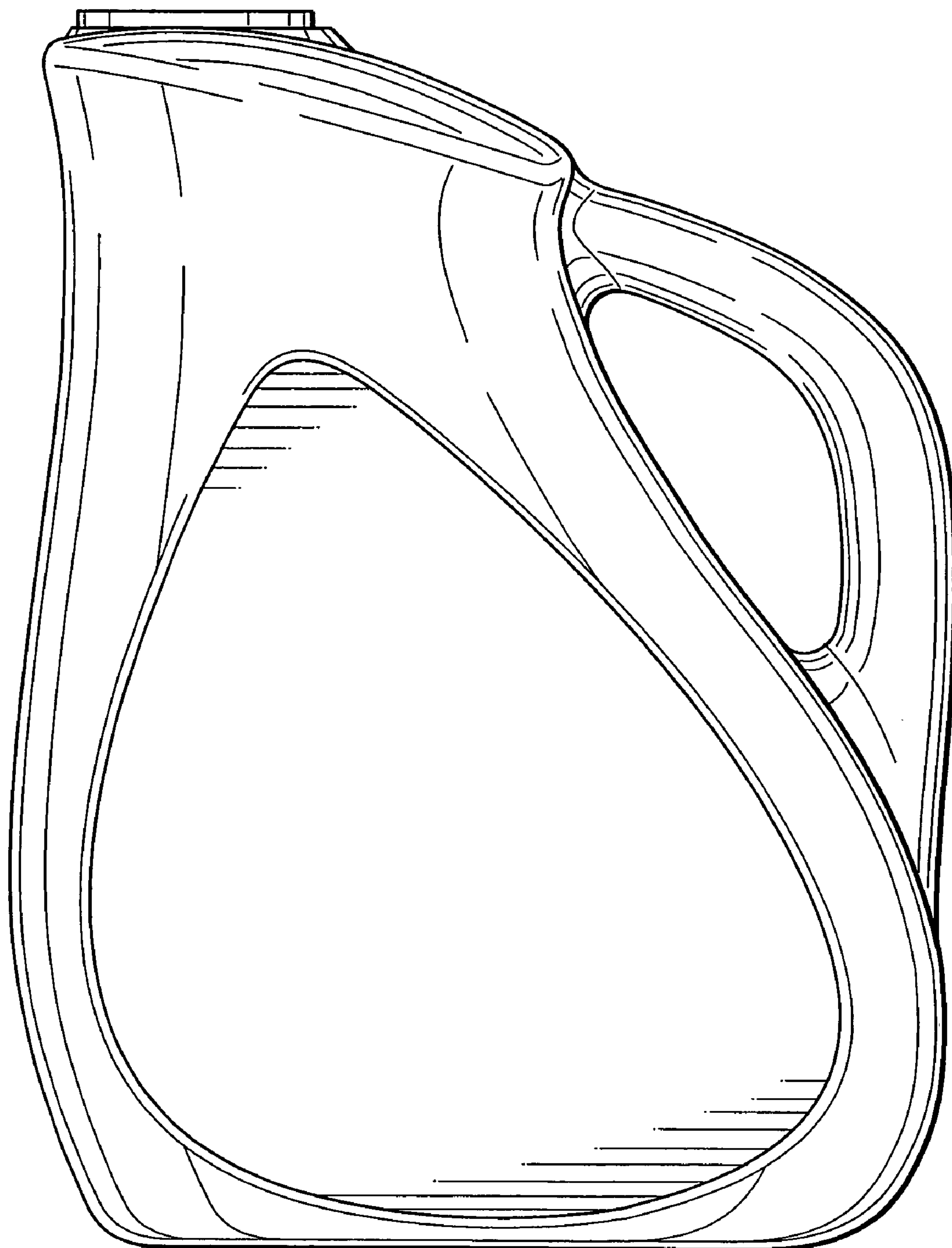
**Fig. 12**



**Fig. 13**

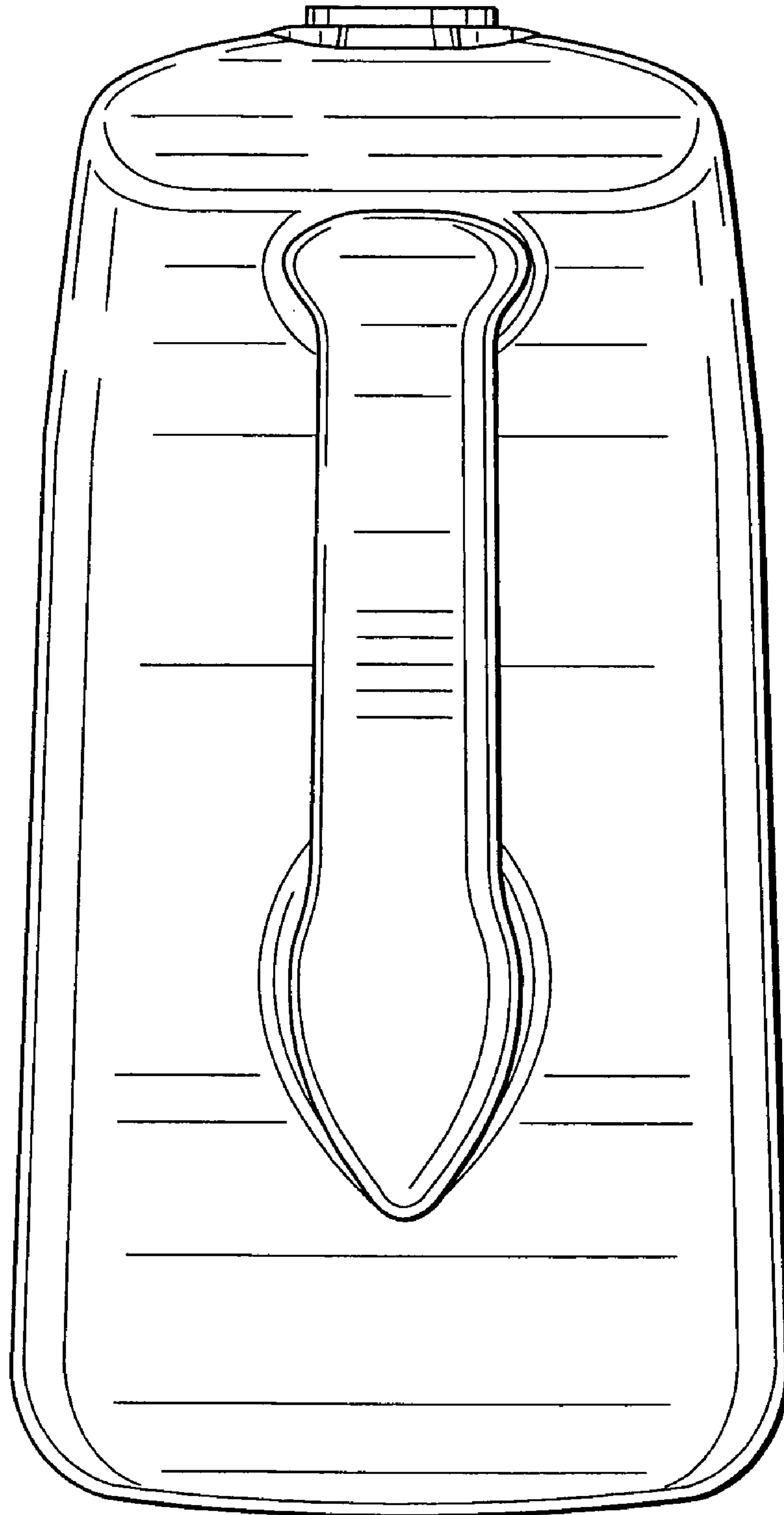


**Fig. 14**

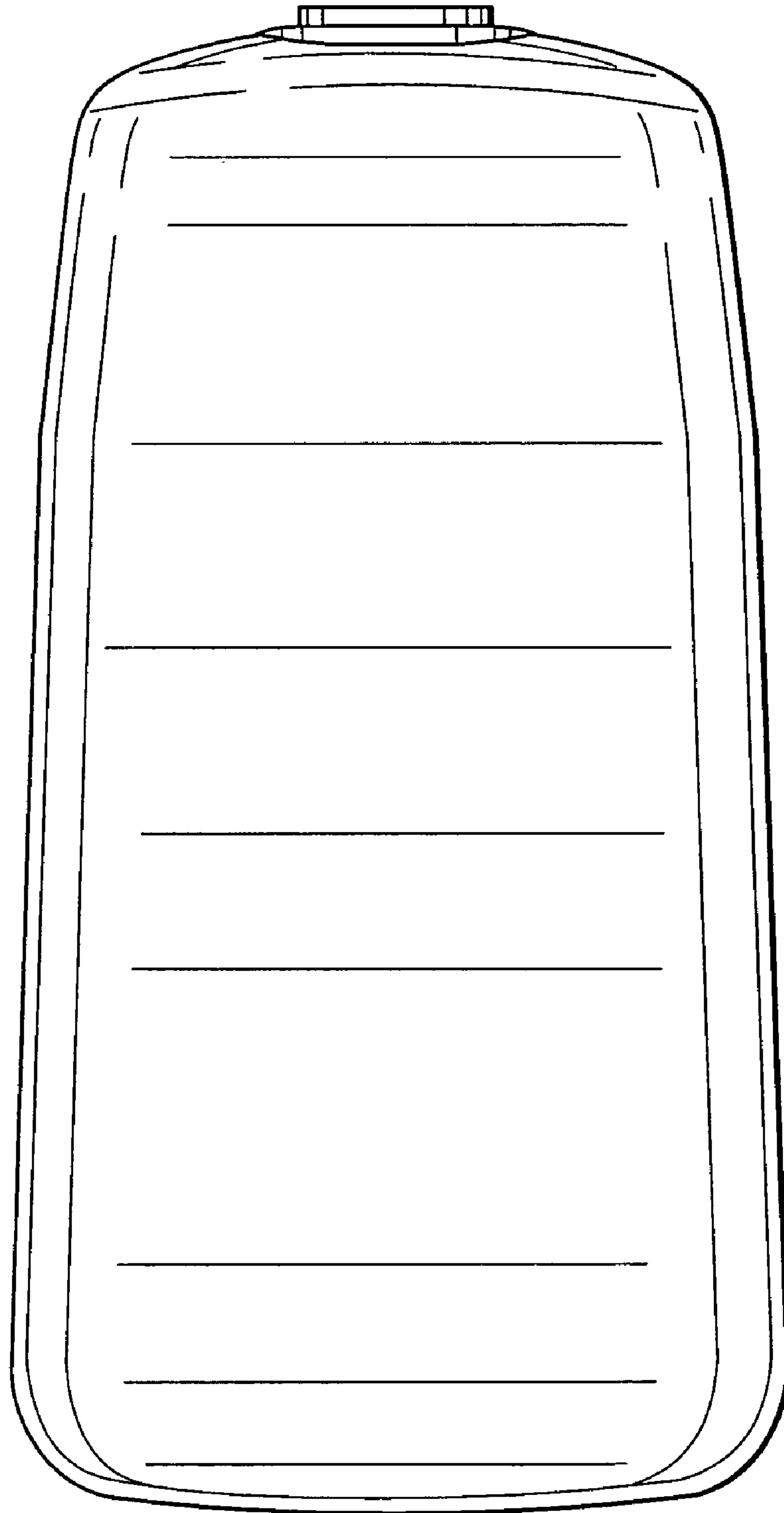




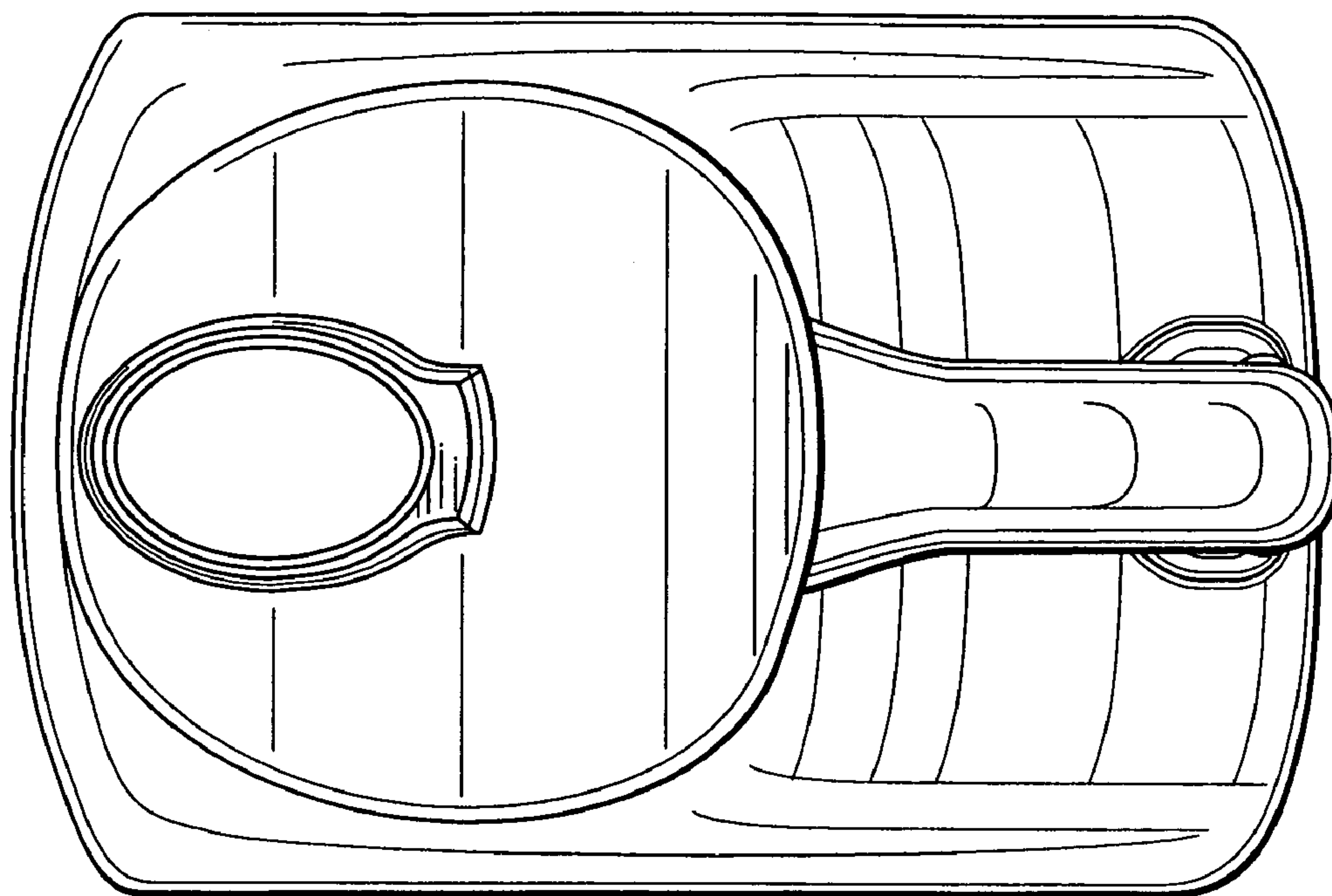
**Fig. 15**



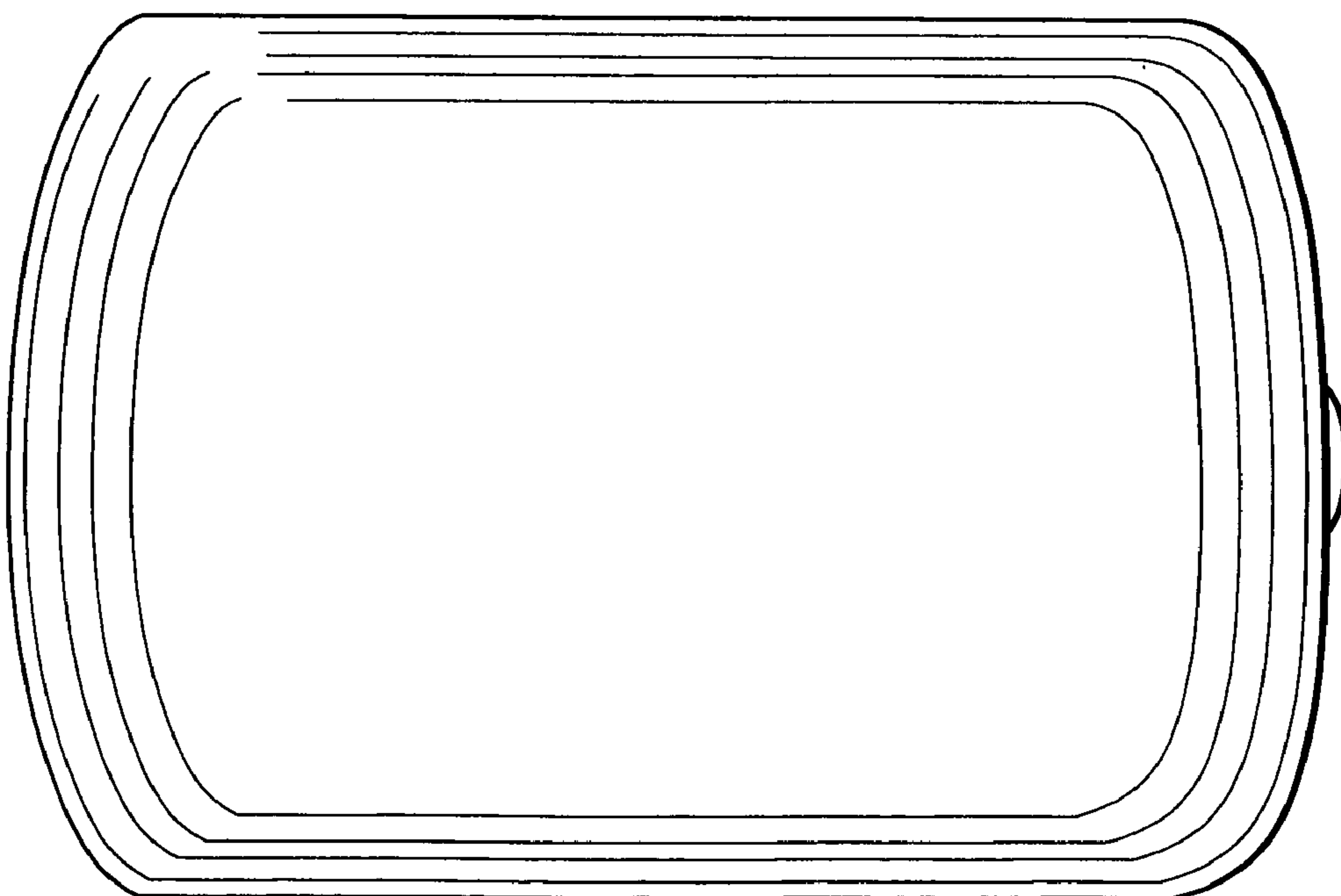
***Fig. 16***



**Fig. 17**



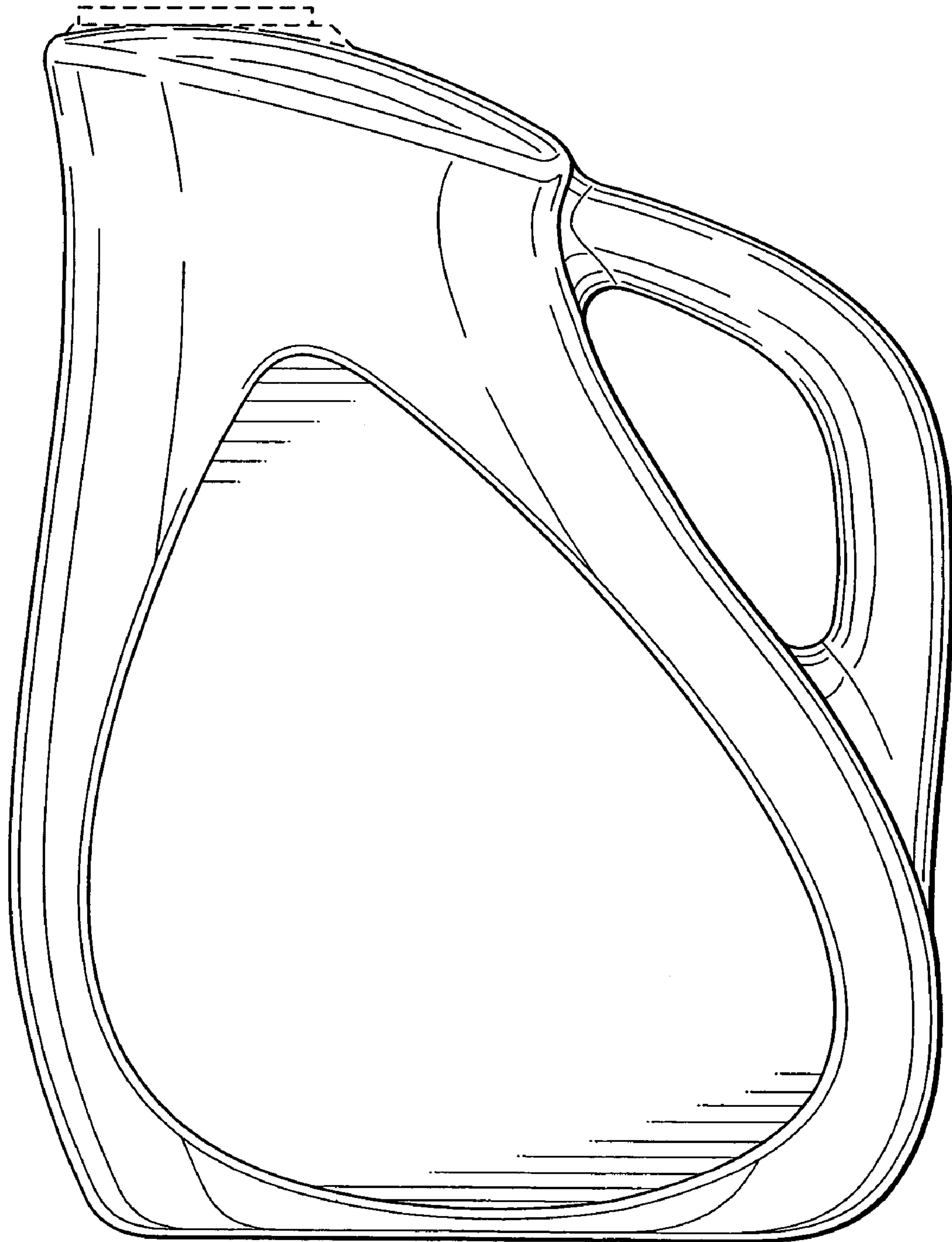
**Fig. 18**



**Fig. 19**

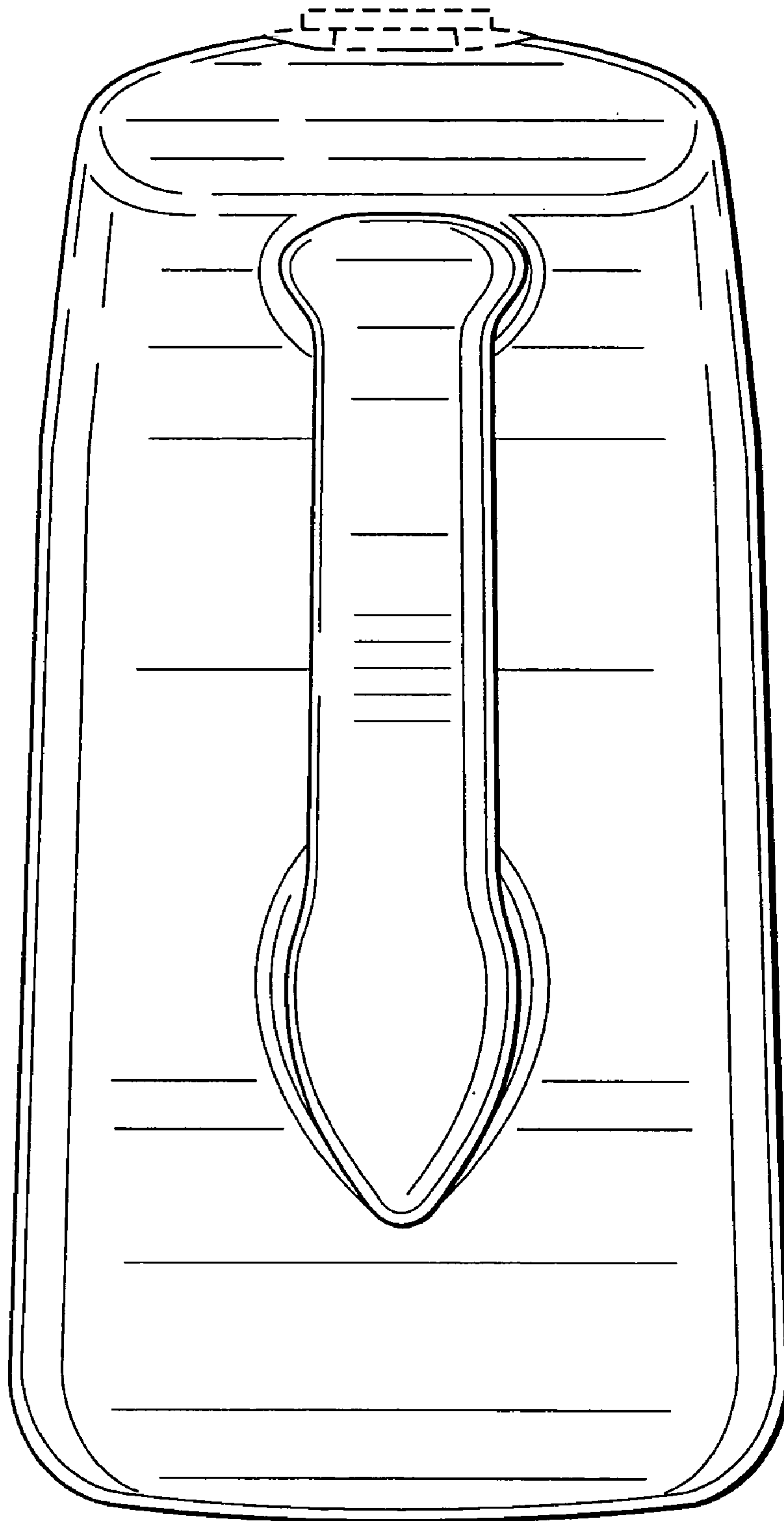


**Fig. 20**

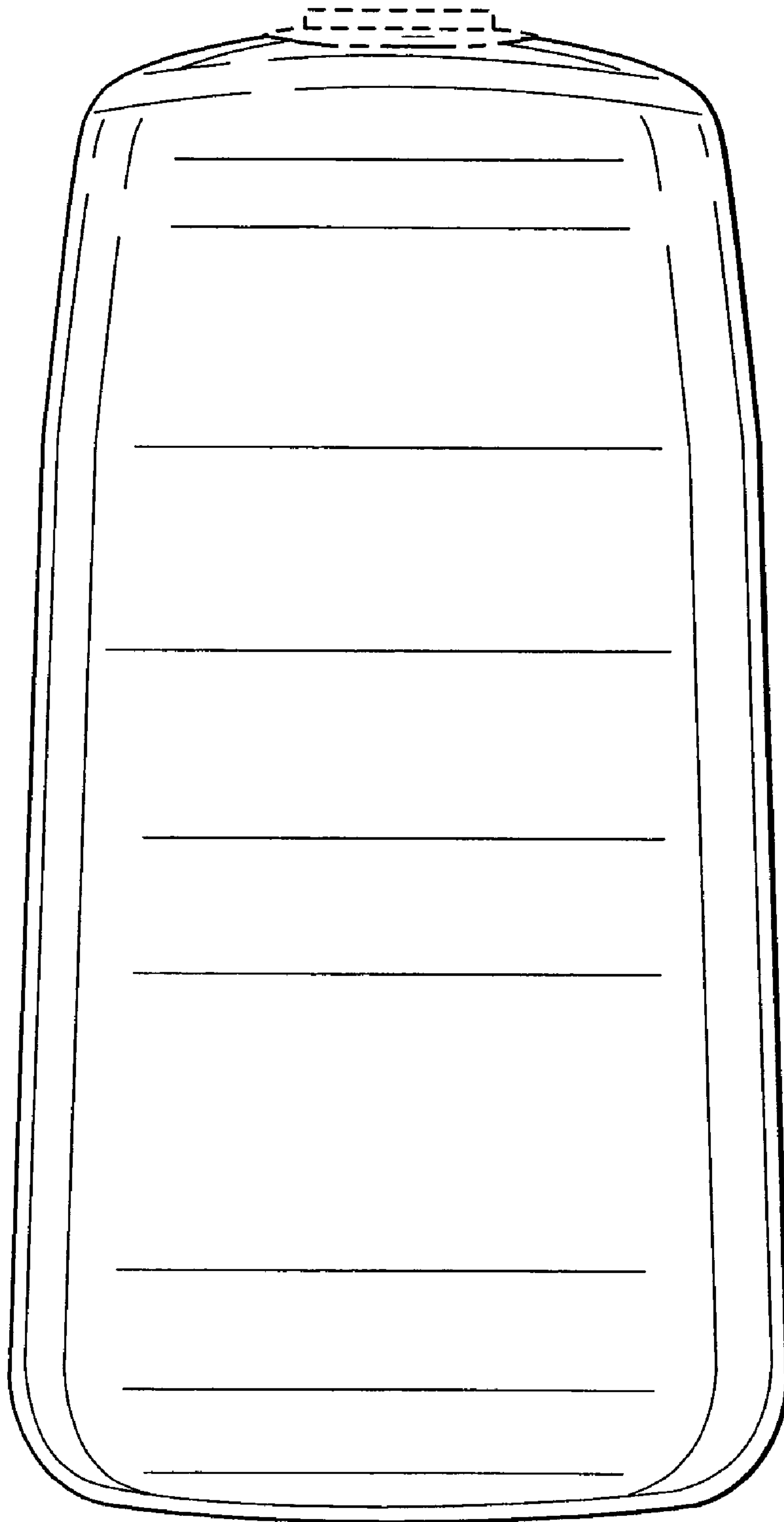




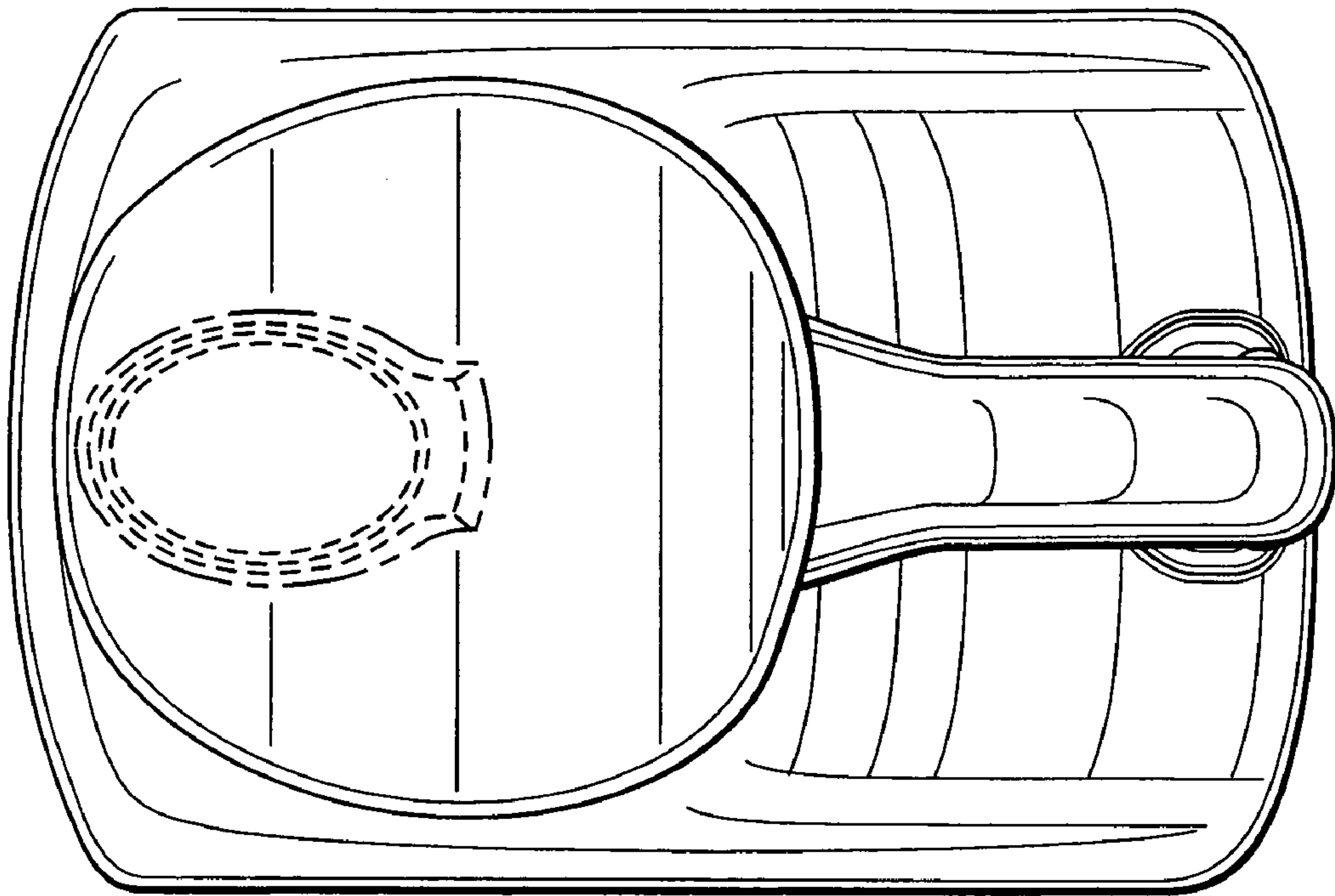
**Fig. 21**



**Fig. 22**



**Fig. 23**



**Fig. 24**

