



US00D563722S

(12) **United States Design Patent**
Thurlow et al.

(10) **Patent No.:** **US D563,722 S**
(45) **Date of Patent:** **** Mar. 11, 2008**

(54) **COOKWARE HANDLE**

(75) Inventors: **Heida L. Thurlow**, Houston, TX (US);
Scott A. Henderson, Brooklyn, NY
(US)

(73) Assignee: **Lentrade, Inc.**, Houston, TX (US)

(**) Term: **14 Years**

(21) Appl. No.: **29/277,318**

(22) Filed: **Feb. 21, 2007**

(51) **LOC (8) Cl.** **07-02**

(52) **U.S. Cl.** **D7/394**

(58) **Field of Classification Search** D7/354-361,
D7/393-395; D8/107, 300, 307, 315, 317;
16/430, 431, 110.1, 407, 416, 419, 443, 444,
16/446; 220/573.1-573.5, 752, 753, 755,
220/756

See application file for complete search history.

(56) **References Cited**

U.S. PATENT DOCUMENTS

D402,530 S	*	12/1998	Simons et al.	D8/317
D482,233 S	*	11/2003	Rae	D7/393
D507,931 S	*	8/2005	Rae	D7/393
D529,334 S	*	10/2006	Spagnolo	D7/394
D542,118 S	*	5/2007	Fields	D8/317

* cited by examiner

Primary Examiner—Holly H. Baynham

Assistant Examiner—Cynthia M. Chin

(74) *Attorney, Agent, or Firm*—Patrick K. Steele; Streets & Steele

(57) **CLAIM**

The ornamental design for a cookware handle, as shown and described.

DESCRIPTION

FIG. 1 is a perspective top view of the cookware handle of the present invention.

FIG. 2 is an exterior elevation view of the cookware handle of FIG. 1.

FIG. 3 is an interior elevation view of the cookware handle of FIGS. 1-2.

FIG. 4 is a top view of the cookware handle of FIGS. 1-3.

FIG. 5 is a bottom view of the cookware handle of FIGS. 1-4; and,

FIG. 6 is a right side elevation view of the cookware handle FIGS. 1-5.

The broken lines showing the pan on FIGS. 1 and 6 are for illustrative purposes only and form no part of the claimed design.

1 Claim, 4 Drawing Sheets

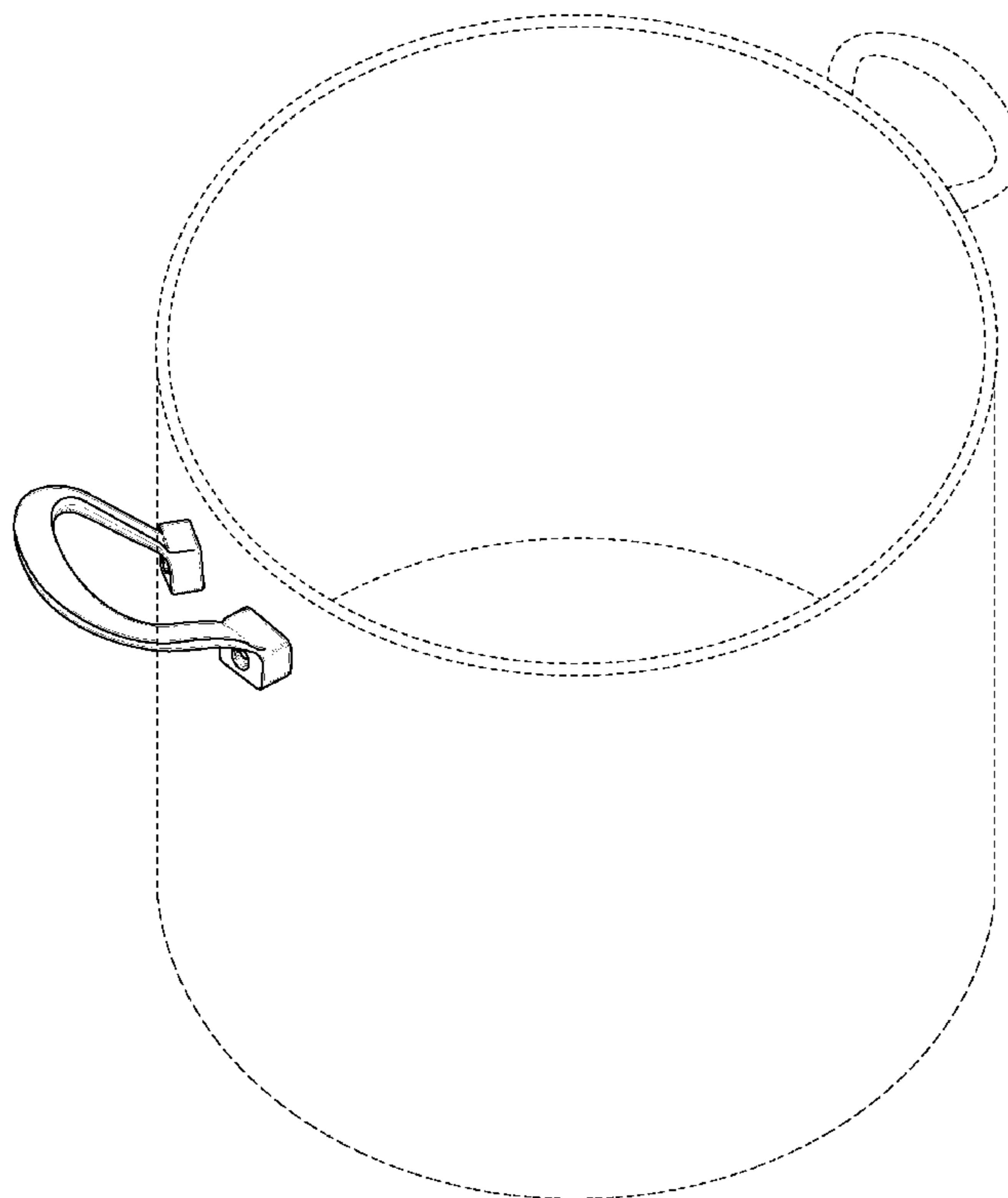

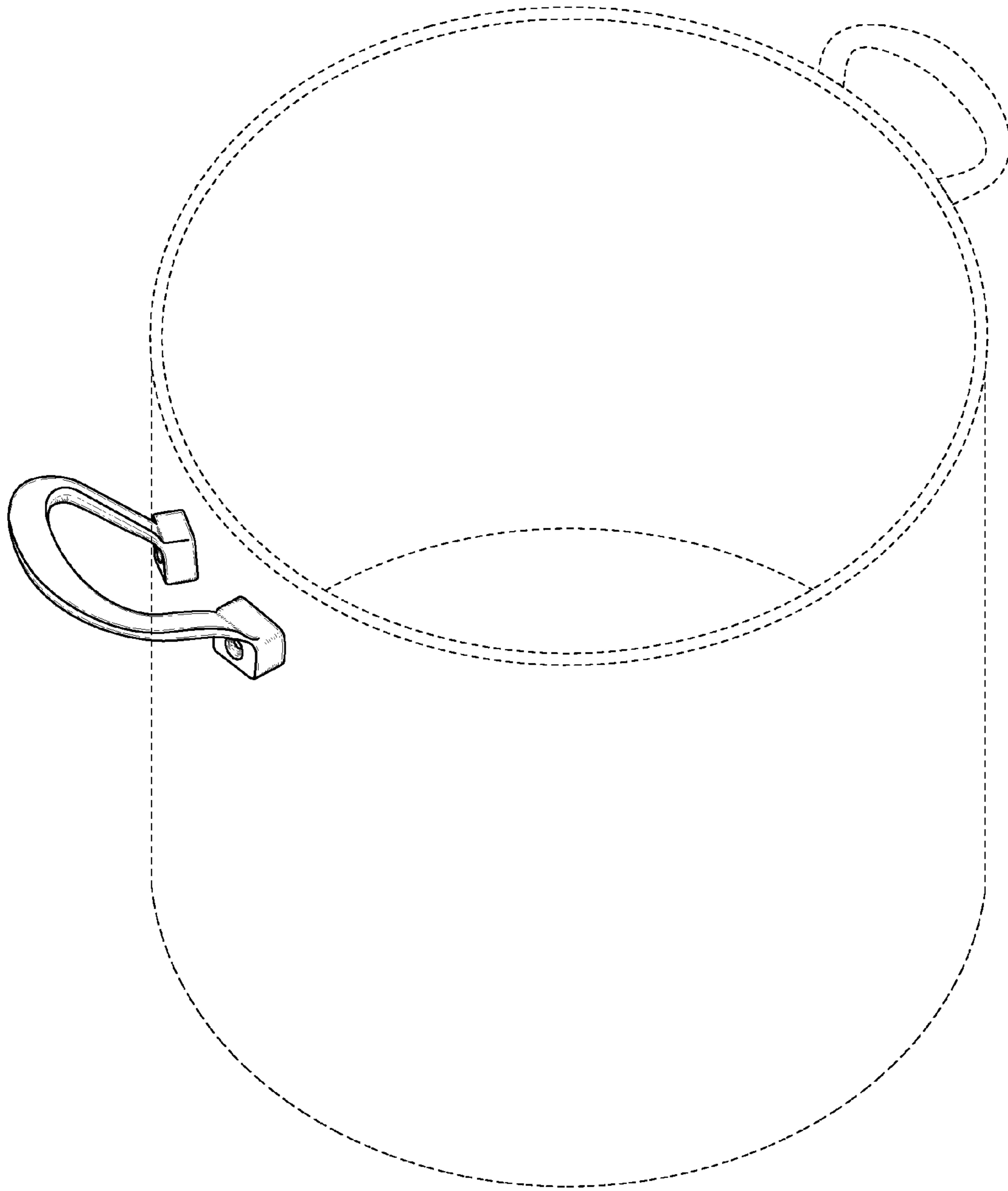

FIG. 1

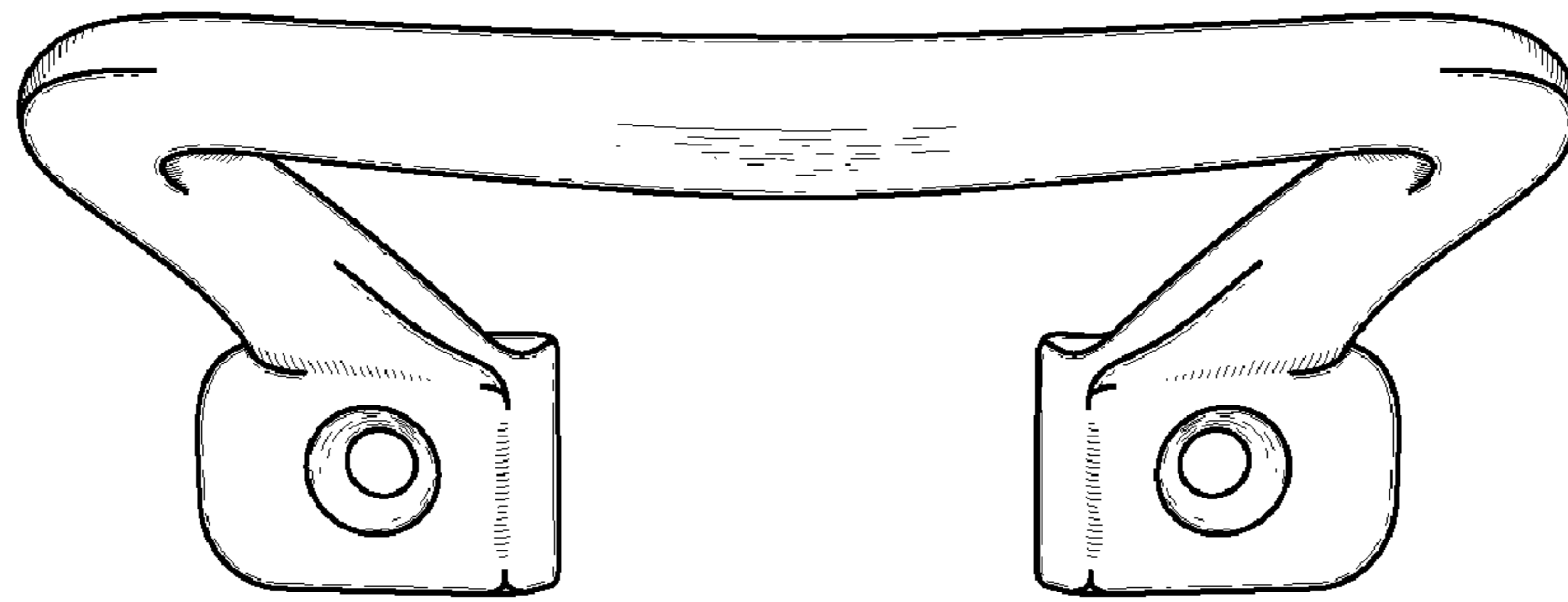

FIG. 2

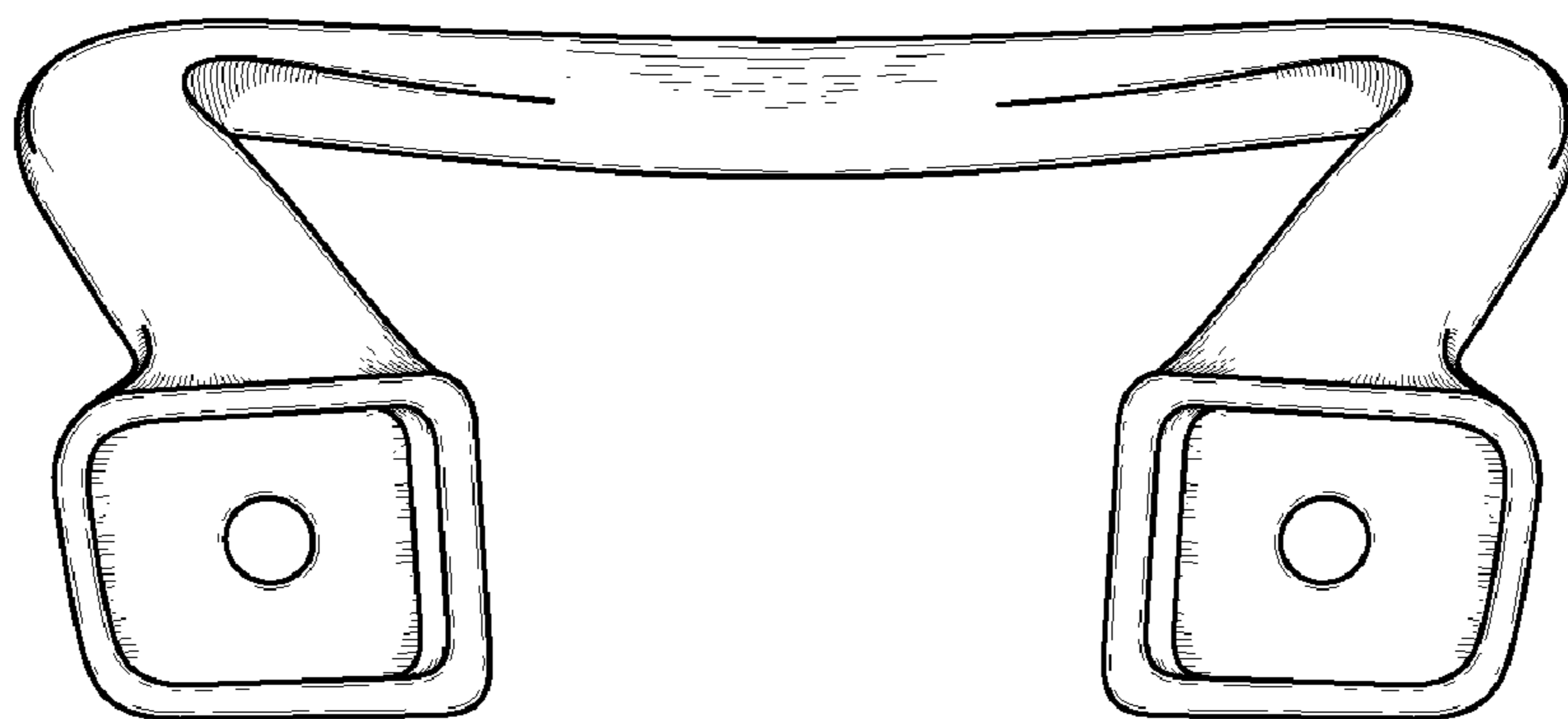

FIG. 3

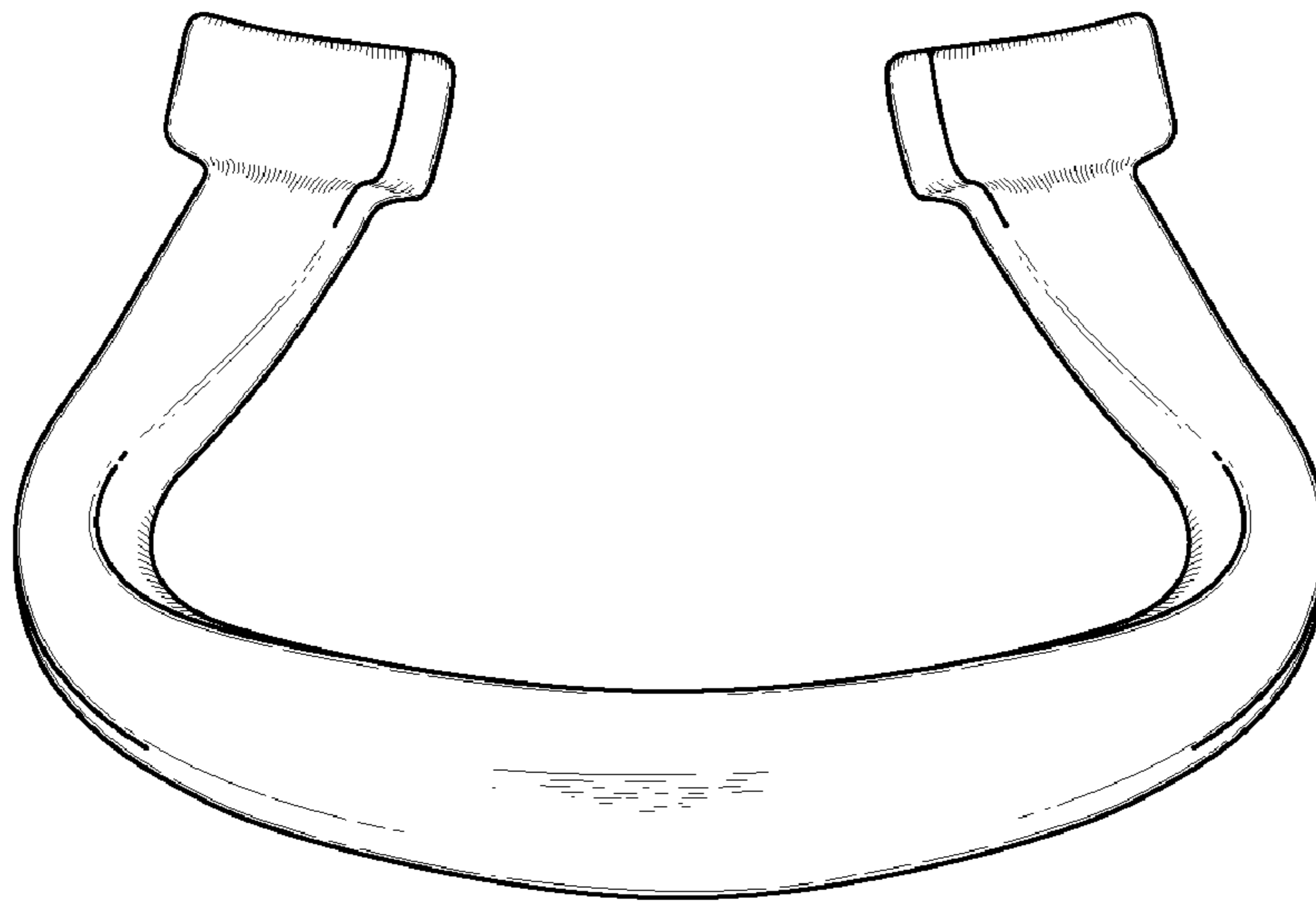

FIG. 4

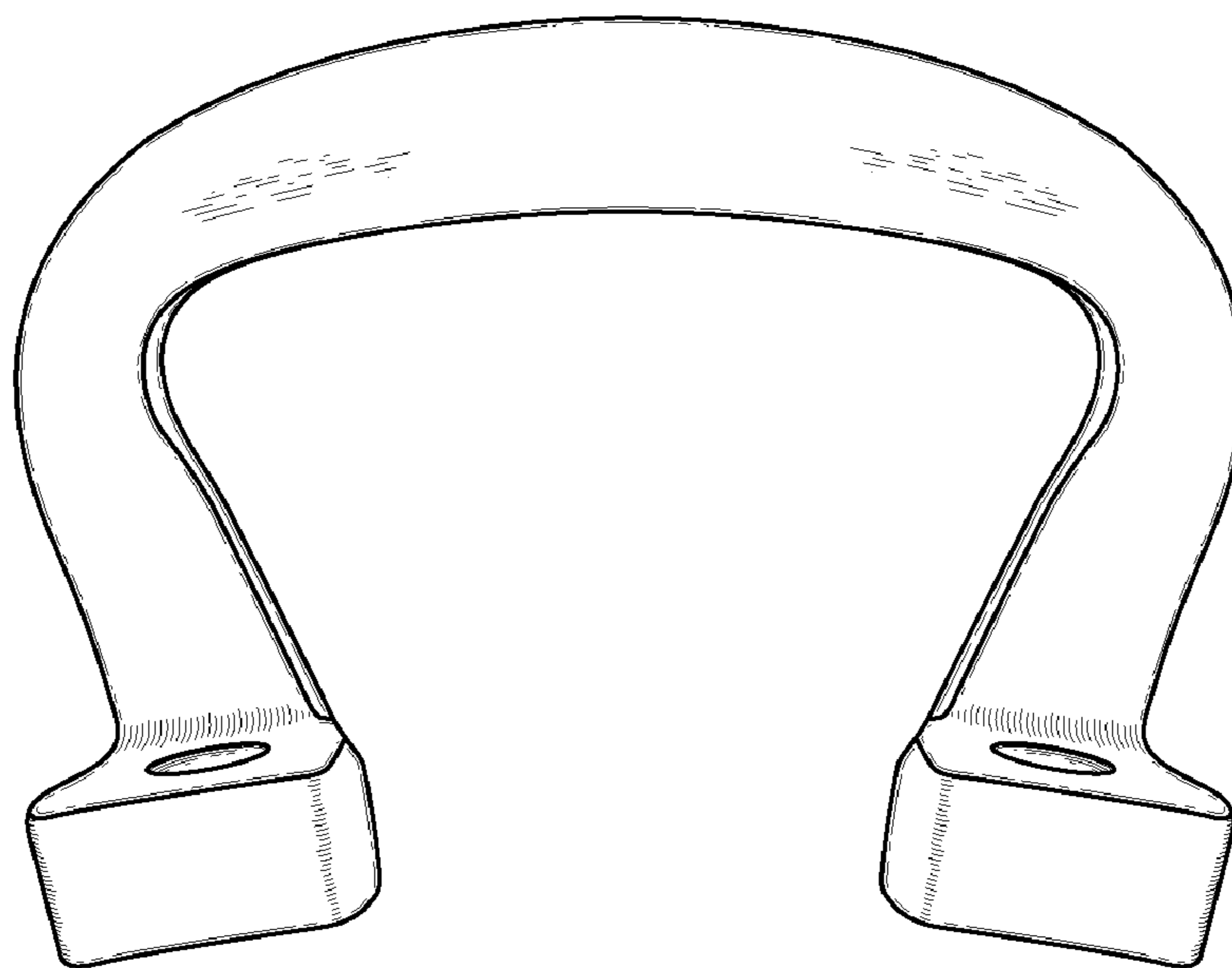

FIG. 5

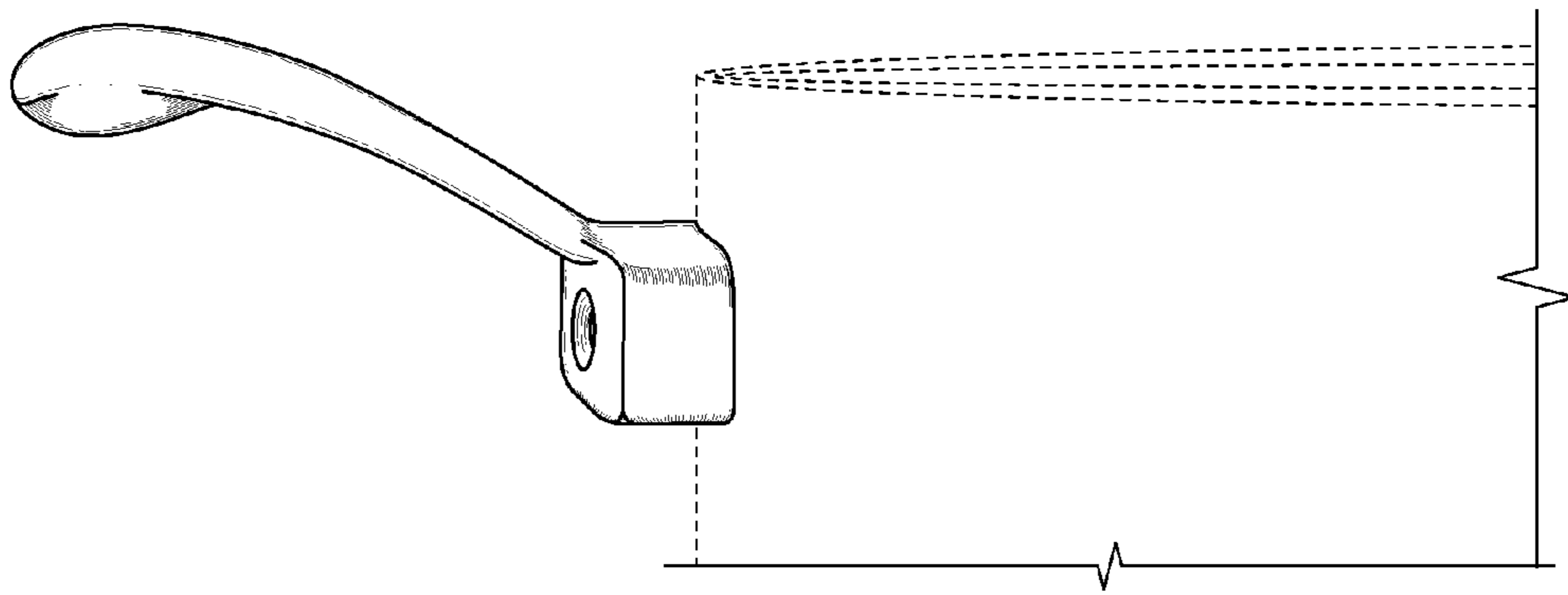

FIG. 6