



US00D563701S

(12) **United States Design Patent**
Duncan

(10) **Patent No.:** **US D563,701 S**
(45) **Date of Patent:** **** Mar. 11, 2008**

(54) **PAPER CUP DISPENSER FOR AIR GAP PIPE**

D477,942 S * 8/2003 Luu et al. D6/516

(75) Inventor: **Scott E. Duncan**, Santa Rosa, CA (US)

* cited by examiner

(73) Assignee: **The Westbrass Company, Inc.**, Los Angeles, CA (US)

Primary Examiner—Brian N Vinson
(74) *Attorney, Agent, or Firm*—Craig M. Stainbrook;
Stainbrook & Stainbrook, LLP

(**) Term: **14 Years**

(57) **CLAIM**

(21) Appl. No.: **29/248,828**

The ornamental design for a paper cup dispenser for air gap pipe, as shown and described.

(22) Filed: **Sep. 6, 2006**

(51) **LOC (8) Cl.** **07-99**

(52) **U.S. Cl.** **D6/516**

(58) **Field of Classification Search** D6/515-516;
206/217, 427; 211/13.1, 49.1, 74; 221/45,
221/282-285; 222/173, 180, 181.1, 181.2
See application file for complete search history.

DESCRIPTION

FIG. 1 is a front left perspective view;
FIG. 2 is a front view in elevation;
FIG. 3 is a right side view in elevation, the left side being a mirror image thereof;
FIG. 4 is a rear view in elevation;
FIG. 5 is a bottom view; and,
FIG. 6 is a top plan view.

The broken-line disclosure in the views is for illustrative purposes only and forms no part of the claimed design.

(56) **References Cited**

U.S. PATENT DOCUMENTS

2,203,494 A *	6/1940	Greenhill	221/45
D241,205 S *	8/1976	Halstead et al.	D6/516
D413,466 S *	9/1999	Warshawsky	D6/516
D421,356 S *	3/2000	Wolff	D6/516

1 Claim, 2 Drawing Sheets

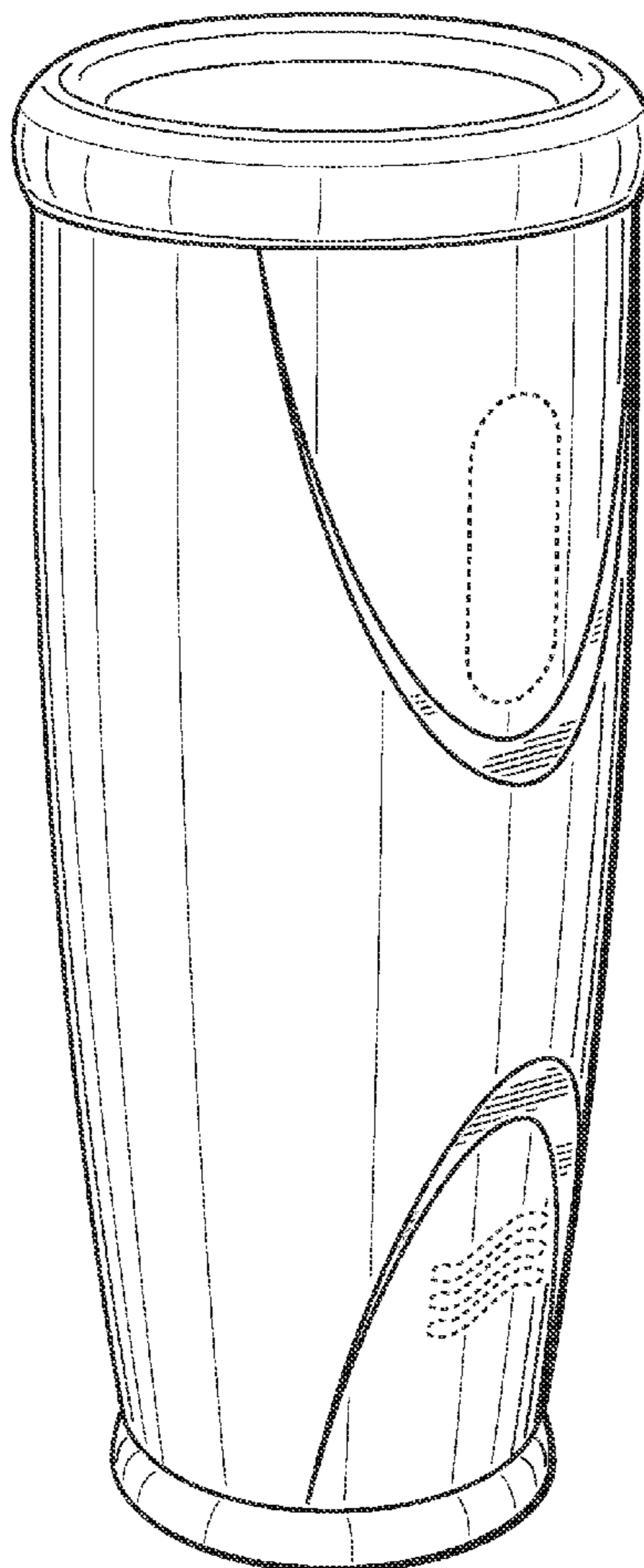

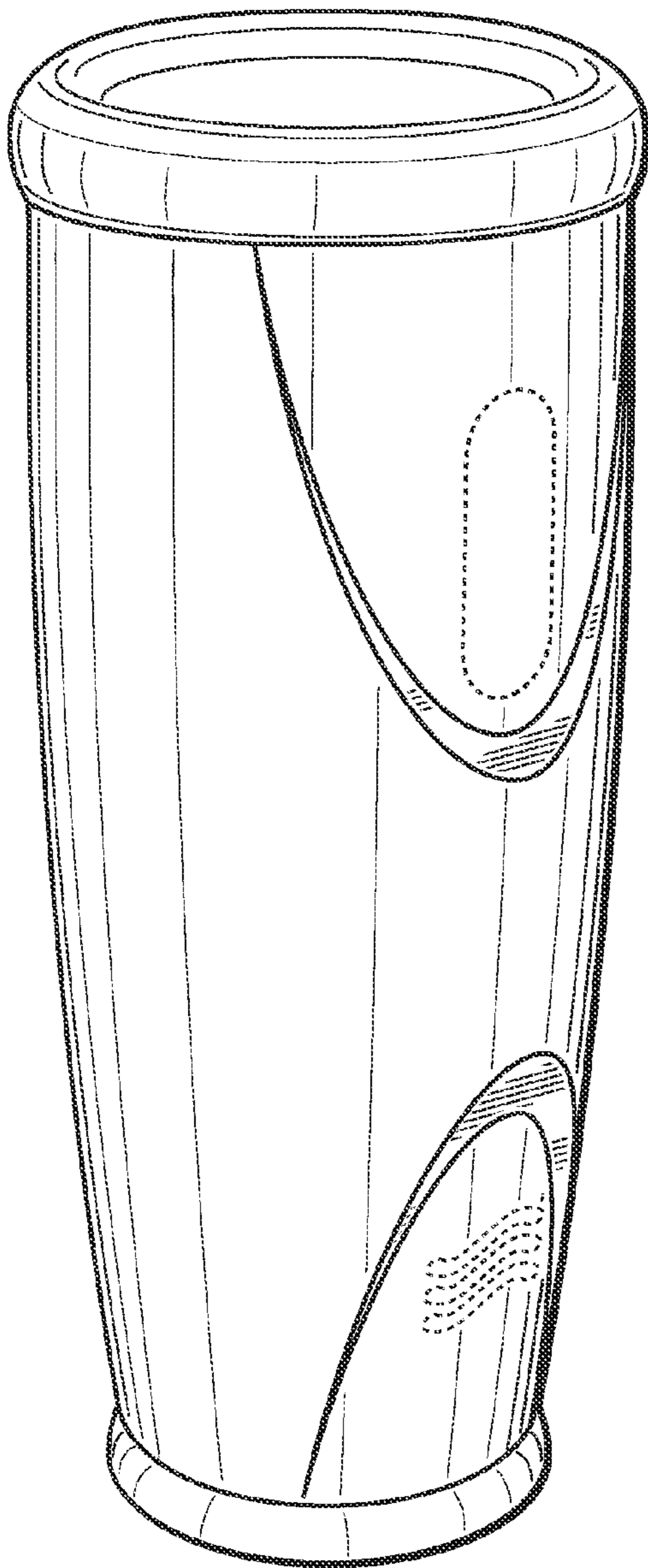

FIG. 1

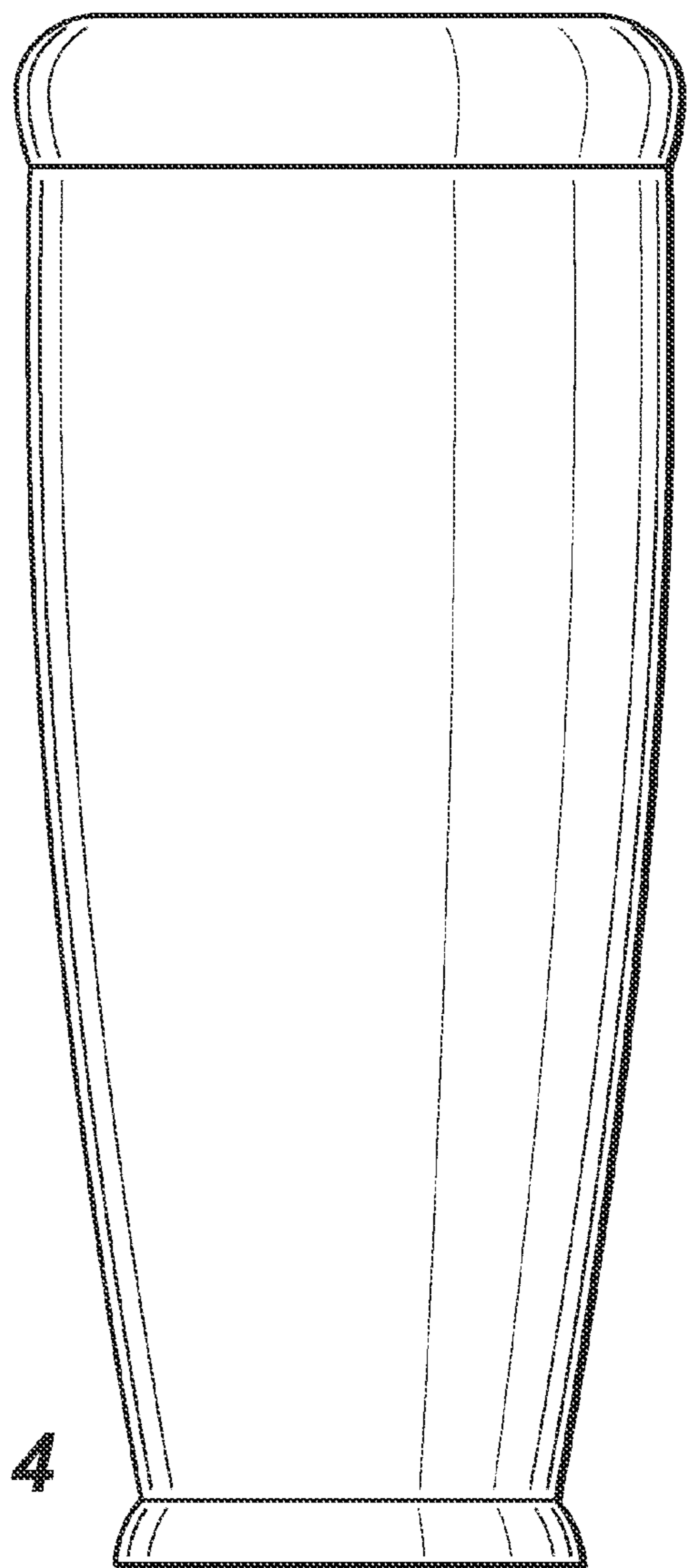

FIG. 4

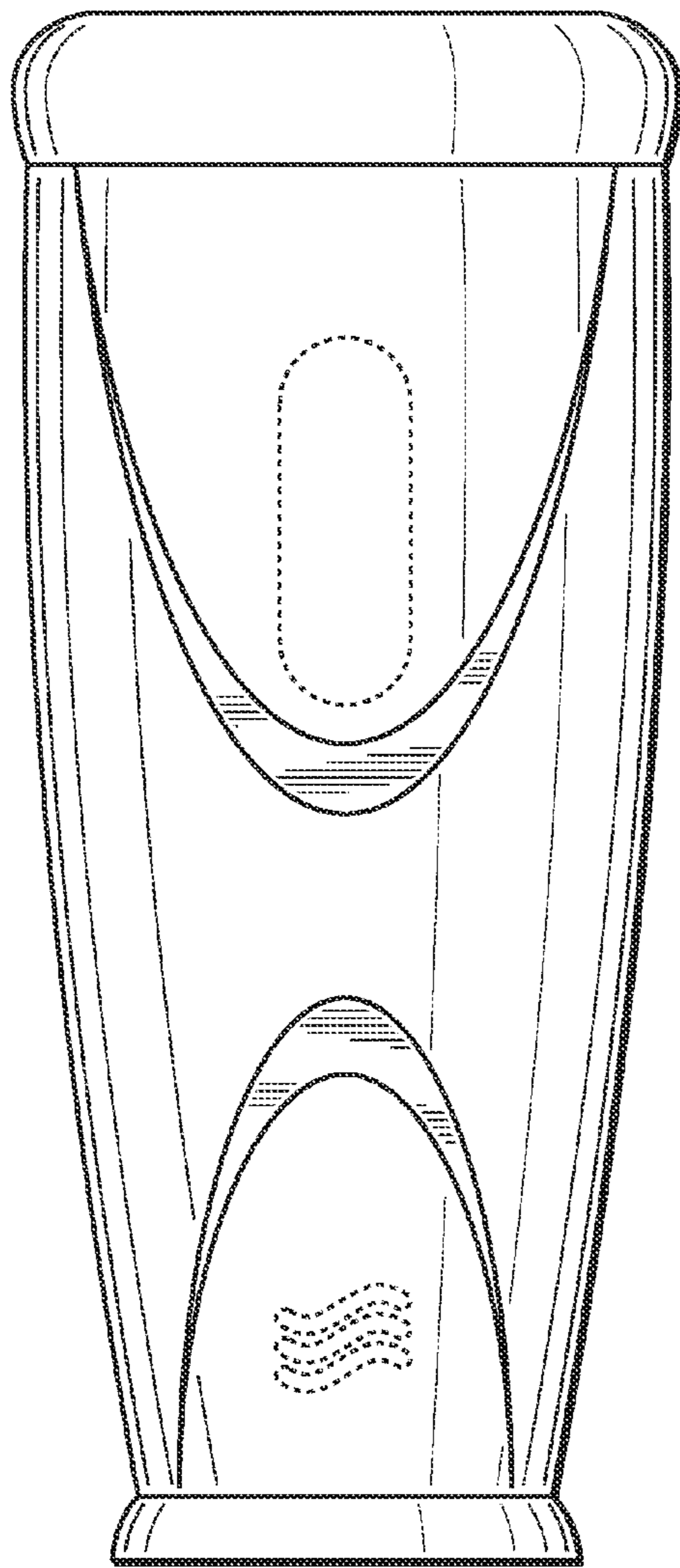

FIG. 2

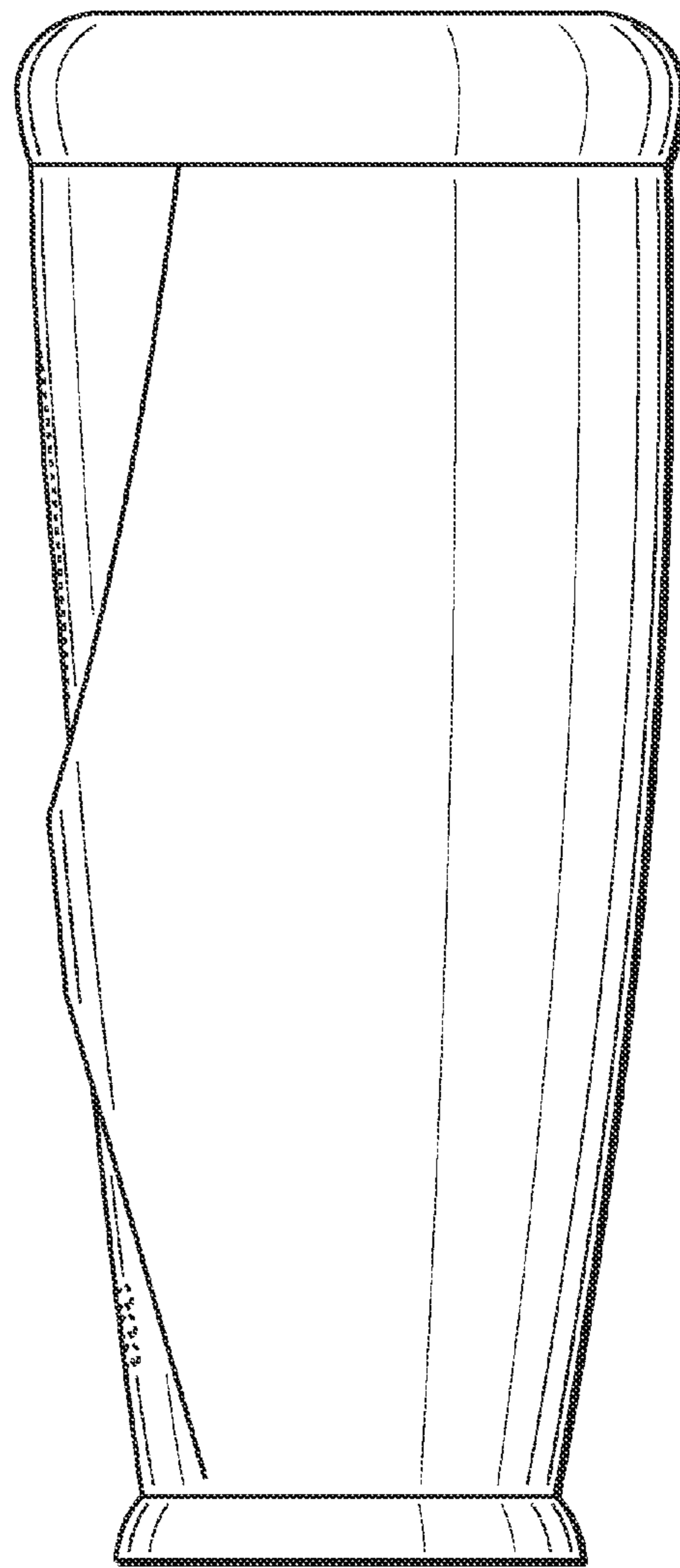

FIG. 3

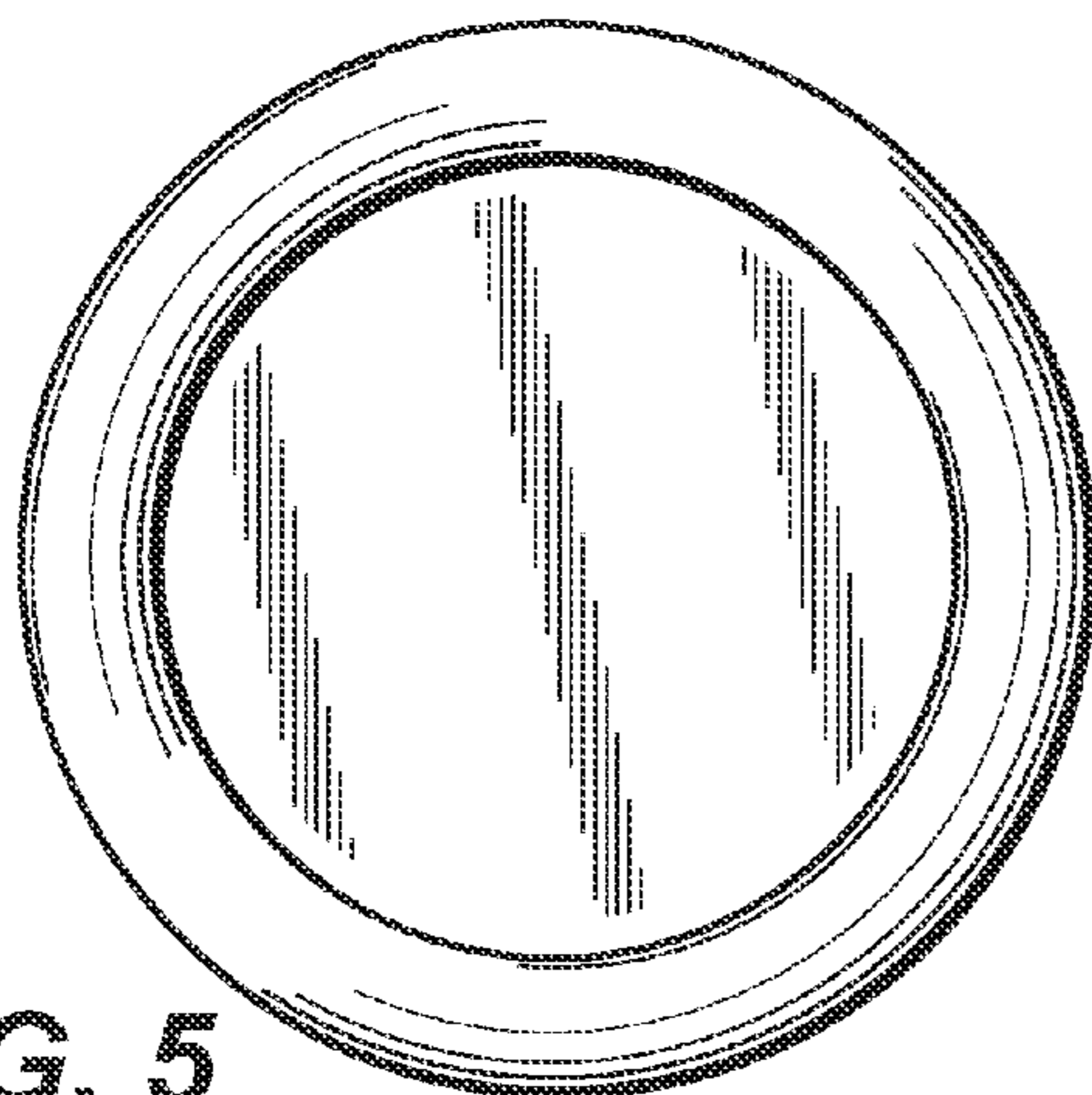

FIG. 5

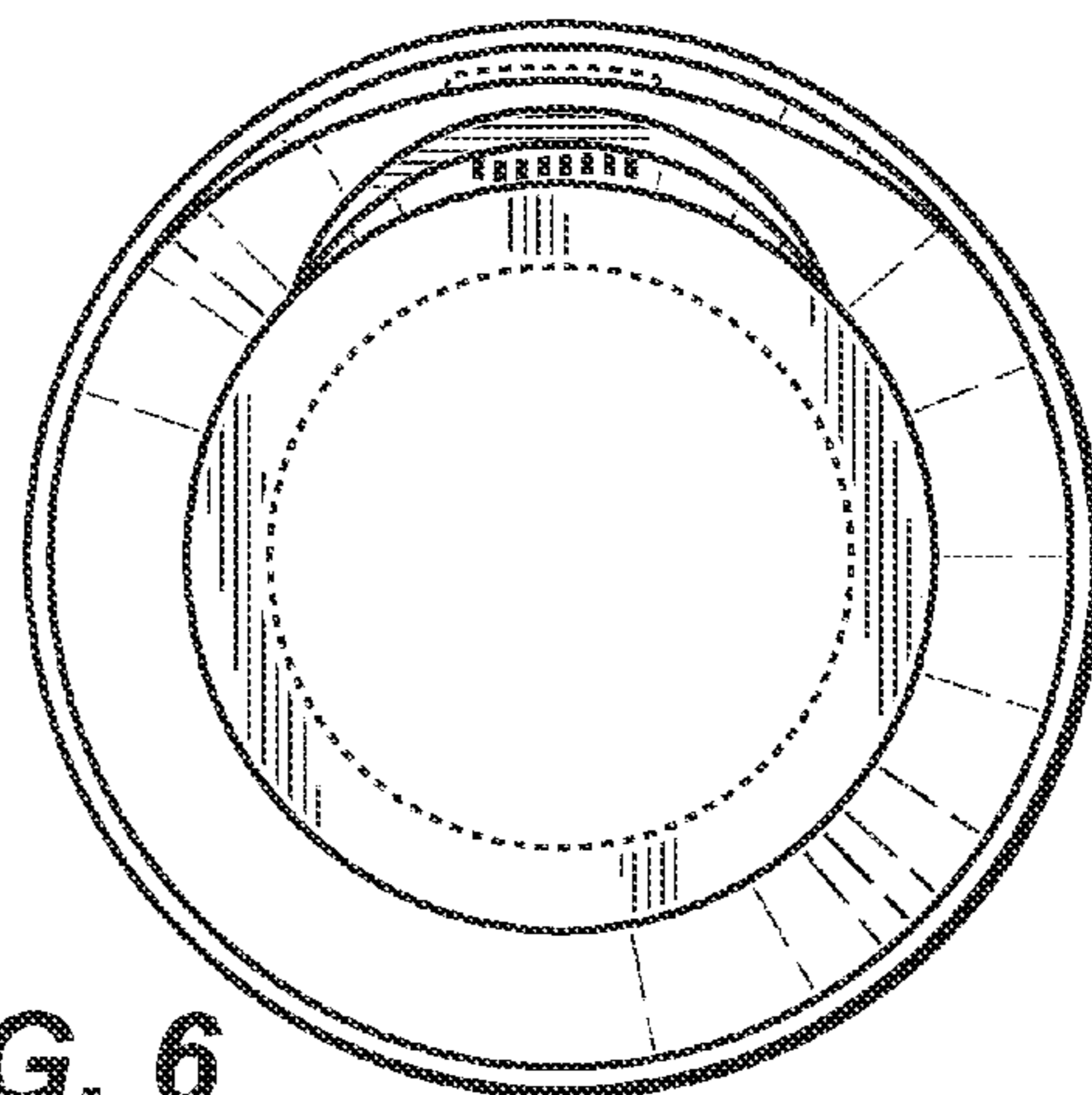

FIG. 6