



US00D563535S

(12) **United States Design Patent**  
**Kergoet**

(10) **Patent No.:** **US D563,535 S**  
(45) **Date of Patent:** **\*\* Mar. 4, 2008**

(54) **LAVATORY**

(75) Inventor: **Francois Kergoet**, Malakoff (FR)

(73) Assignee: **Kohler France SAS**, Paris (FR)

(\*\*) Term: **14 Years**

(21) Appl. No.: **29/276,273**

(22) Filed: **Jan. 19, 2007**

(30) **Foreign Application Priority Data**

Jul. 28, 2006 (EM) ..... 000567870

(51) **LOC (8) Cl.** ..... **23-02**

(52) **U.S. Cl.** ..... **D23/293.1**

(58) **Field of Classification Search** ..... D23/271-274,  
D23/284-293.1, 303, 308; 4/619, 624, 661  
See application file for complete search history.

(56) **References Cited**

**U.S. PATENT DOCUMENTS**

D282,201 S 1/1986 Doman

(Continued)

**OTHER PUBLICATIONS**

Kohler Co. Escalé Handbasin 500x290mm—1 Tap Hole  
White—CPHart.co.uk online catalog. Copyright C.P. Hart.

(Continued)

*Primary Examiner*—Robert A. Delehanty

(74) *Attorney, Agent, or Firm*—Quarles & Brady LLP

(57) **CLAIM**

The ornamental design for a lavatory, as shown and described.

**DESCRIPTION**

In a preferred embodiment, the nature of this product is as a plumbing fixture in the form of a lavatory which is primarily useful for washing the body parts of humans.

FIG. 1 is a right, top, front perspective view of a lavatory embodying my new design;

FIG. 2 is a front elevational view thereof;

FIG. 3 is a rear elevational view thereof;

FIG. 4 is a right side elevational view thereof;

FIG. 5 is a left side elevational view thereof;

FIG. 6 is a top plan view thereof;

FIG. 7 is a bottom plan view thereof;

FIG. 8 is a right, top, front perspective view of a lavatory according to another embodiment of my new design;

FIG. 9 is a front elevational view thereof;

FIG. 10 is a rear elevational view thereof;

FIG. 11 is a right side elevational view thereof;

FIG. 12 is a left side elevational view thereof;

FIG. 13 is a top plan view thereof;

FIG. 14 is a bottom plan view thereof;

FIG. 15 is a right, top, front perspective view of a lavatory according to another embodiment of my new design;

FIG. 16 is a front elevational view thereof;

FIG. 17 is a rear elevational view thereof;

FIG. 18 is a right side elevational view thereof;

FIG. 19 is a left side elevational view thereof;

FIG. 20 is a top plan view thereof;

FIG. 21 is a bottom plan view thereof;

FIG. 22 is a right, top, front perspective view of a lavatory according to another embodiment of my new design;

FIG. 23 is a front elevational view thereof;

FIG. 24 is a rear elevational view thereof;

FIG. 25 is a right side elevational view thereof;

FIG. 26 is a left side elevational view thereof;

FIG. 27 is a top plan view thereof; and,

FIG. 28 is a bottom plan view thereof.

The broken line representations in FIGS. 15-22 and 27-28 are for the purpose of illustration only, and form no part of the claimed design.

**1 Claim, 16 Drawing Sheets**

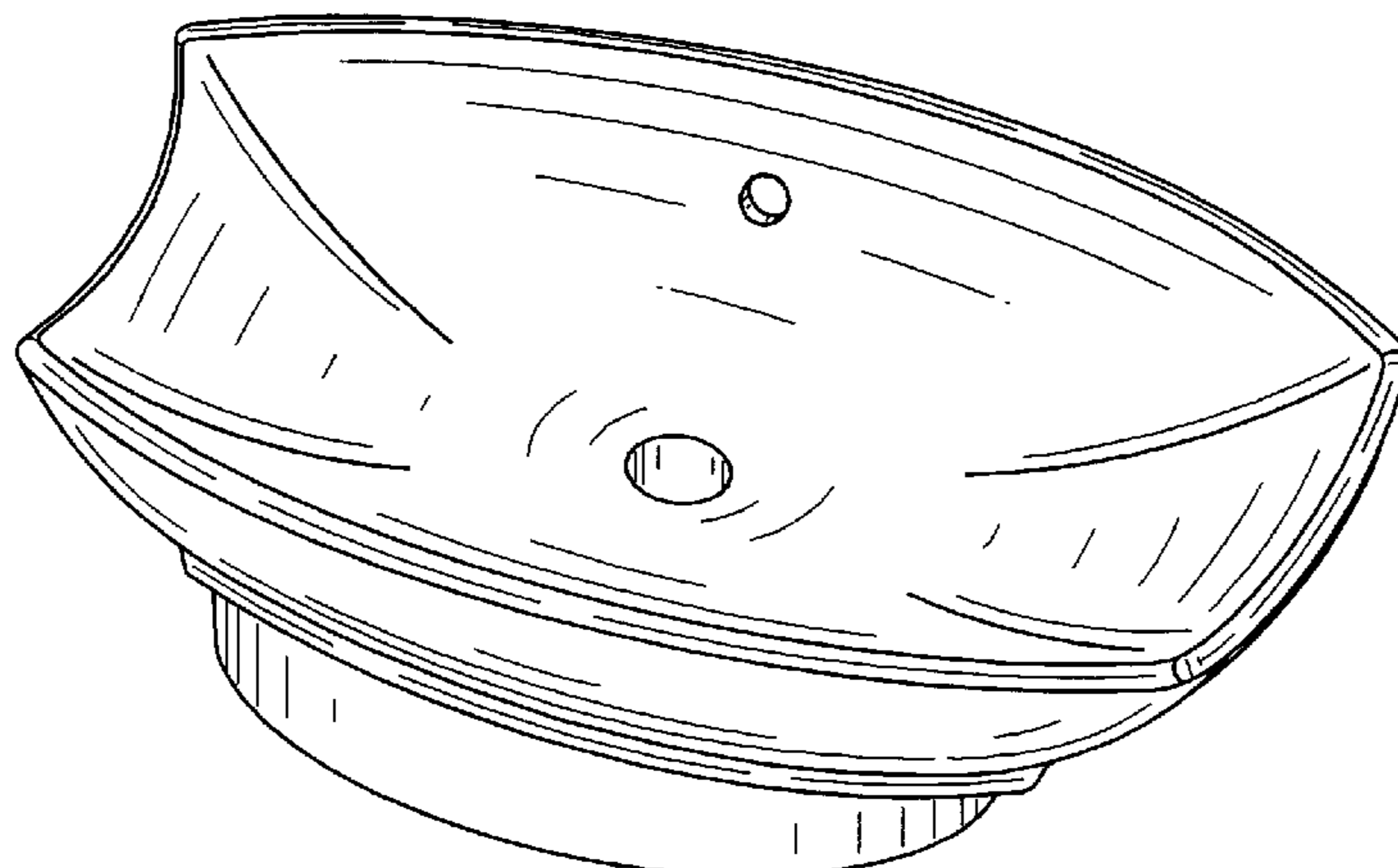

# US D563,535 S

Page 2

---

## U.S. PATENT DOCUMENTS

D351,460 S 10/1994 Kohler, Jr. et al.  
D416,991 S \* 11/1999 Caplow ..... D23/284  
D424,180 S 5/2000 Chiu  
D545,414 S \* 6/2007 Maruhashi et al. .... D23/293.1

## OTHER PUBLICATIONS

Kohler Co. "Escale Vessel with Overflow—41×41CM Nth White"  
CPHart.co.uk online catalog. Copyright C.P. Hart.

Kohler Co. DemiLav Lavatory Sink Vapour Blue—18 1/4" × 15  
5/8" Model No.: 2833-KC. Homecenter.com online catalog. Copy-  
right 1999-2005 HomeCenter.

Hastings. "Nido basin only" Model No.: RAP-WH-NIDOB  
Plumbtile online catalog. Copyright 2004-2006 PlumbTile.

\* cited by examiner

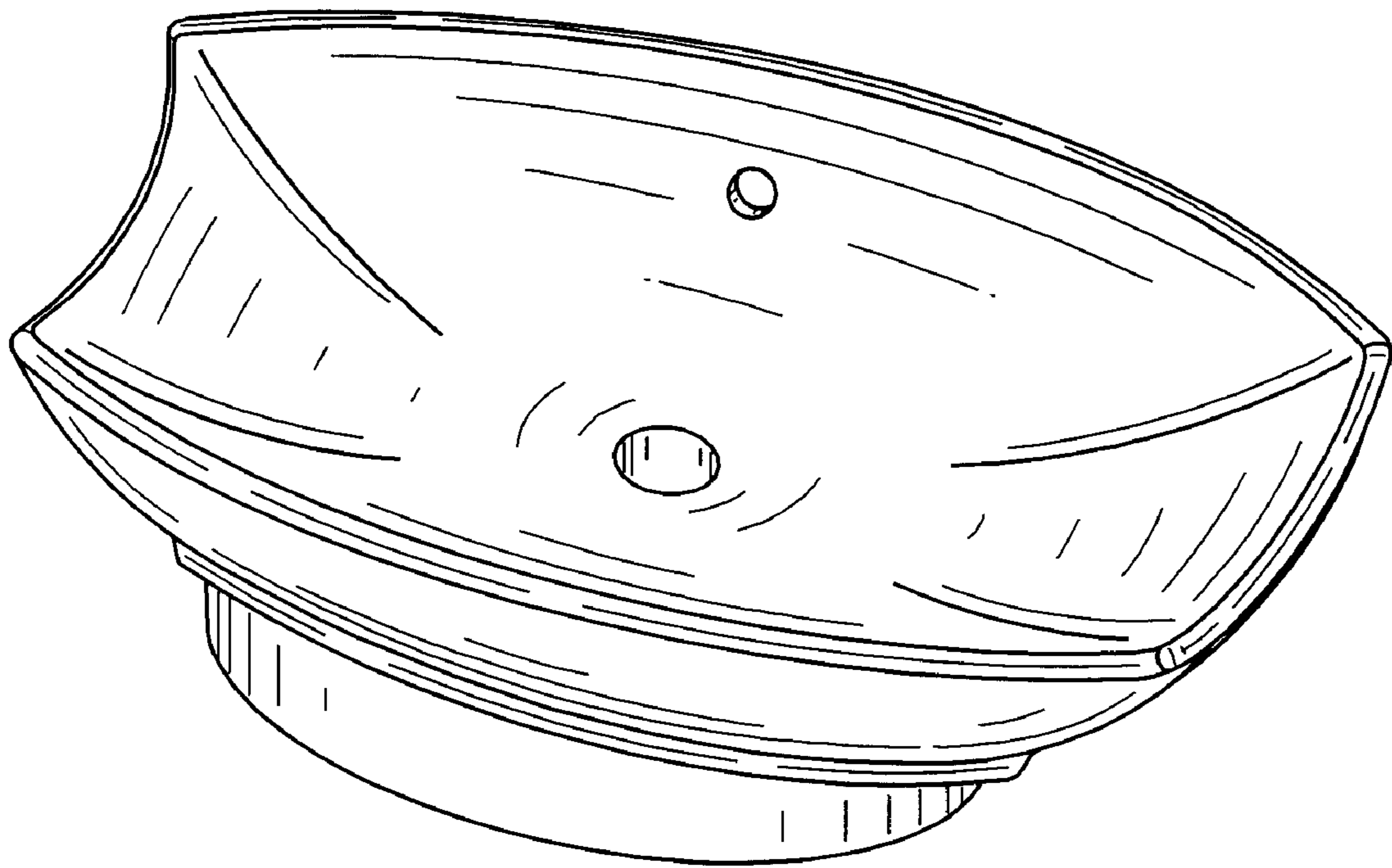

FIG. 1

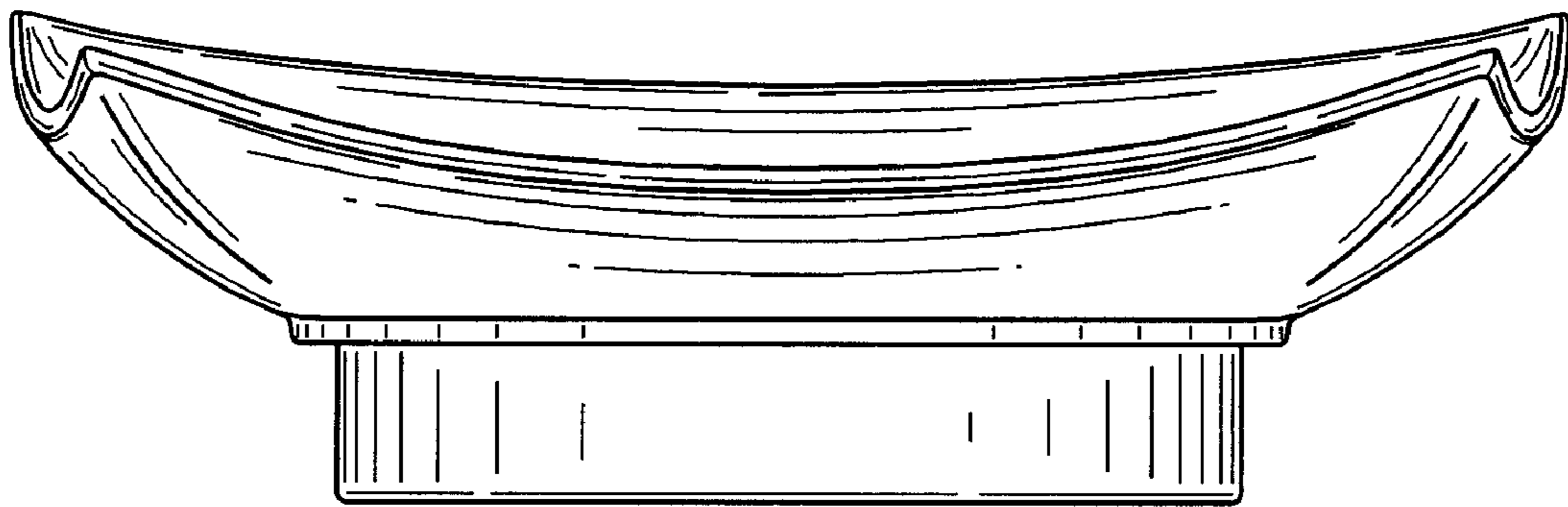

FIG. 2

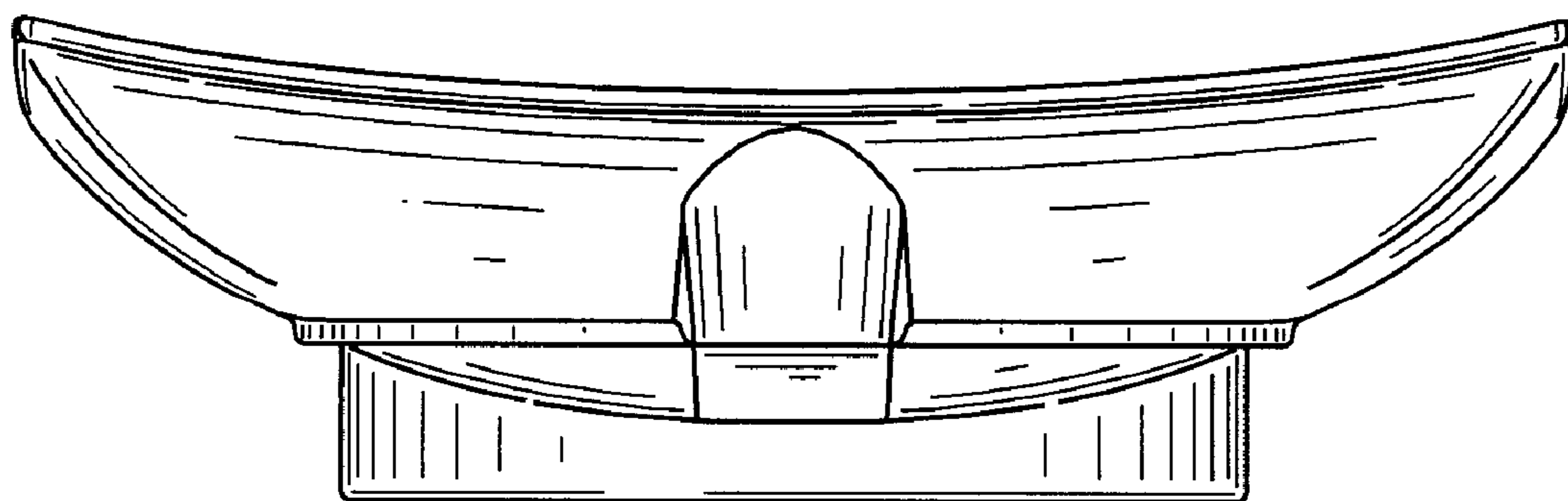

FIG. 3

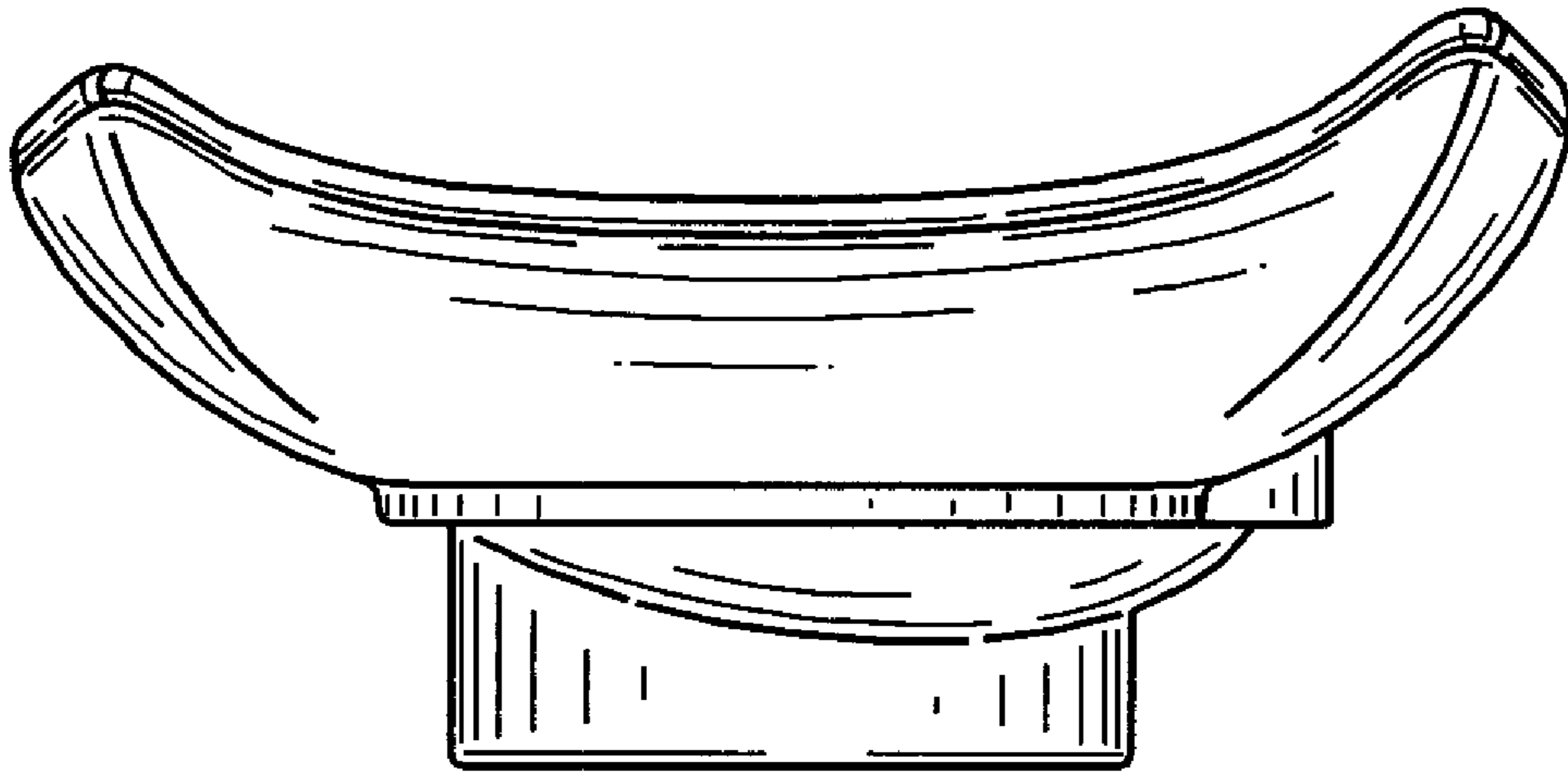

FIG. 4

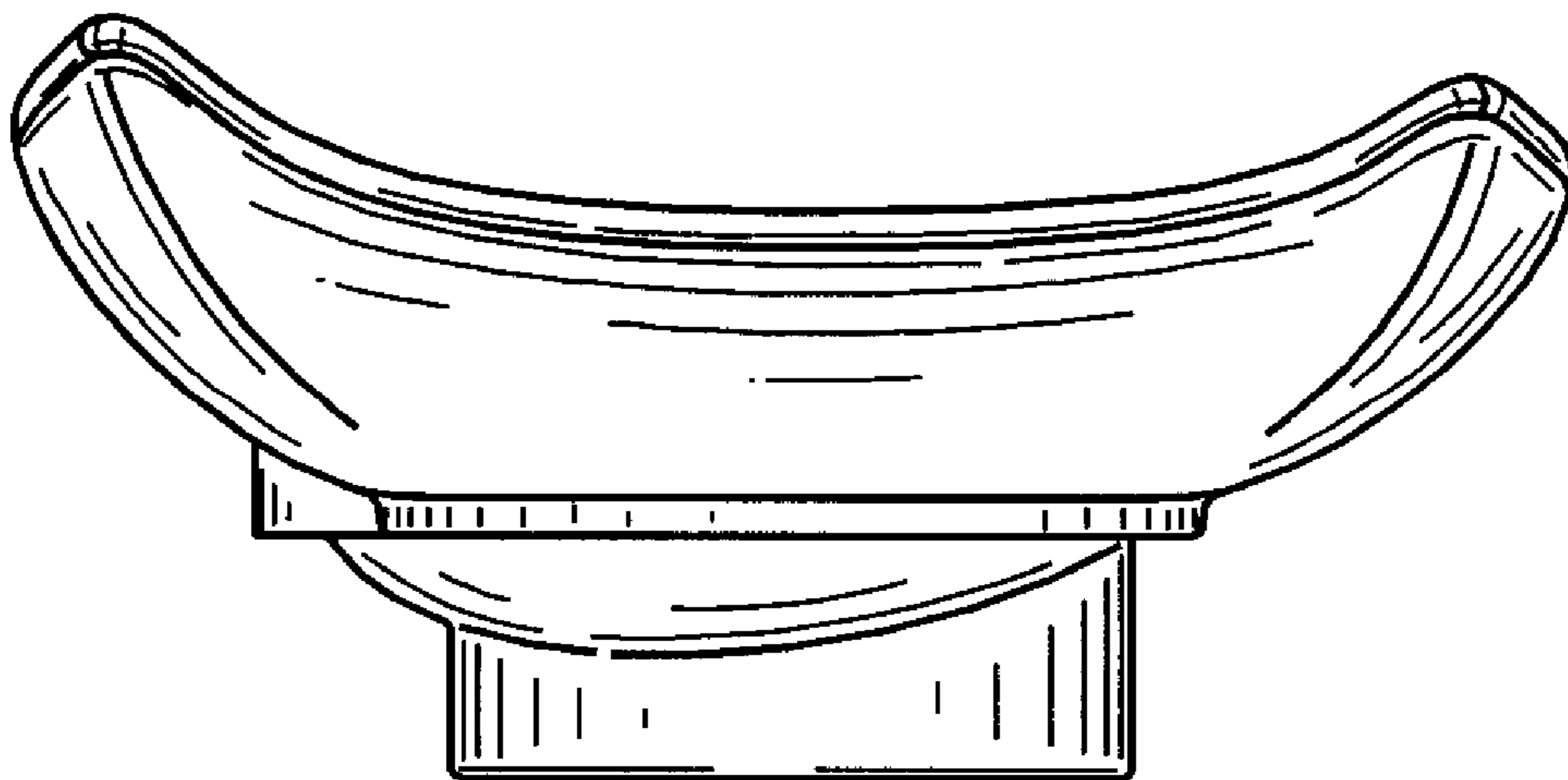

FIG. 5



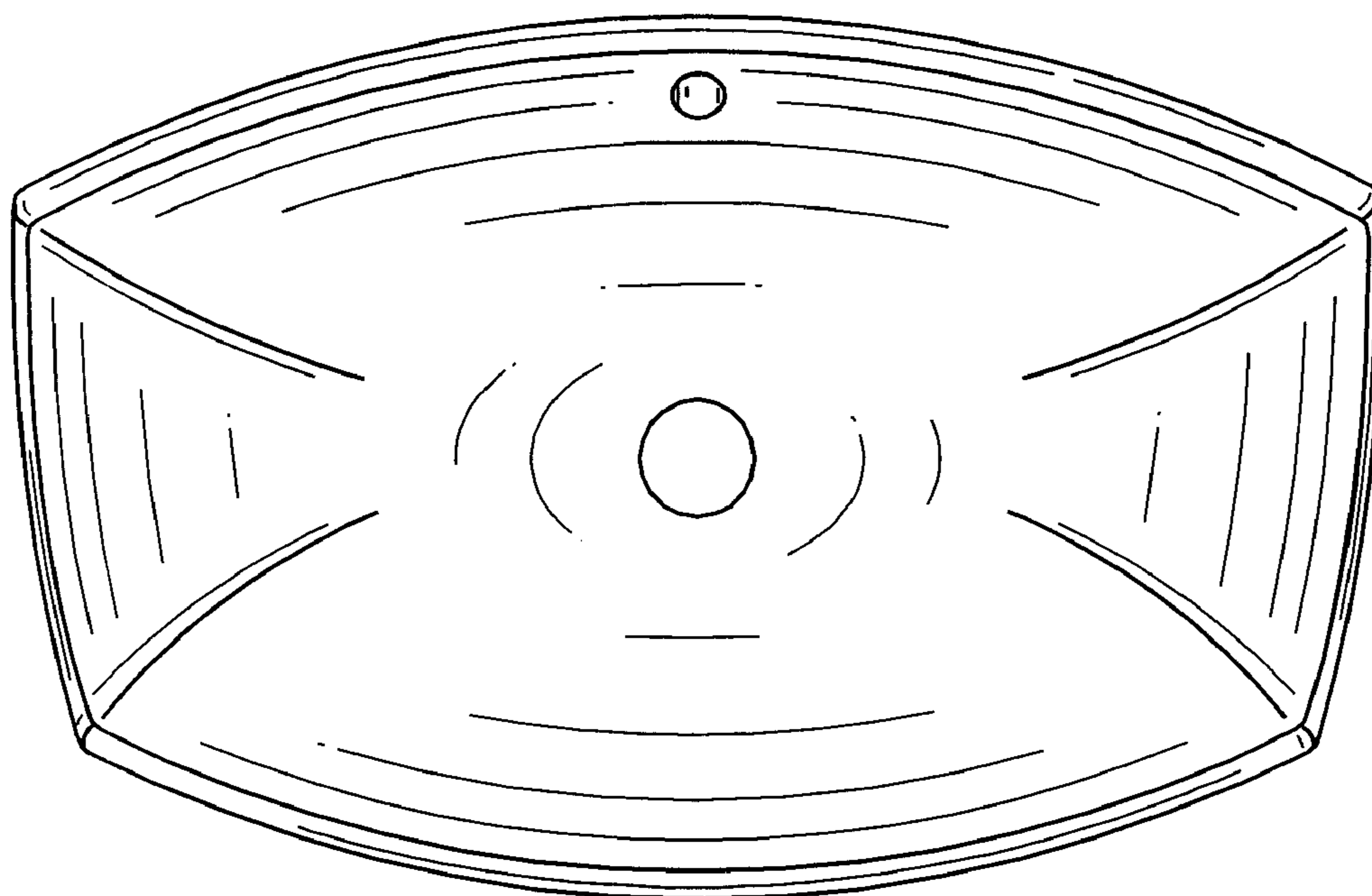

FIG. 6

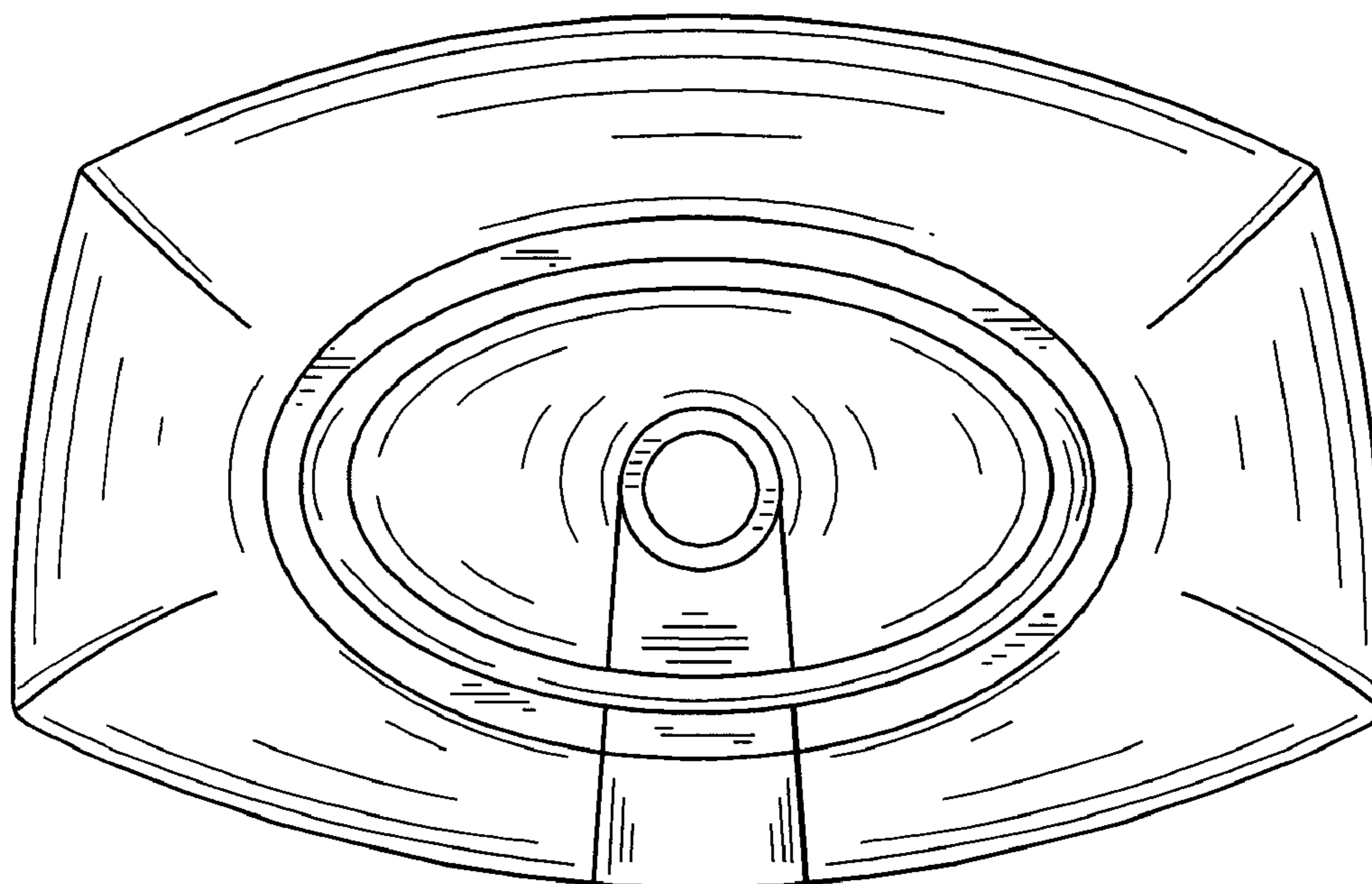

FIG. 7

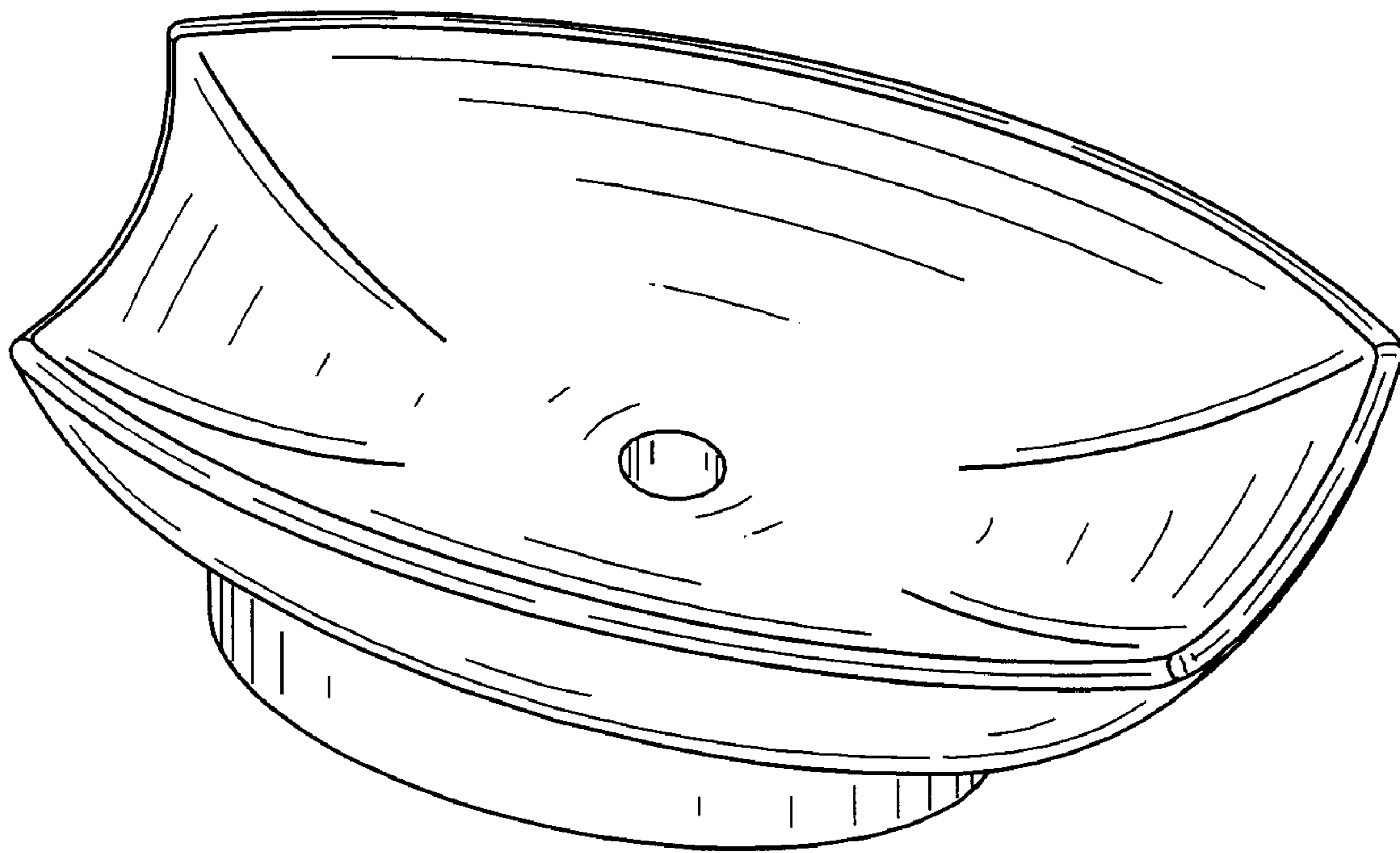

FIG. 8

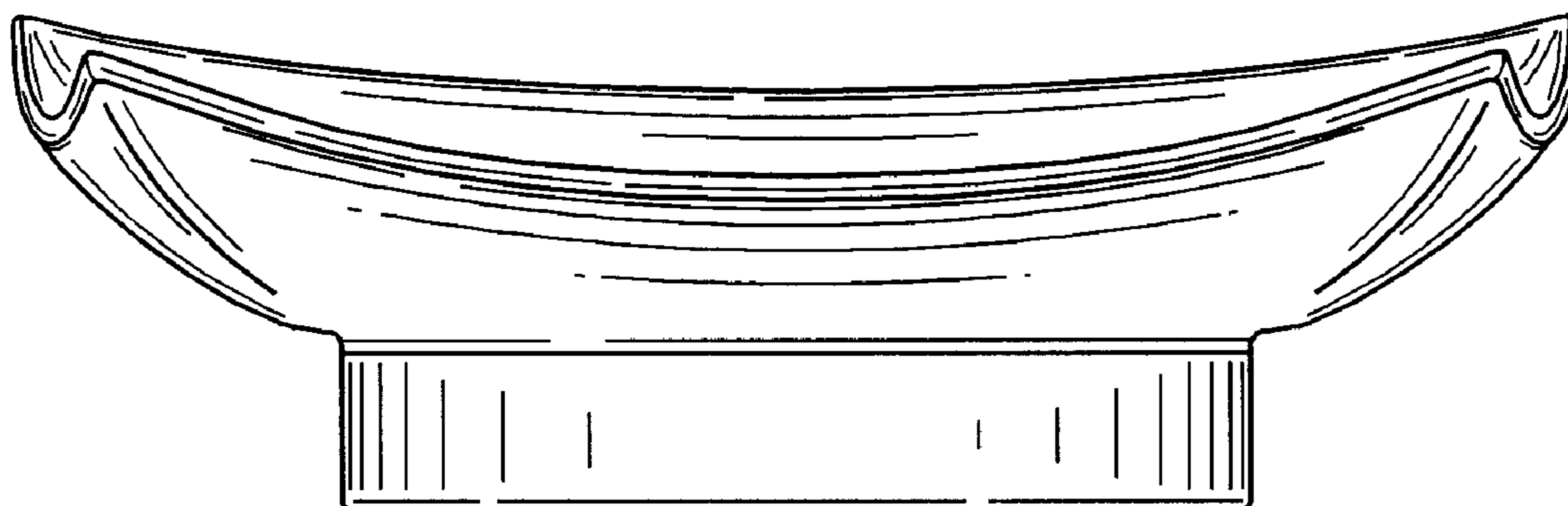

FIG. 9

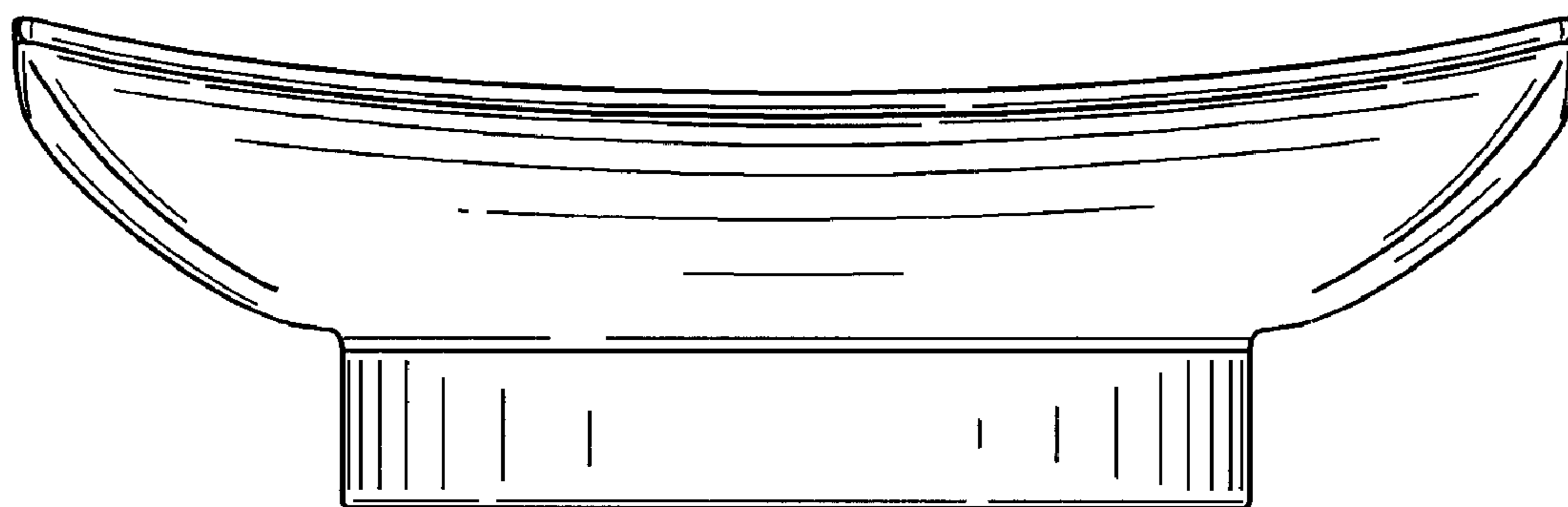

FIG. 10



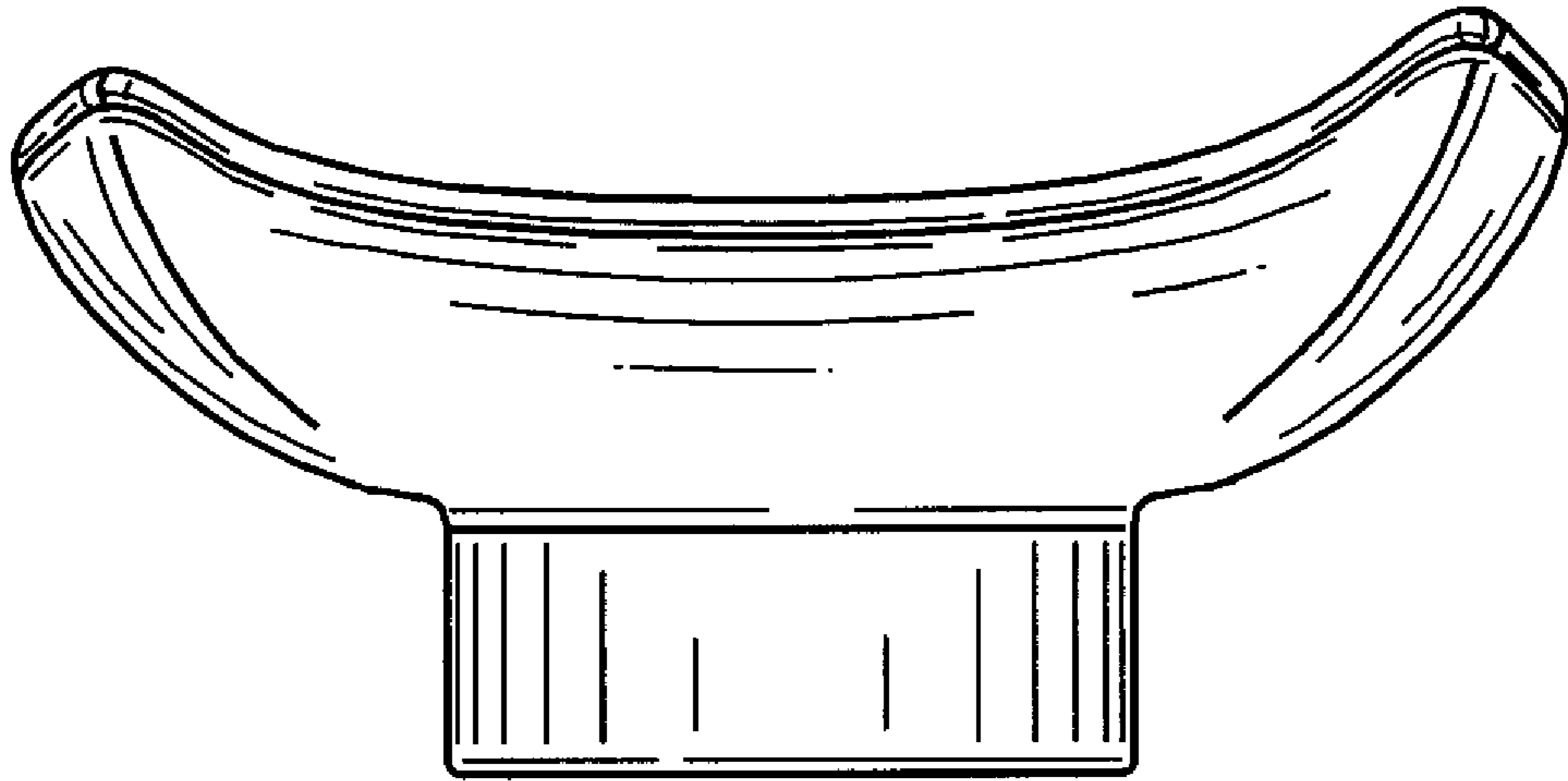

FIG. 11

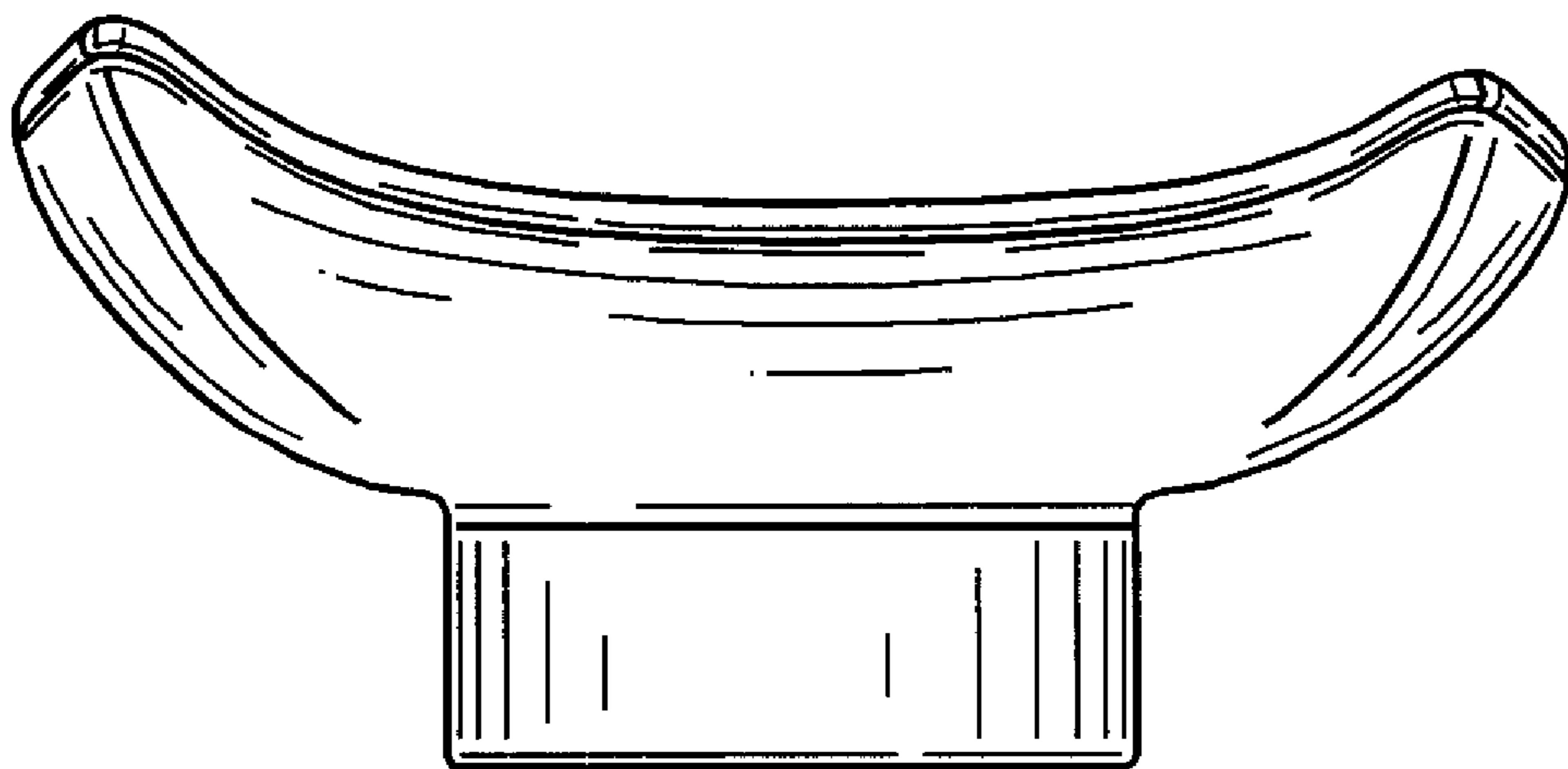

FIG. 12

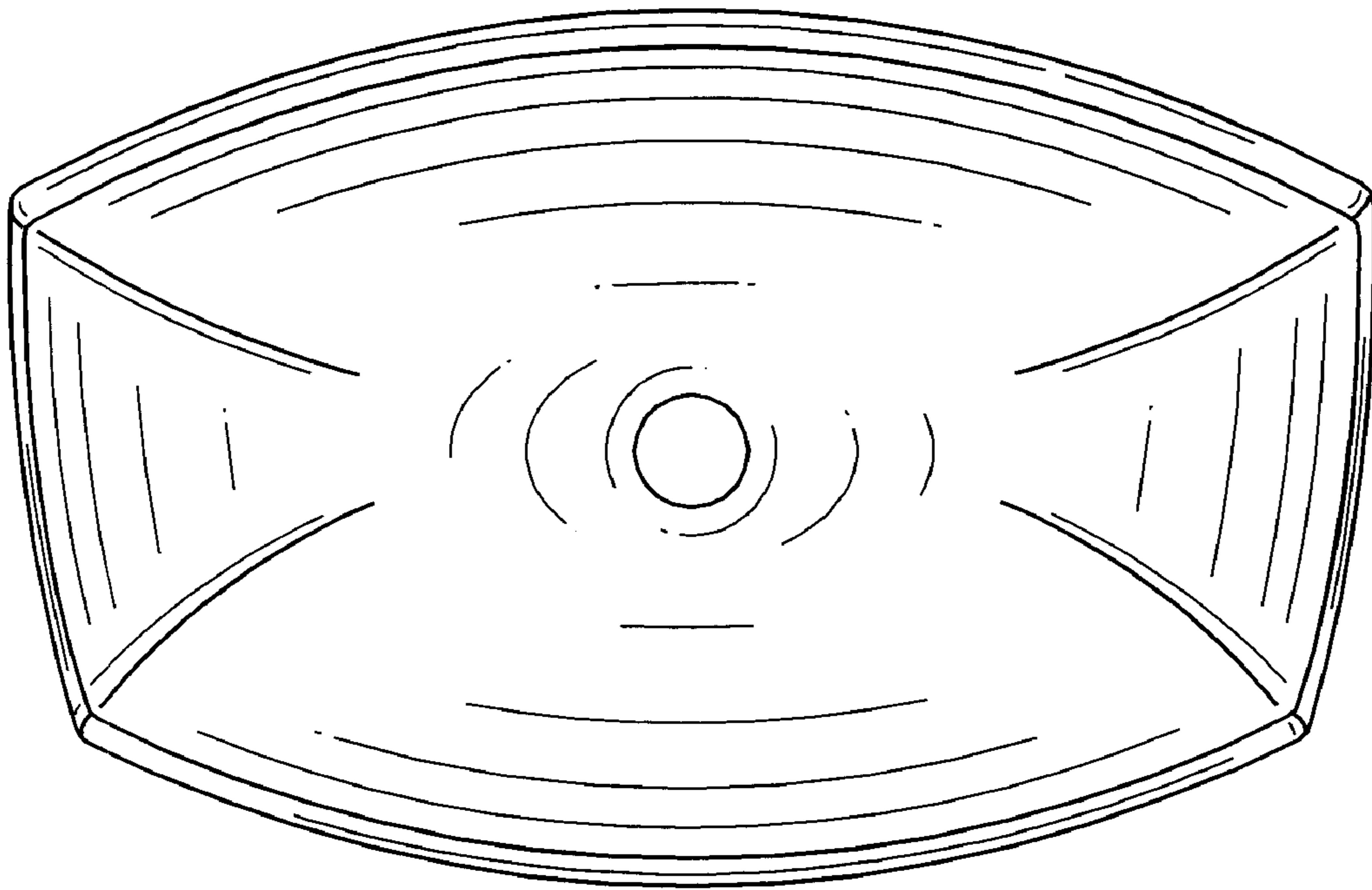

FIG. 13

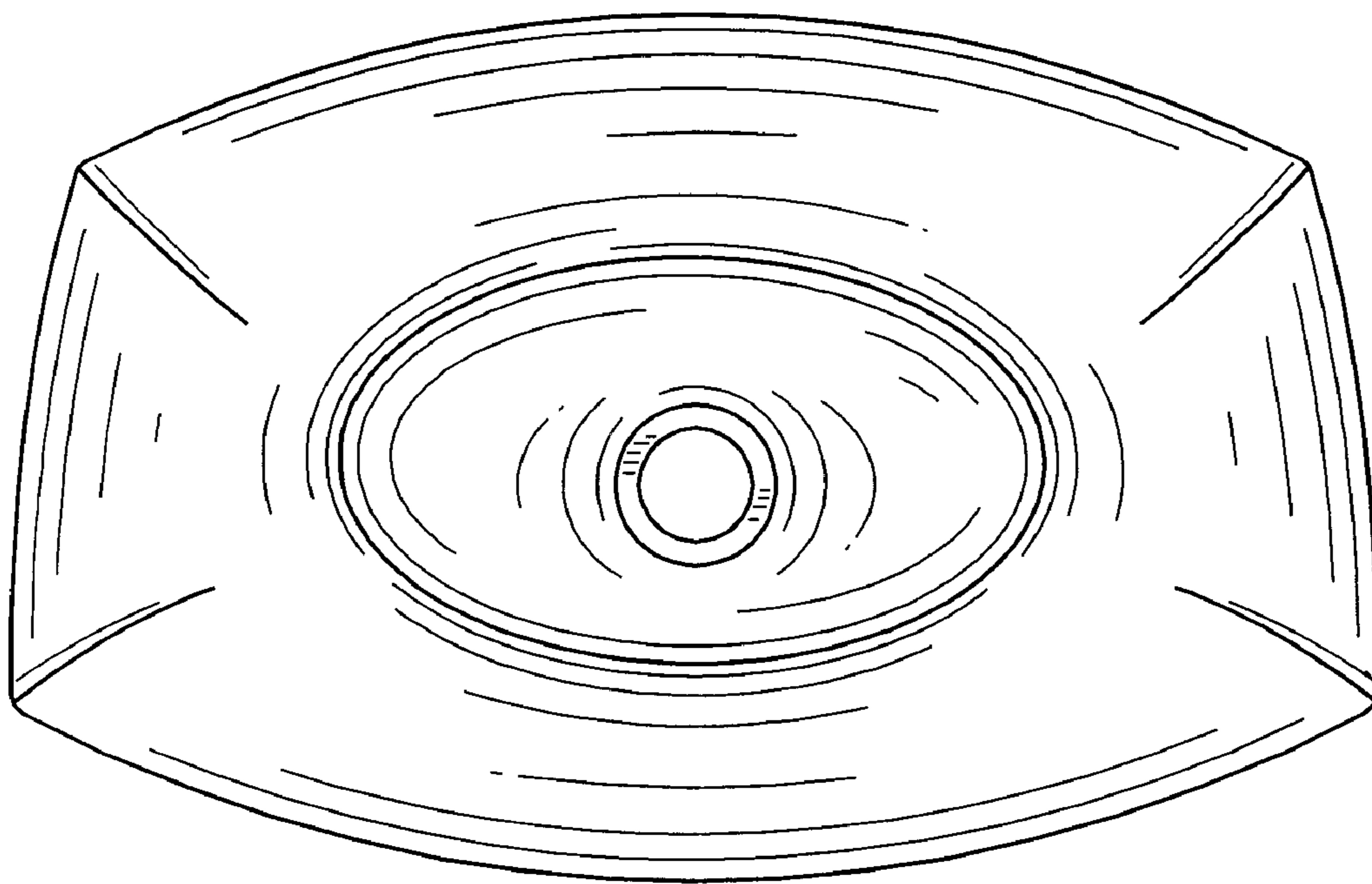

FIG. 14

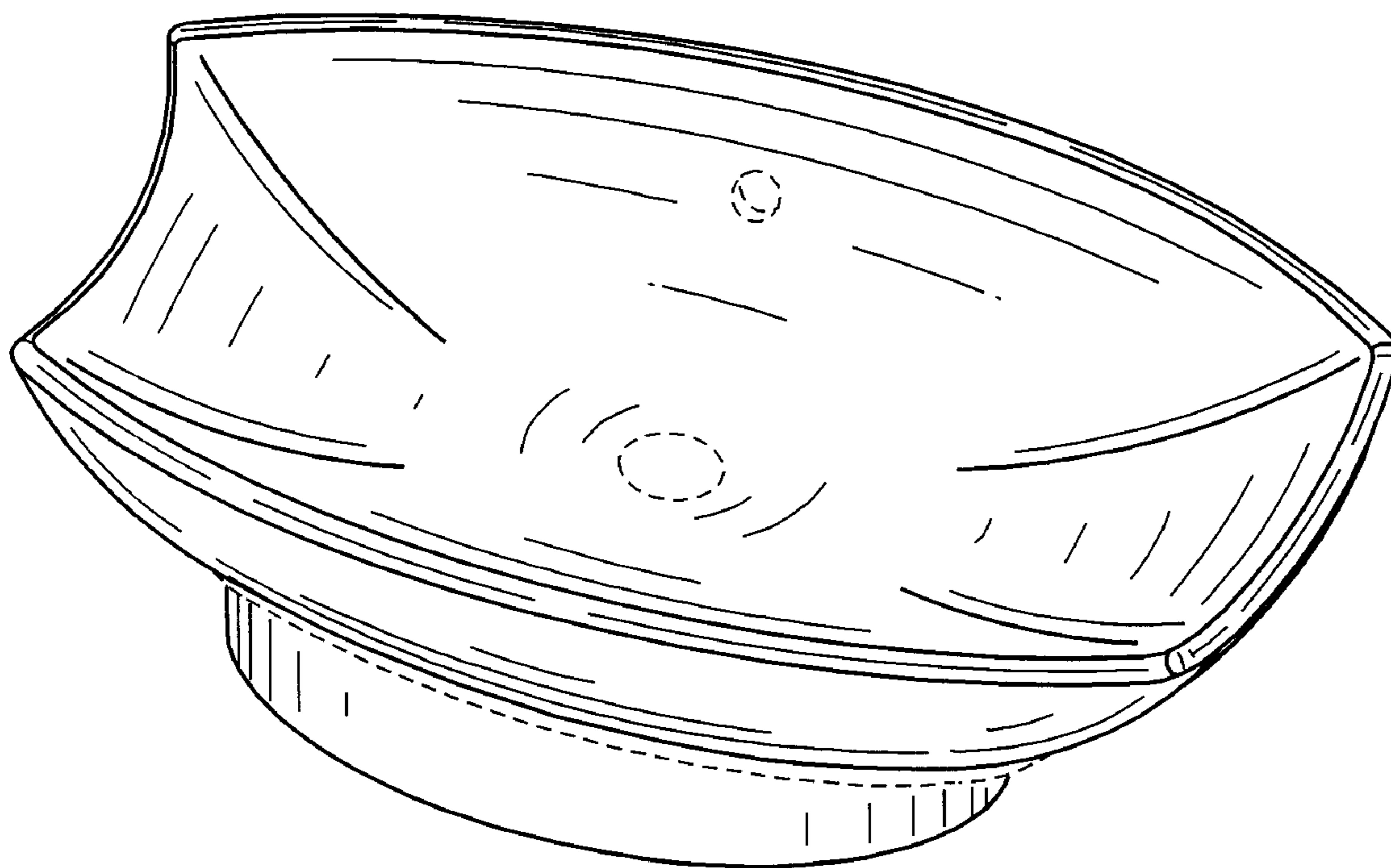

FIG. 15

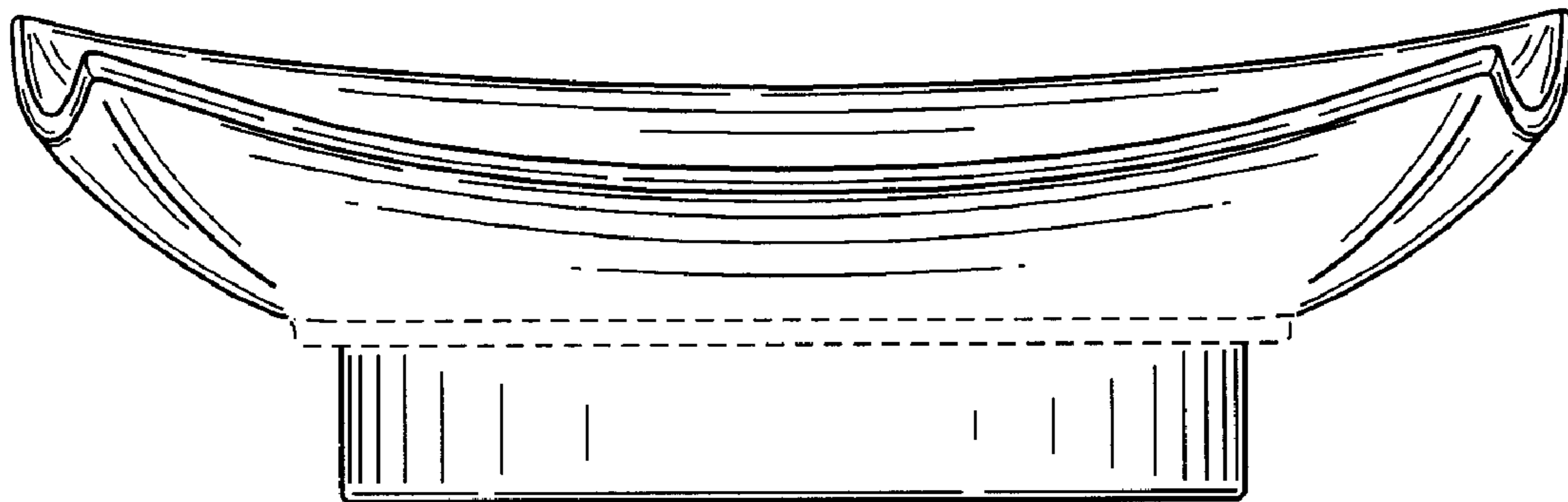

FIG. 16

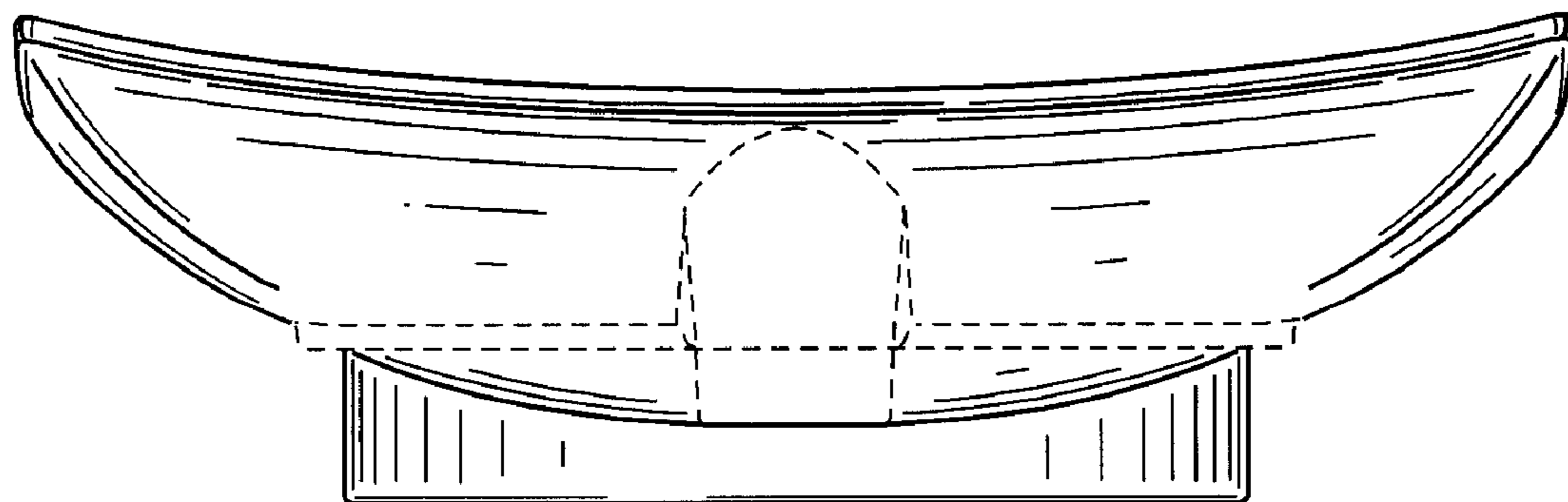

FIG. 17

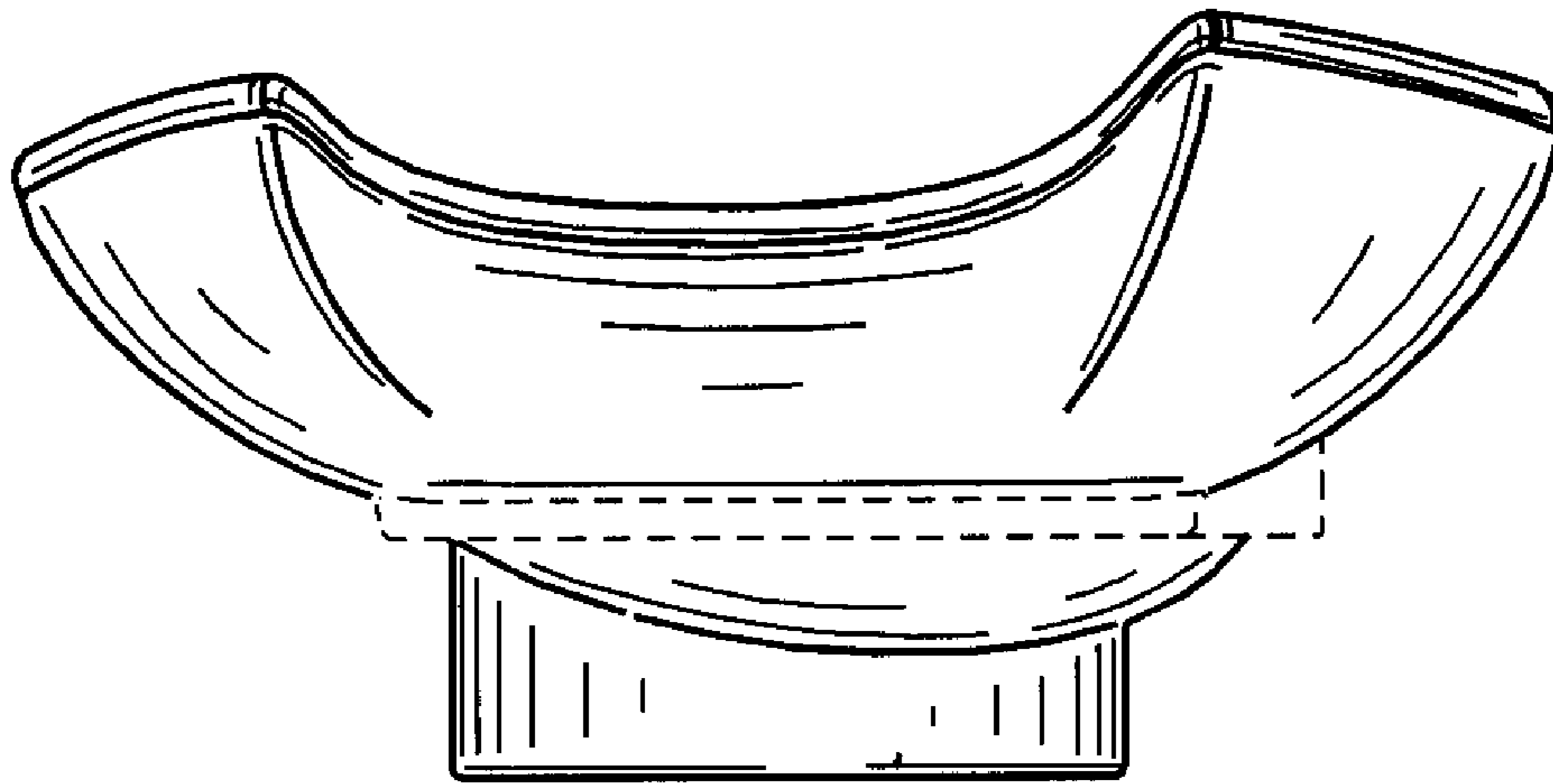

FIG. 18

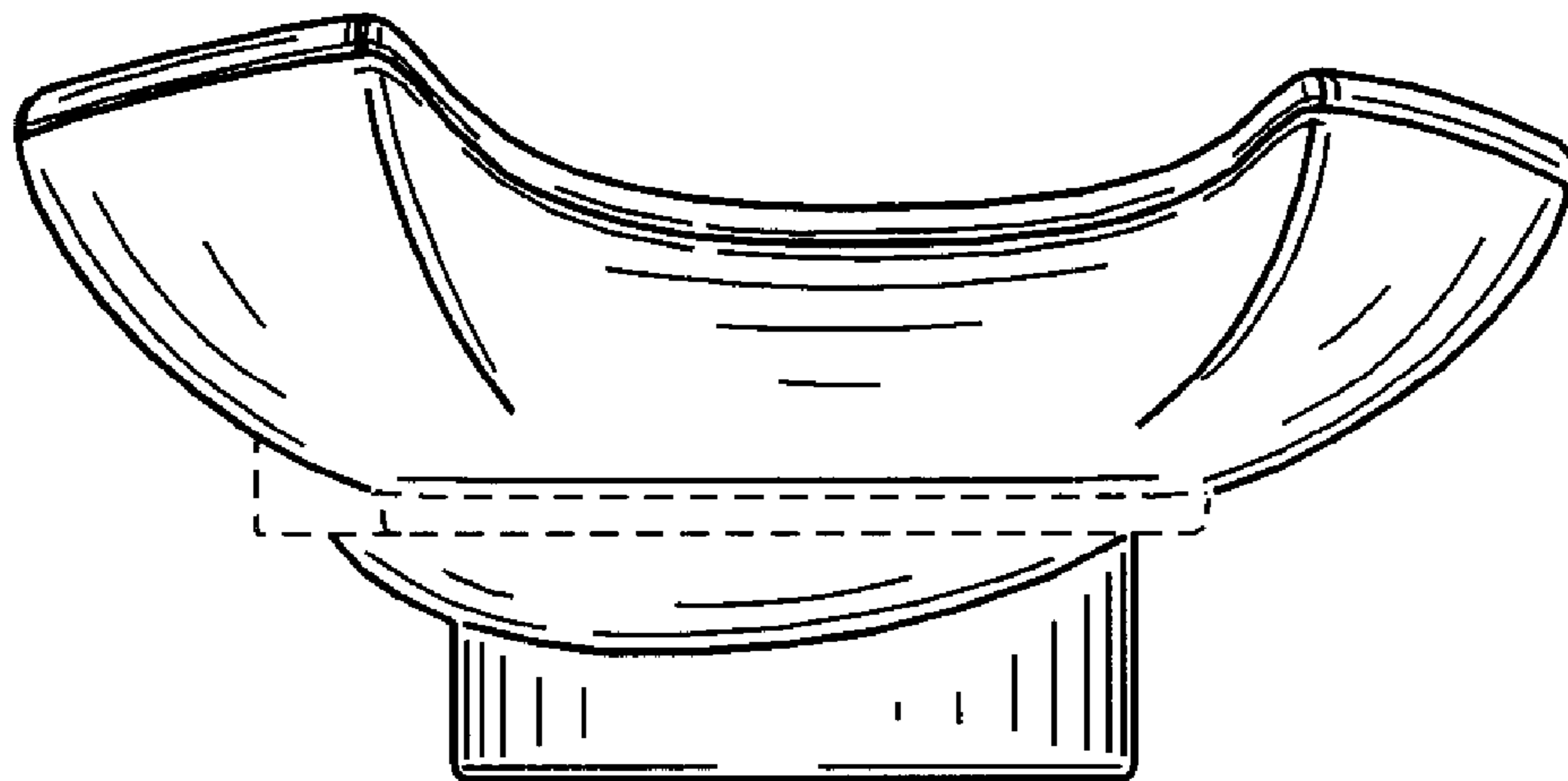

FIG. 19



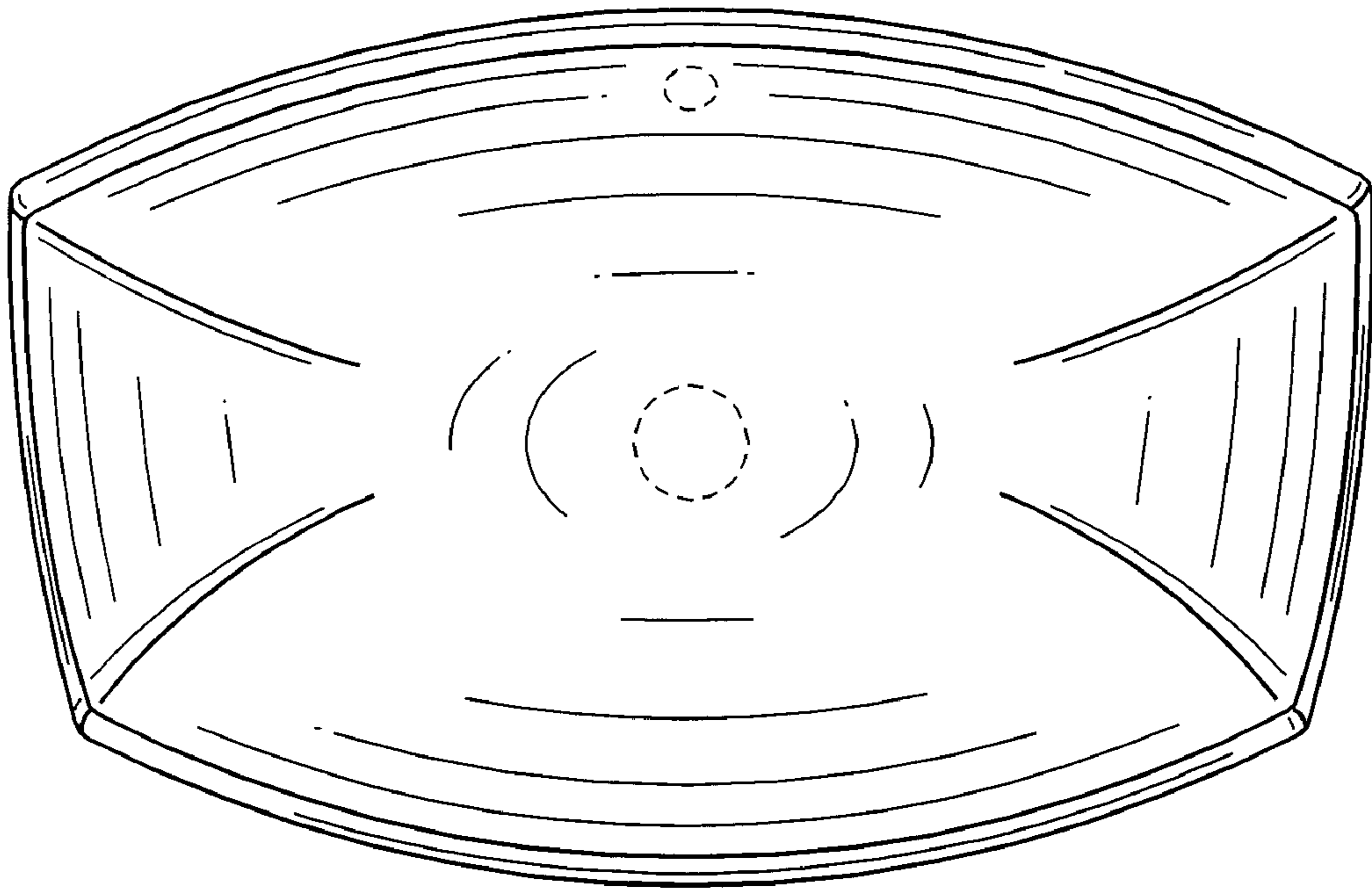

FIG. 20

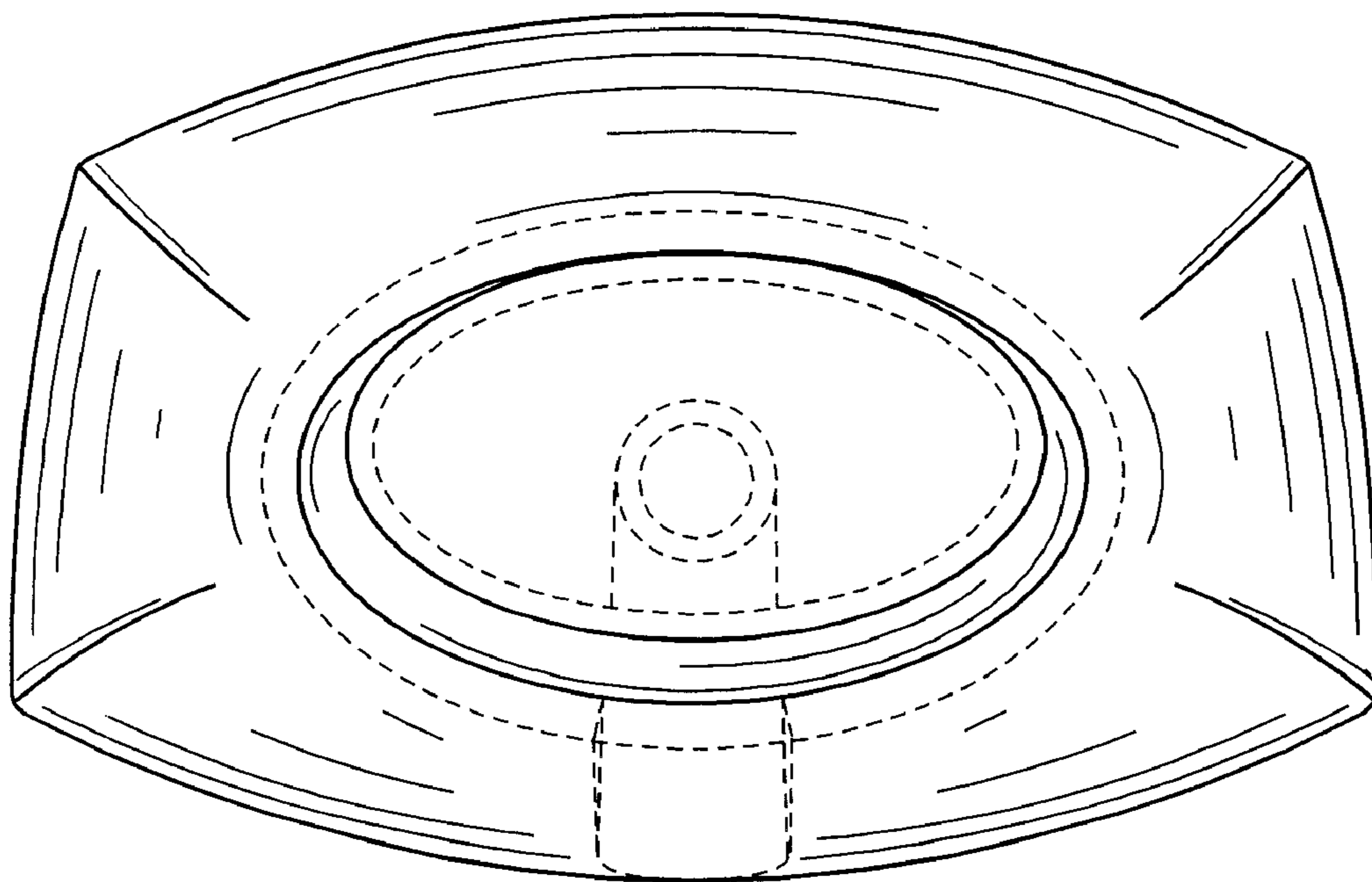

FIG. 21

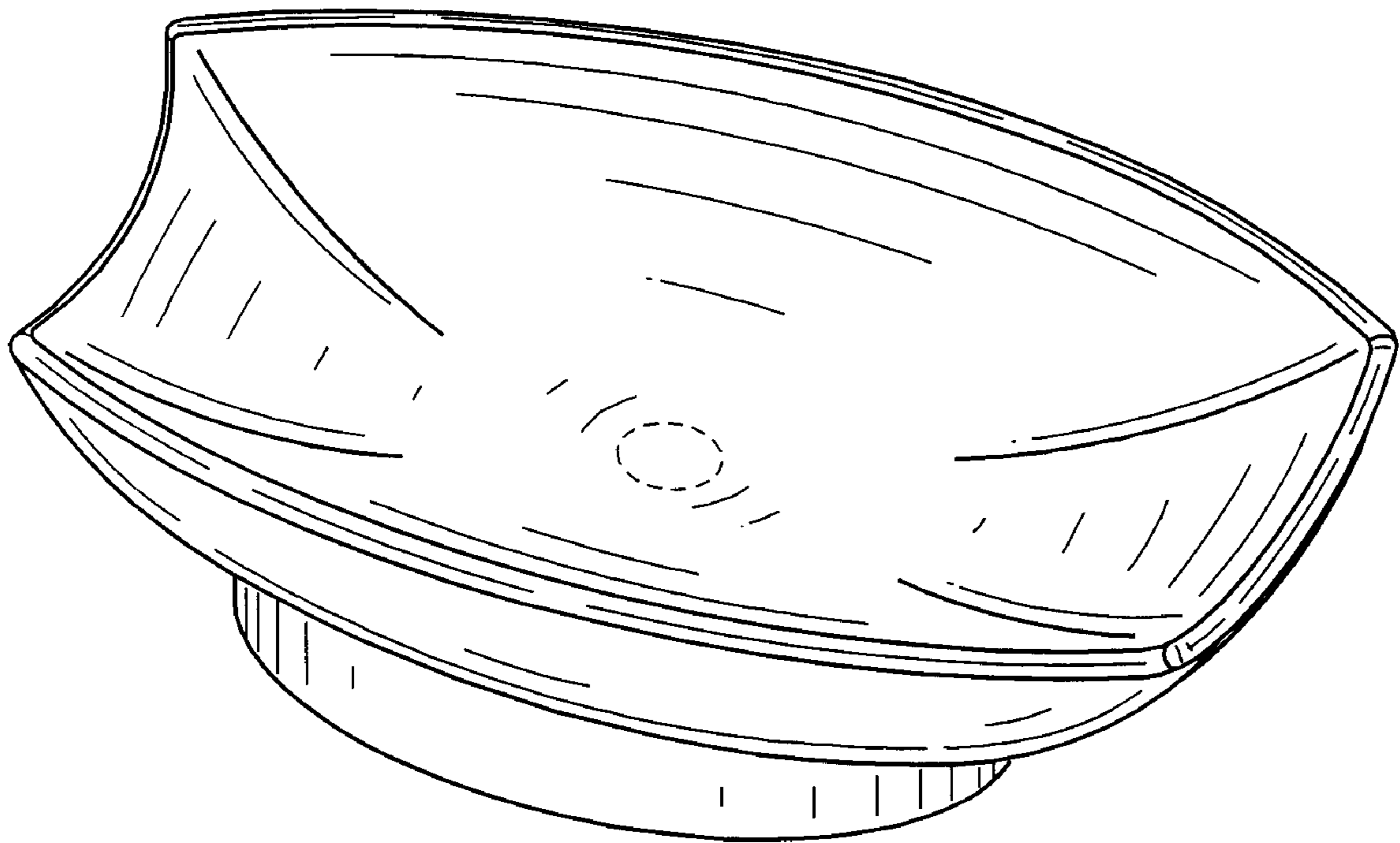

FIG. 22

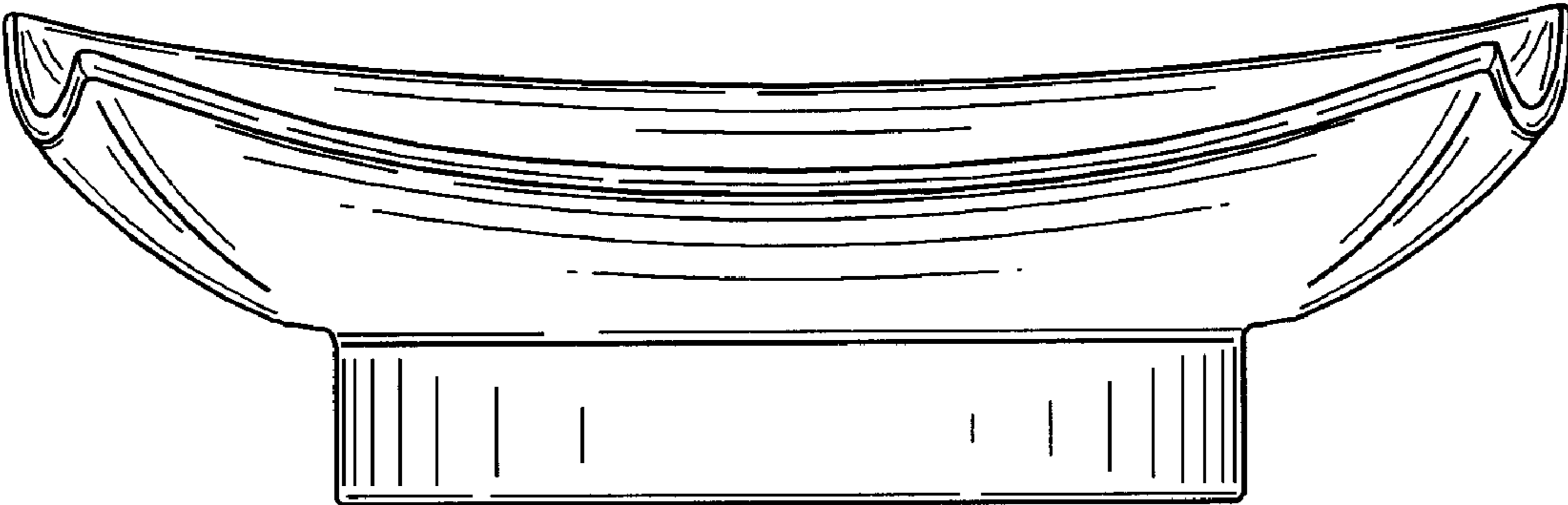

FIG. 23

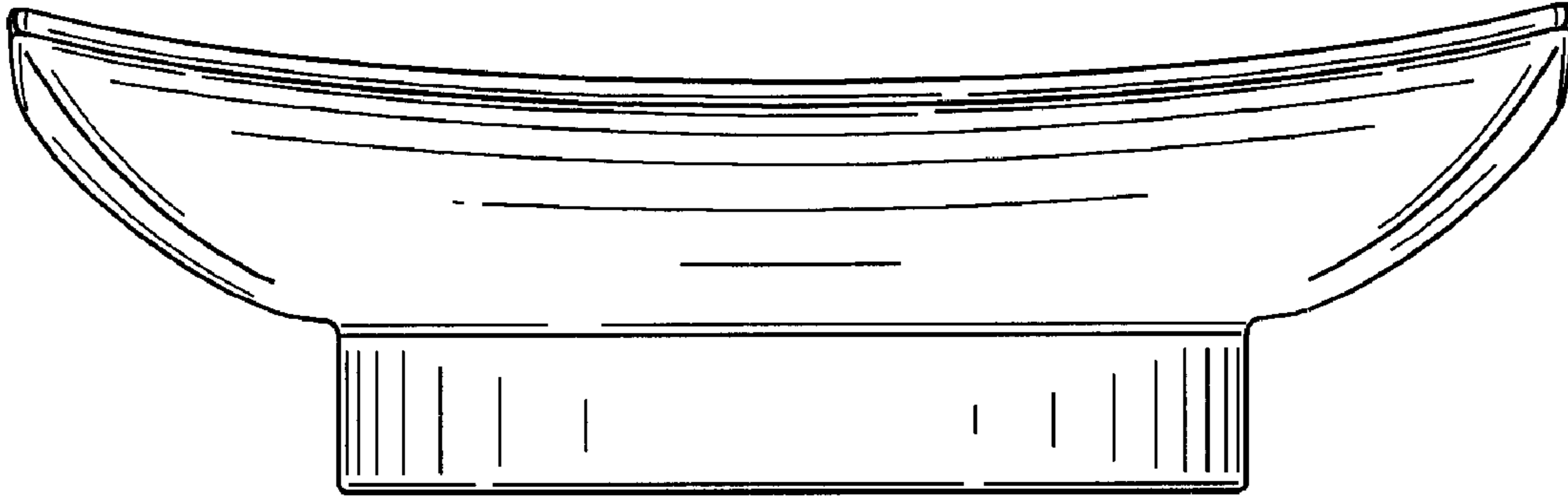

FIG. 24

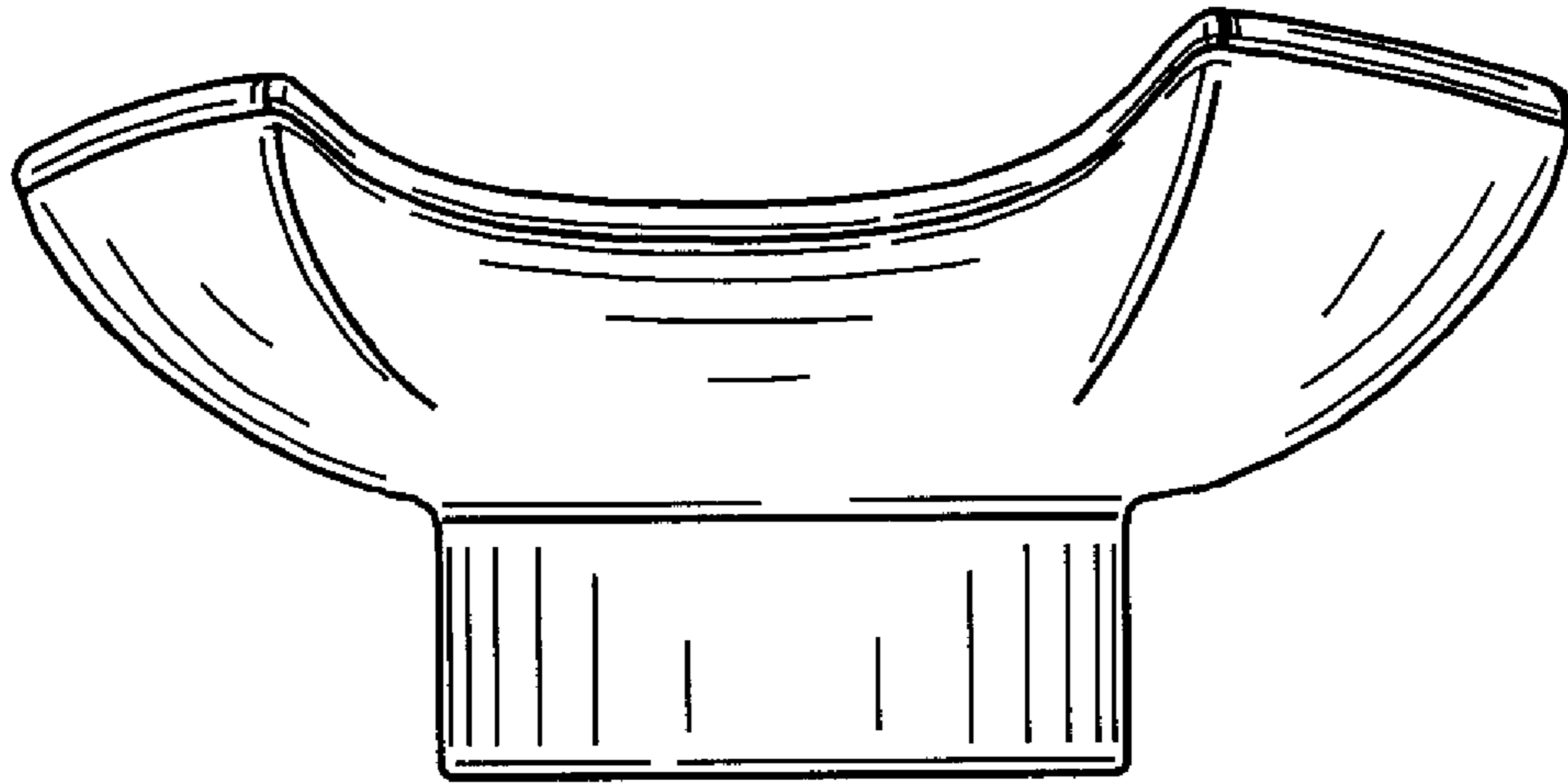

FIG. 25

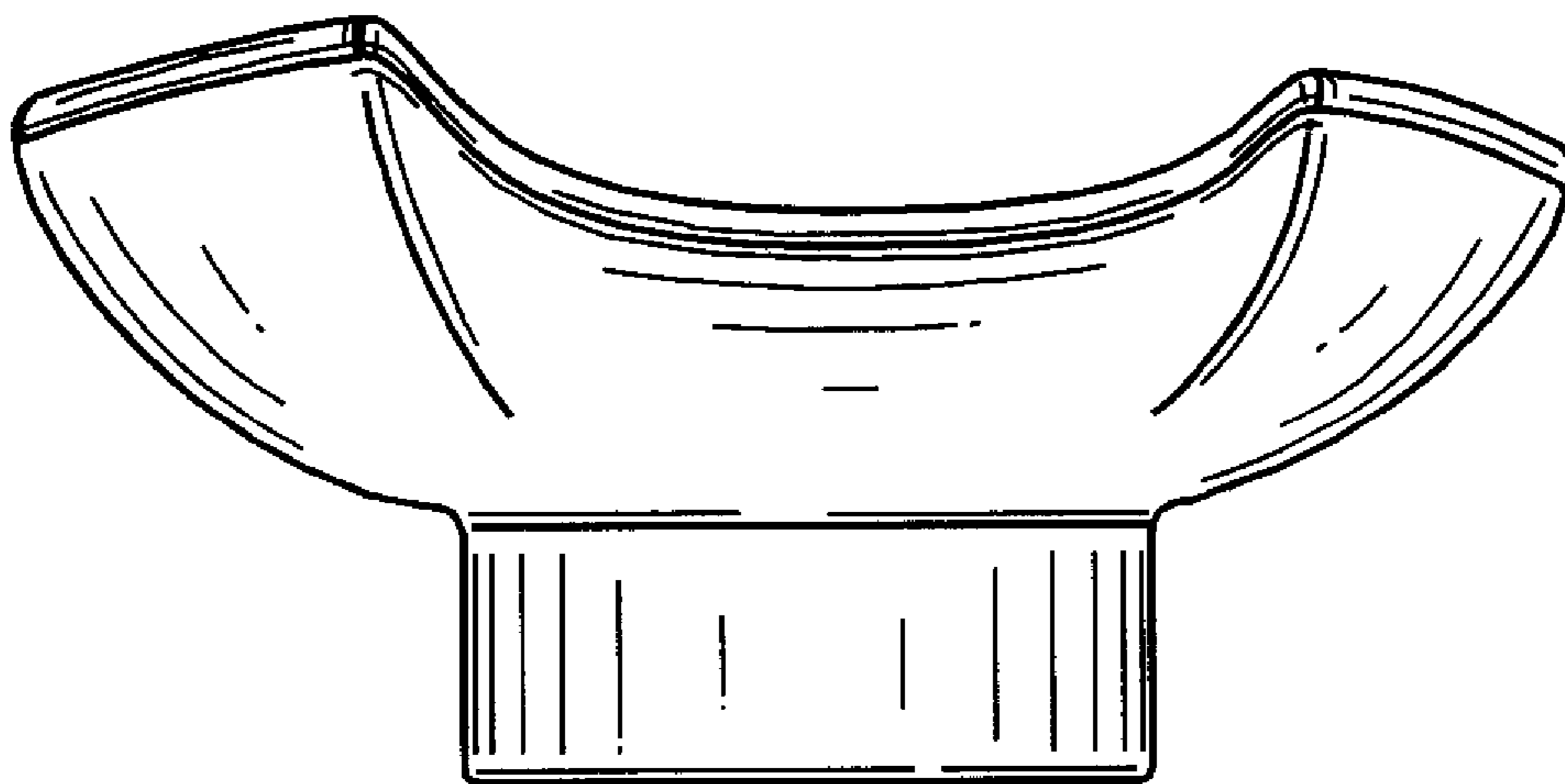

FIG. 26

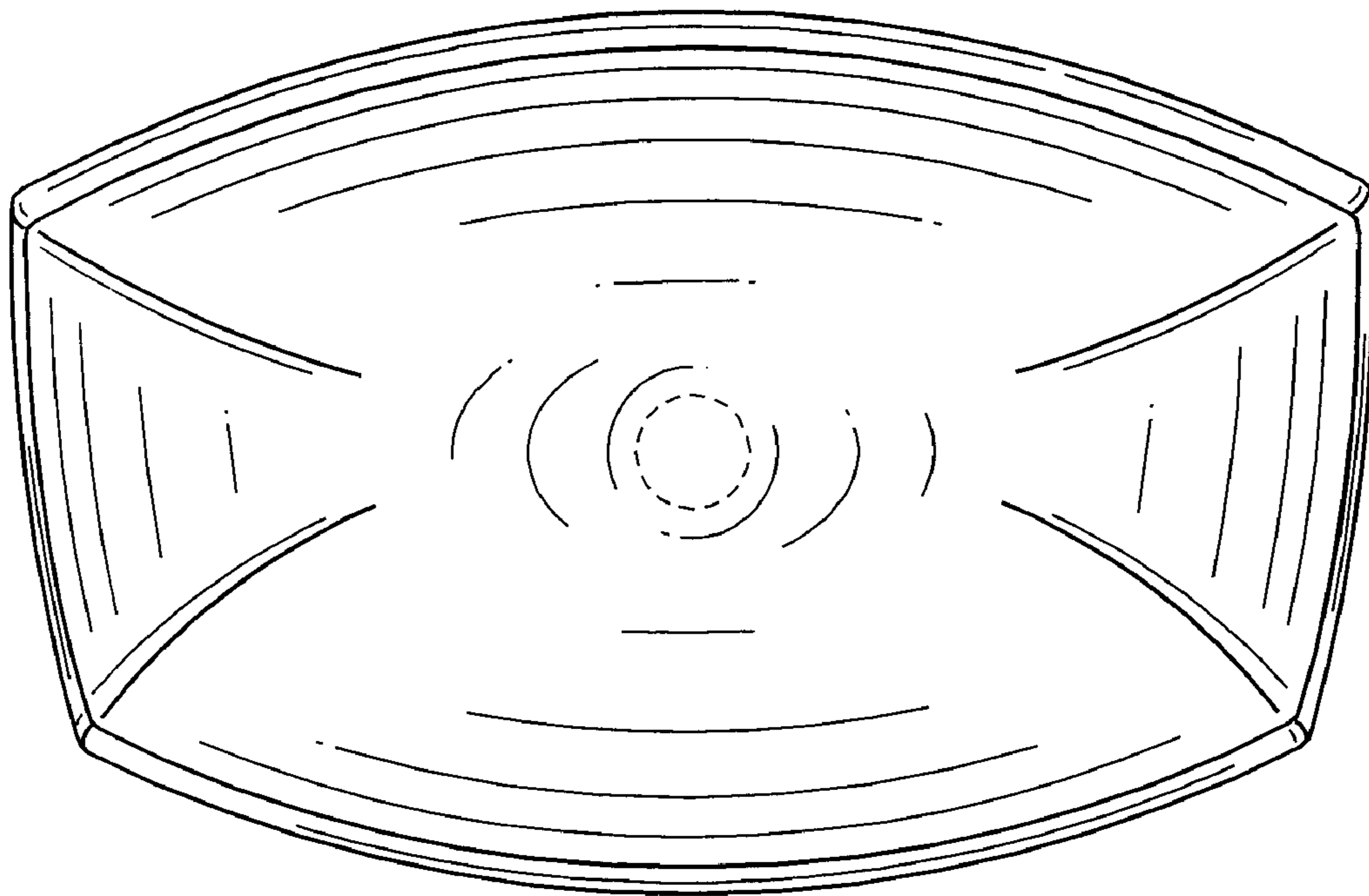

FIG. 27

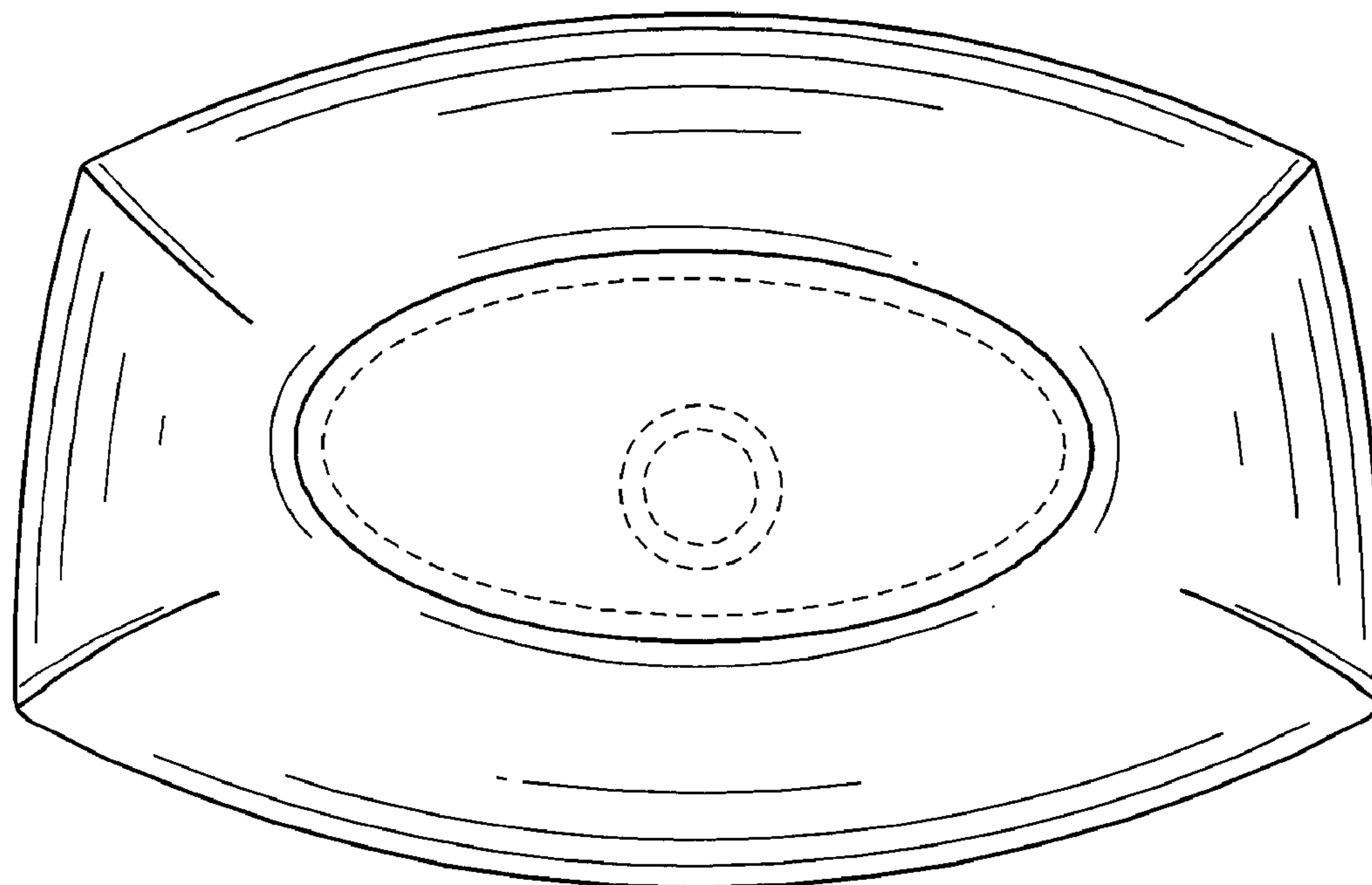

FIG. 28