

US00D563401S

(12) **United States Design Patent**
Tomasso et al.

(10) **Patent No.:** **US D563,401 S**
(45) **Date of Patent:** **** Mar. 4, 2008**

(54) **HANDHELD ELECTRONIC COMMUNICATIONS DEVICE**

D472,551 S 4/2003 Griffin D14/346
D478,585 S 8/2003 Griffin D14/346
D478,882 S * 8/2003 Peng et al. D14/138

(75) Inventors: **Keir Tomasso**, Sewell, NJ (US);
Joseph E. D'Ottavi, Haddon Township,
NJ (US)

(Continued)

(73) Assignee: **L-3 Communications Corporation**,
New York, NY (US)

OTHER PUBLICATIONS

HP iPAQ h6315, announced 4Q 2004, <URL:www.gsmarena.com>,
retrieved from internet Sep. 17, 2007.*

(**) Term: **14 Years**

(Continued)

(21) Appl. No.: **29/279,068**

Primary Examiner—Ian Simmons

Assistant Examiner—Carla Jobe Wright

(22) Filed: **Apr. 19, 2007**

(74) *Attorney, Agent, or Firm*—Woodcock Washburn LLP

(51) **LOC (8) Cl.** **14-03**

(52) **U.S. Cl.** **D14/248**; D14/138; D14/346

(58) **Field of Classification Search** D14/137–138,
D14/147–148, 156, 218, 247–248, 341–347,
D14/496; D16/208; D21/329, 331, 333,
D21/517; 348/14.01–14.02; 361/814; 379/
433.01–433.13; 455/90.3, 556.1–556.2,
455/566, 575.1, 575.3, 575.4

See application file for complete search history.

(57) **CLAIM**

We claim the ornamental design for a handheld electronic communications device, as shown and described.

(56) **References Cited**

DESCRIPTION

U.S. PATENT DOCUMENTS

D416,256 S	11/1999	Griffin et al.	D14/191
D432,511 S *	10/2000	Eckholm	D14/138
D433,460 S	11/2000	Griffin et al.	D21/329
6,278,442 B1	8/2001	Griffin et al.	345/169
D454,349 S *	3/2002	Makidera et al.	D14/343
6,396,482 B1	5/2002	Griffin et al.	345/169
D459,323 S *	6/2002	Jeong	D14/138
D459,710 S *	7/2002	Jeong	D14/138
D460,493 S	7/2002	Griffin et al.	D21/329
D461,803 S	8/2002	Griffin et al.	D14/346
D462,958 S	9/2002	Nguyen et al.	D14/343
D463,422 S	9/2002	Webb	D14/343
D463,423 S	9/2002	Webb	D14/343
6,452,588 B2	9/2002	Griffin et al.	345/169
D464,995 S	10/2002	Griffin et al.	D21/329
6,489,950 B1	12/2002	Griffin et al.	345/168
D472,225 S	3/2003	Griffin	D14/138

The subject matter disclosed and claimed herein is related to the subject matter disclosed and claimed in U.S. patent application Ser. No. 29/279,069, filed on Apr. 19, 2007, the disclosure of which is incorporated herein by reference.

FIG. 1 is a rear perspective view of a handheld electronic communications device showing our new design.

FIG. 2 is a front perspective view thereof.

FIG. 3 is a left side view thereof.

FIG. 4 is a front view thereof.

FIG. 5 is a right side view thereof.

FIG. 6 is a rear view thereof.

FIG. 7 is a bottom view thereof; and,

FIG. 8 is a top view thereof.

The broken line showing of environmental structures is for illustrative purposes only and forms no part of the claimed design.

1 Claim, 3 Drawing Sheets

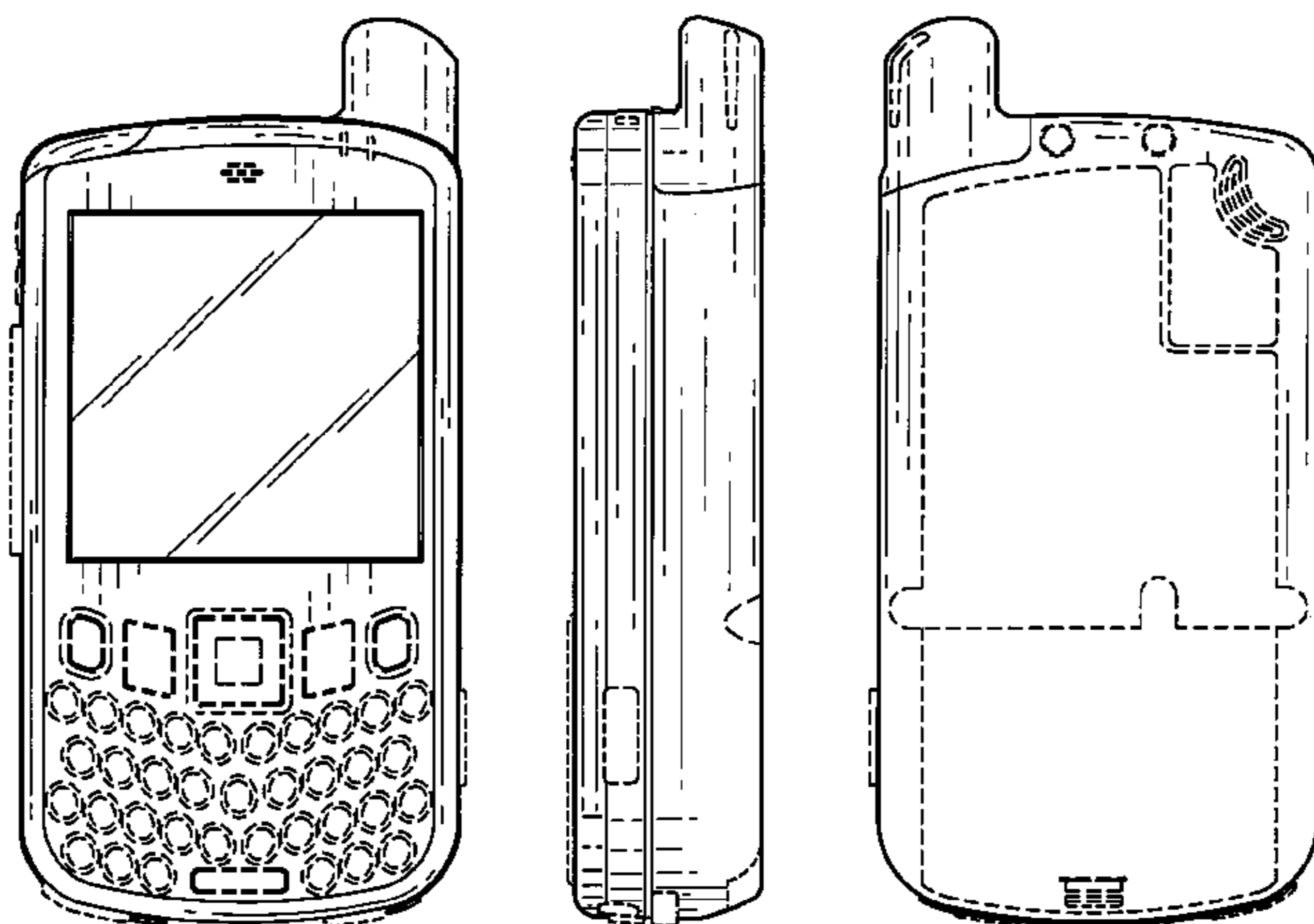

US D563,401 S

Page 2

U.S. PATENT DOCUMENTS

6,611,254	B1	8/2003	Griffin et al.	345/169	7,133,707	B1	11/2006	Rak et al.	455/575.1
6,611,255	B2	8/2003	Griffin et al.	345/169	7,153,049	B2	12/2006	Pletikosa	400/472
D479,233	S	9/2003	Griffin	D14/346	D537,082	S	2/2007	Griffin	D14/455
D487,734	S *	3/2004	Peng et al.	D14/138	D541,288	S	4/2007	Lam et al.	D14/455
D490,076	S	5/2004	Griffin	D14/346	2006/0033704	A1	2/2006	Ladouceur et al.	345/156
D490,119	S	5/2004	Griffin et al.	D21/329	2006/0176279	A1	8/2006	Bersenev et al.	345/169
D496,637	S *	9/2004	Miyazawa et al.	D14/138	2006/0258326	A1 *	11/2006	Webb	455/350
D496,642	S *	9/2004	Harries et al.	D14/138	2006/0264232	A1	11/2006	Fyke et al.	455/550.1
D497,907	S	11/2004	Griffin	D14/346	2006/0264237	A1	11/2006	Rose et al.	455/557
D501,456	S *	2/2005	Miyazawa et al.	D14/138	2007/0046638	A1	3/2007	Bumiller	345/169
D502,159	S *	2/2005	Chan et al.	D14/138					
6,867,763	B2	3/2005	Griffin et al.	345/168					
6,873,317	B1	3/2005	Griffin et al.	345/168					
6,891,529	B2	5/2005	Ladouceur et al.	345/169					
D514,571	S	2/2006	Hawkins et al.	D14/391					
D515,093	S	2/2006	Hawkins et al.	D14/392					
D518,820	S	4/2006	Hawkins et al.	D14/346					
D518,821	S	4/2006	Hawkins et al.	D14/346					
D518,825	S	4/2006	Hawkins et al.	D14/392					
D519,502	S	4/2006	Hawkins et al.	D14/346					
D524,275	S *	7/2006	Shin	D14/138					
D525,263	S	7/2006	Hawkins et al.	D14/456					
7,073,964	B2	7/2006	Griffin et al.	400/486					
D525,970	S	8/2006	Rak et al.	D14/346					
D526,985	S *	8/2006	Neher et al.	D14/138					
7,103,432	B2	9/2006	Drader et al.	700/95					
7,113,111	B2	9/2006	Tyneski et al.	341/20					

OTHER PUBLICATIONS

HP iPAQ h6515, announced 2Q 2005, <URL:www.gsmarena.com>, retrieved from internet Sep. 17, 2007.*
O2 Cosmo, announced Sep. 2006, <URL:www.gsmarena.com>, retrieved from internet Sep. 17, 2007.*
Palm Treo 600, announced 4Q 2003, <URL:www.gsmarena.com>, retrieved from internet Sep. 17, 2007.*
Motorola Q 9h, announced Feb. 2007, <URL:www.gsmarena.com>, retrieved from internet Sep. 17, 2007.*
Palm Treo 500v, announced Sep. 2007, <URL:www.gsmarena.com>, retrieved from internet Sep. 17, 2007.*
Amoi E78, announced 2007, <URL:www.gsmarena.com>, retrieved from internet Sep. 17, 2007.*
BenQ-Siemens P51, announced Mar. 2006, <URL:www.gsmarena.com>, retrieved from internet Sep. 17, 2007.*

* cited by examiner

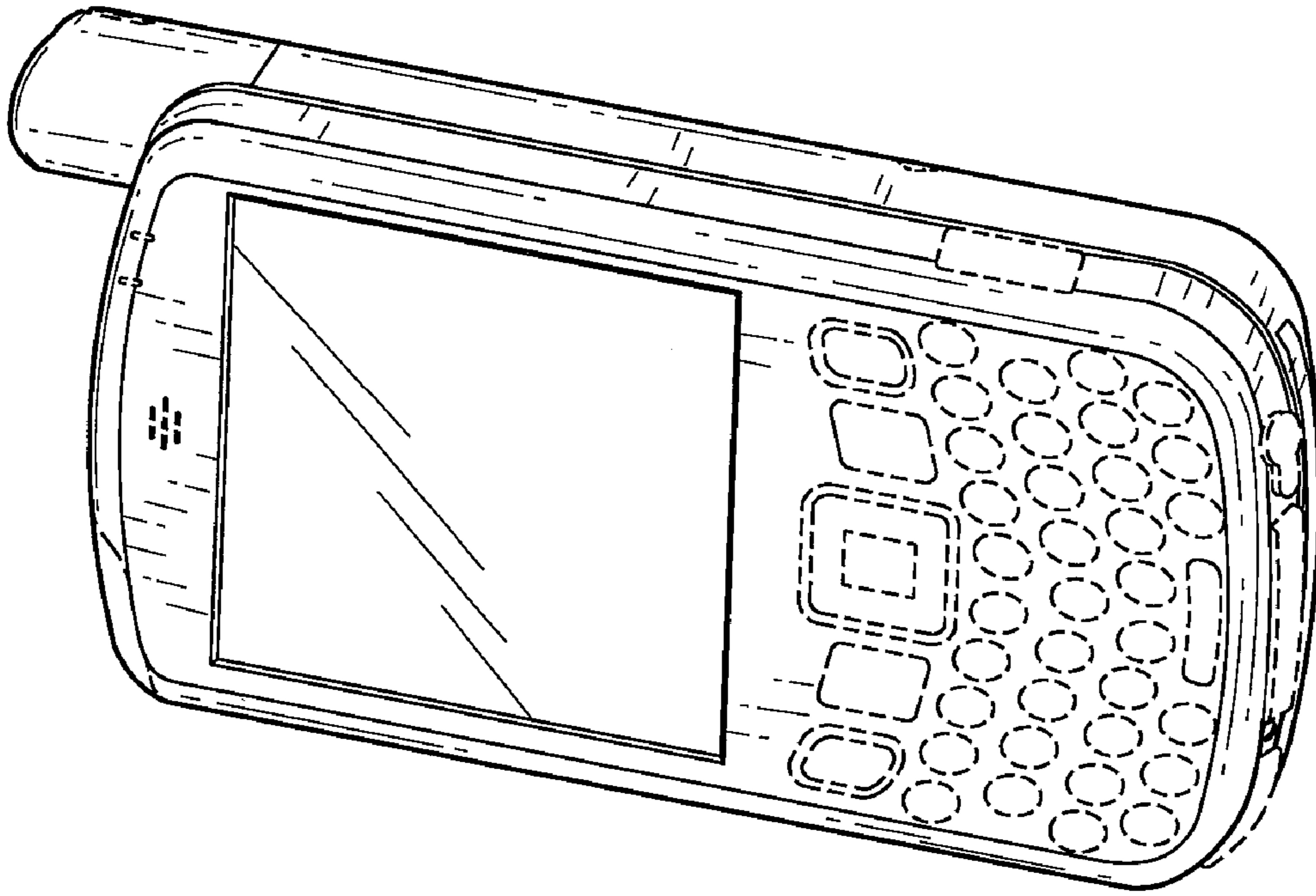

FIG. 2

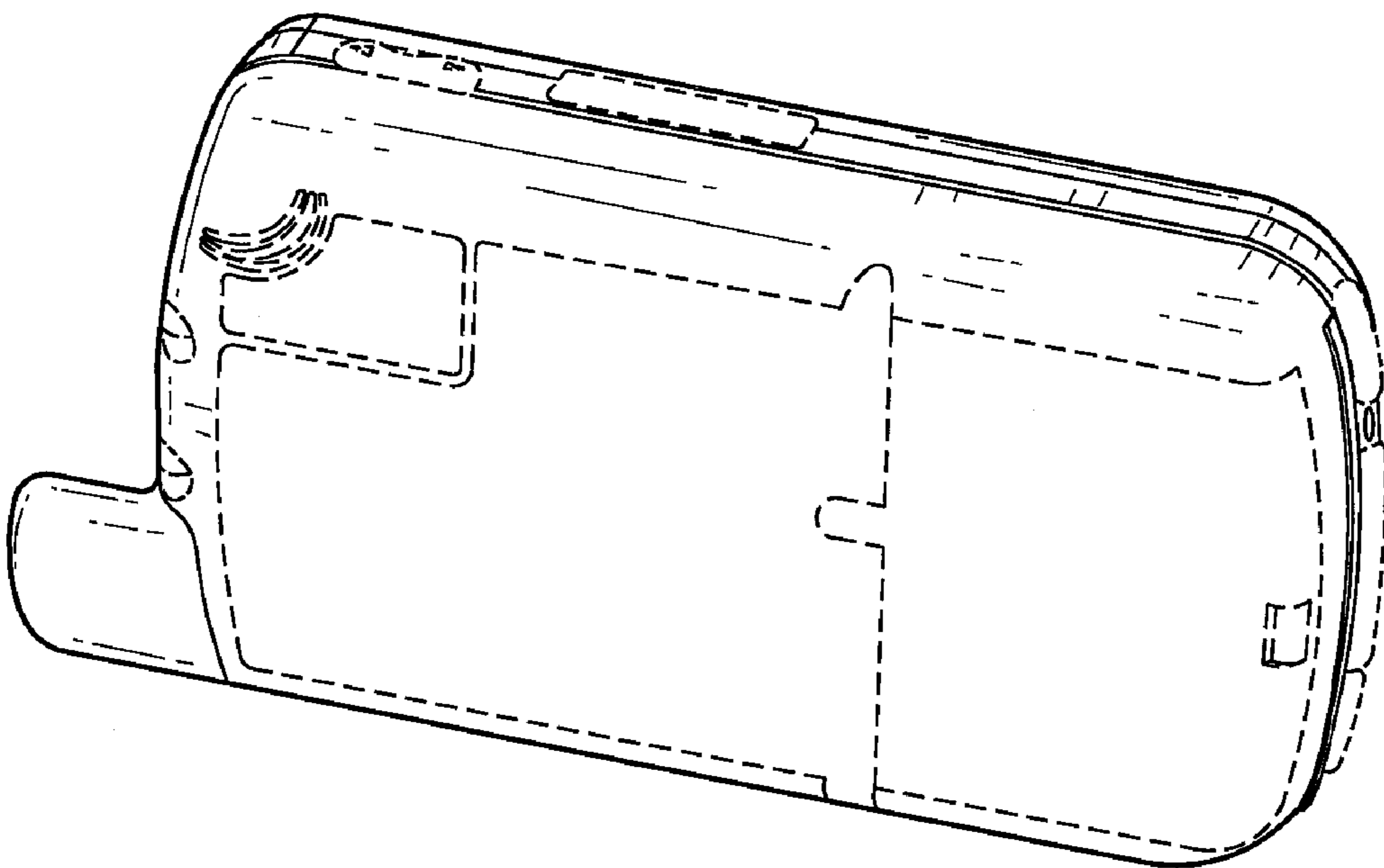

FIG. 1

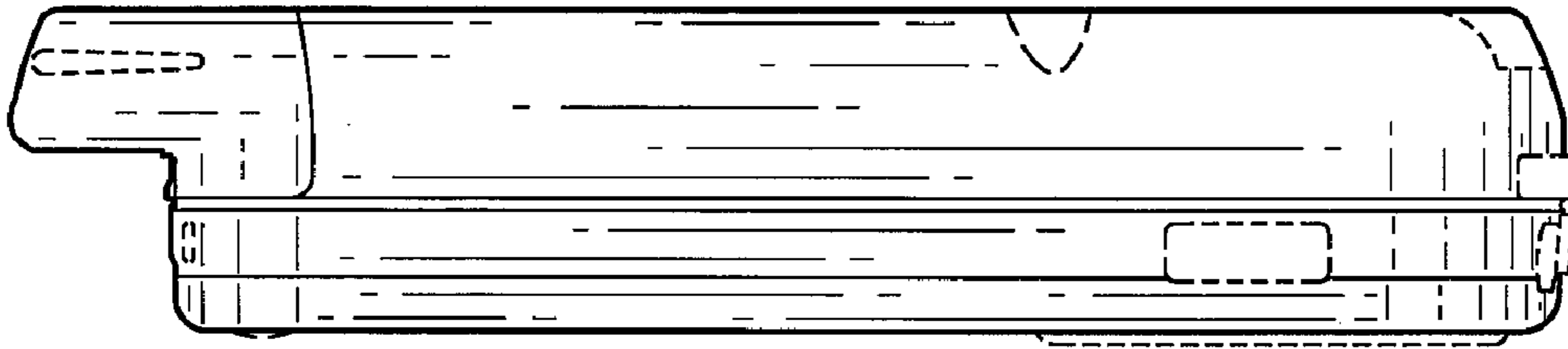

FIG. 5

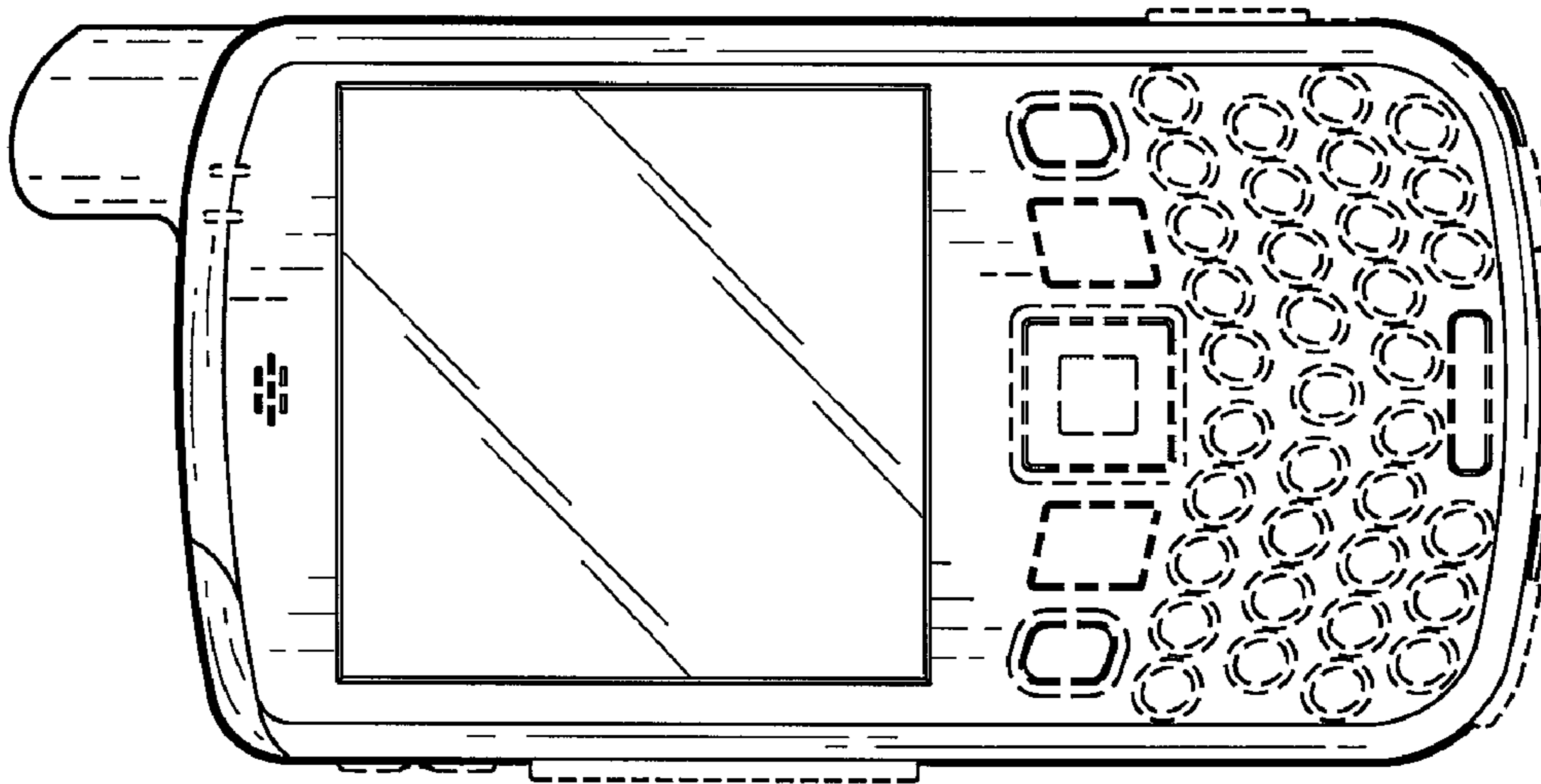

FIG. 4

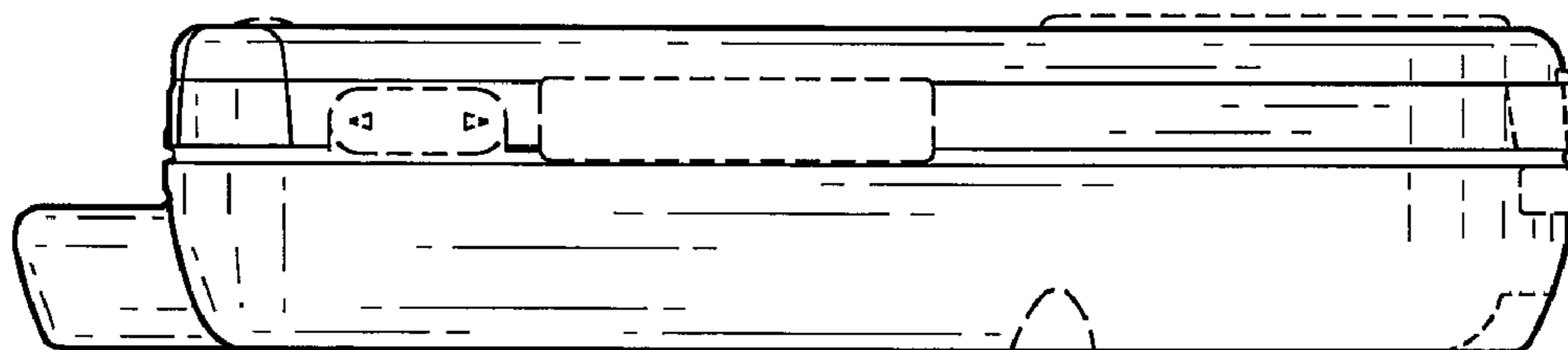

FIG. 3

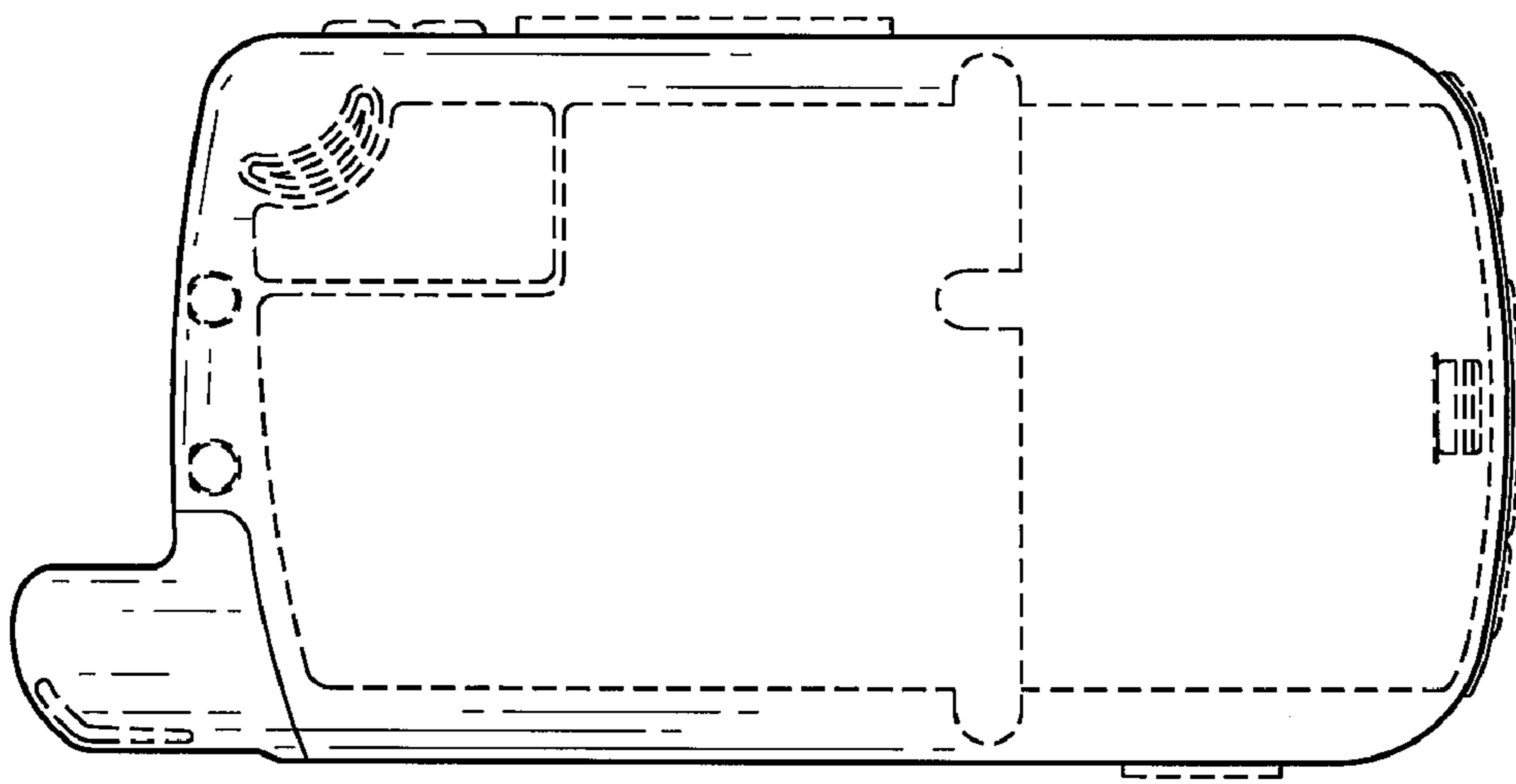

FIG. 6

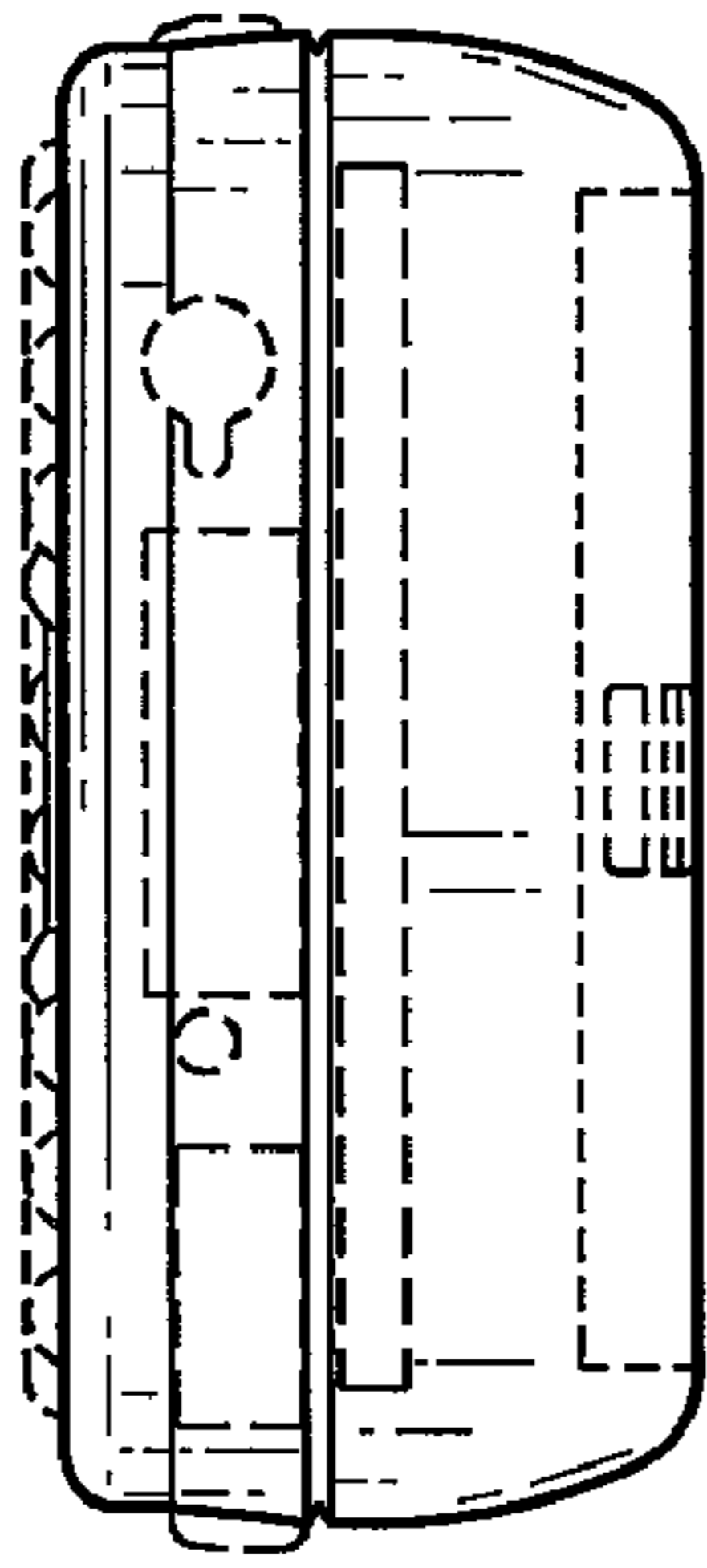

FIG. 7

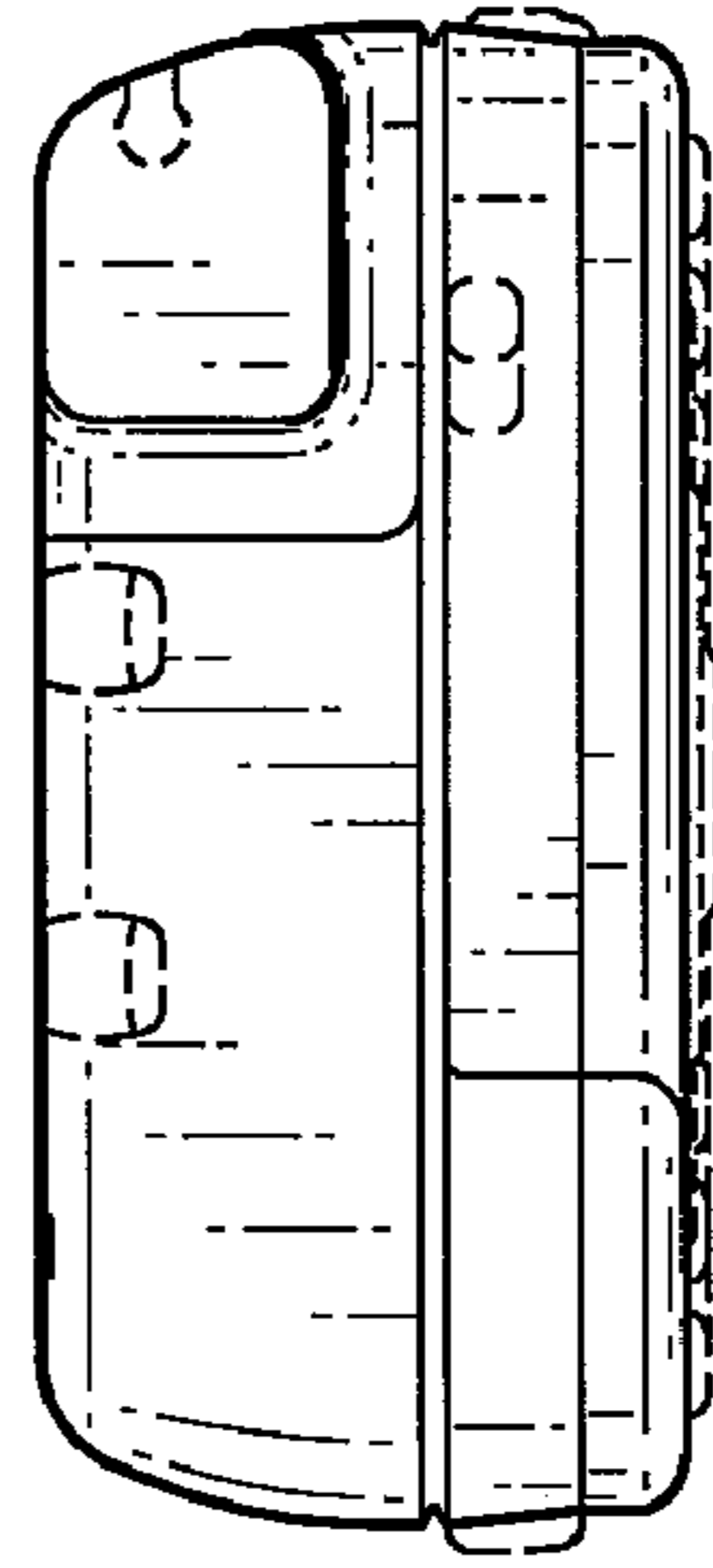

FIG. 8