

US00D563373S

(12) **United States Design Patent**
Suk et al.

(10) **Patent No.:** **US D563,373 S**
(45) **Date of Patent:** **** Mar. 4, 2008**

(54) **MOBILE PHONE**

(75) Inventors: **Chang-Hoon Suk**, Seoul (KR);
Beom-Ku Han, Seoul (KR);
Chang-Soo Lee, Incheon (KR)

(73) Assignee: **Samsung Electronics Co., Ltd.**,
Suwon-Si (KR)

(**) Term: **14 Years**

(21) Appl. No.: **29/274,396**

(22) Filed: **Apr. 20, 2007**

(30) **Foreign Application Priority Data**

Mar. 16, 2007 (KR) 30-2007-0011498

(51) **LOC (8) Cl.** **14-03**

(52) **U.S. Cl.** **D14/138**

(58) **Field of Classification Search** D14/137,
D14/138, 147, 148, 150, 168, 191, 218, 247-248,
D14/341-347, 496; D10/65; D13/168; D18/7;
455/90.3, 556.1, 556.2, 575.1, 575.3, 575.4;
379/433.01-433.13; 361/814; 348/14.02
See application file for complete search history.

(56) **References Cited**

U.S. PATENT DOCUMENTS

D422,971 S *	4/2000	Leib	D14/346
D511,342 S *	11/2005	Chien	D14/346
D526,300 S *	8/2006	Lee	D14/138
D527,000 S *	8/2006	Hong et al.	D14/346
D528,095 S *	9/2006	Kwon et al.	D14/138
D531,611 S *	11/2006	Kim et al.	D14/138
D534,143 S *	12/2006	Lheem	D14/138
D534,144 S *	12/2006	Chung et al.	D14/138
D534,145 S *	12/2006	Lheem	D14/138
D534,515 S *	1/2007	Kim et al.	D14/138
D534,517 S *	1/2007	Cho et al.	D14/138
D534,518 S *	1/2007	Choi et al.	D14/138
D534,888 S *	1/2007	Kim et al.	D14/138
D534,890 S *	1/2007	Kim	D14/138
D544,459 S *	6/2007	Wang	D14/138

D549,198 S *	8/2007	Kim et al.	D14/138
D549,203 S *	8/2007	Kim et al.	D14/138
D549,204 S *	8/2007	Cho	D14/138
2003/0064688 A1 *	4/2003	Mizuta et al.	455/90
2005/0014538 A1 *	1/2005	Hyun et al.	455/575.4
2006/0025184 A1 *	2/2006	Cho et al.	455/575.4
2006/0172786 A1 *	8/2006	Lo	455/575.3
2007/0082718 A1 *	4/2007	Yoon et al.	455/575.4
2007/0121279 A1 *	5/2007	Robertson et al.	361/679
2007/0123179 A1 *	5/2007	Lim	455/90.3

OTHER PUBLICATIONS

LG KU580, announced Apr. 2007, [online], [retrieved on May 18, 2007]. Retrieved from Internet ,<URL: http://www.gsmarena.com>.*

(Continued)

Primary Examiner—Jeffrey Asch
Assistant Examiner—Bridget L Eland
(74) *Attorney, Agent, or Firm*—Staas & Halsey LLP

(57) **CLAIM**

The ornamental design for a mobile phone, as shown and described.

DESCRIPTION

FIG. 1 is a perspective view of a mobile phone;
FIG. 2 is a front view of the mobile phone of FIG. 1;
FIG. 3 is a rear view of the mobile phone of FIG. 1;
FIG. 4 is a left-side view of the mobile phone of FIG. 1;
FIG. 5 is a right-side view of the mobile phone of FIG. 1;
FIG. 6 is a top plan view of the mobile phone of FIG. 1;
FIG. 7 is a bottom plan view of the mobile phone of FIG. 1;
and,
FIG. 8 is an open perspective view of the mobile phone of FIG. 1.

1 Claim, 3 Drawing Sheets

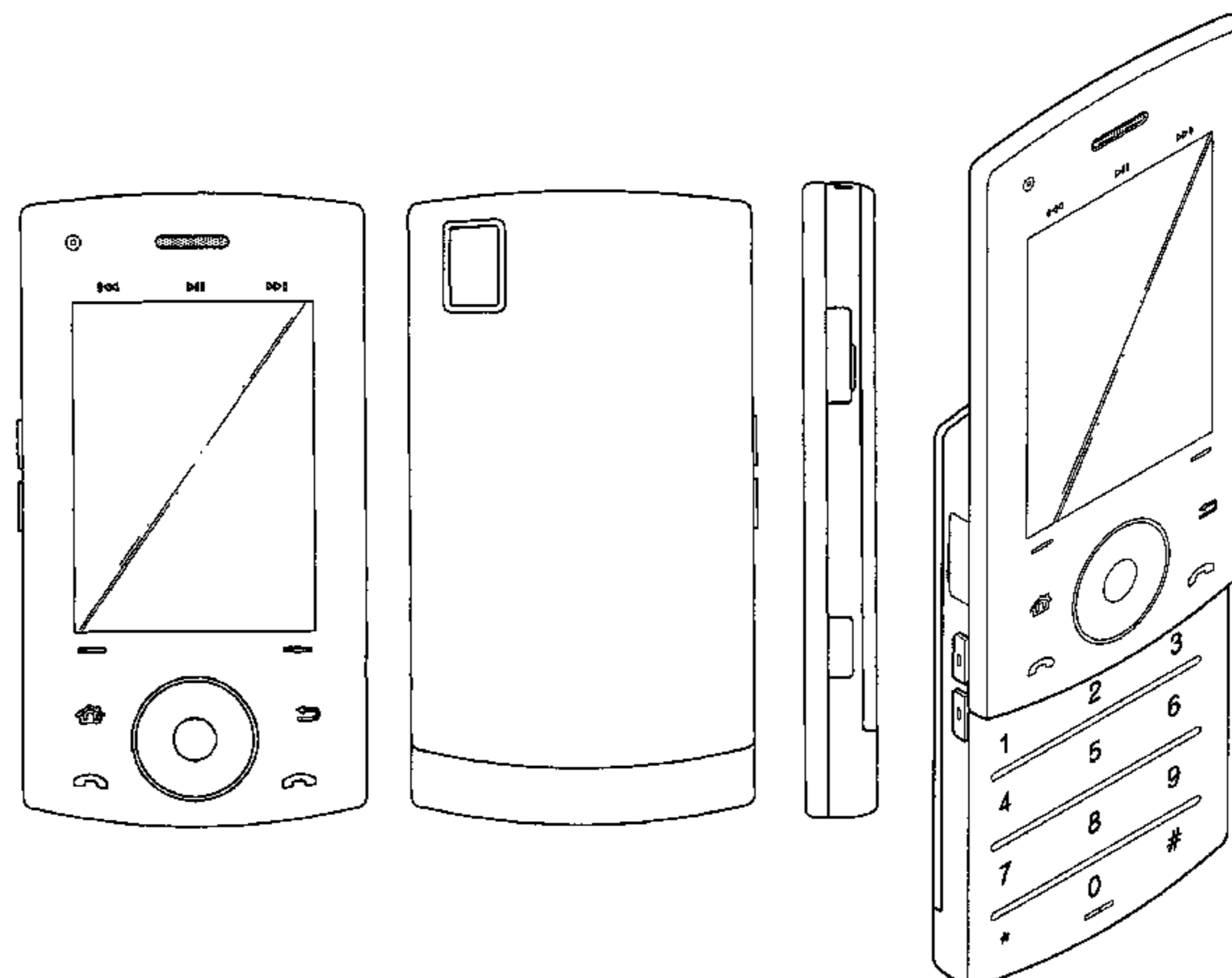

OTHER PUBLICATIONS

Sony Ericsson S500, announced May 2007, [online], [retrieved on May 18, 2007]. Retrieved from Internet ,<URL: <http://www.gsmarena.com>>.*

HTC P3300, announced Sep. 2006, [online], [retrieved on Feb. 20, 2007]. Retrieved from Internet ,<URL: <http://www.gsmarena.com>>.*

Motorola A1010, announced 1st quarter 2005, [online], [retrieved on Feb. 16, 2007]. Retrieved from Internet ,<URL: <http://www.gsmarena.com>>.*

* cited by examiner

FIG. 1

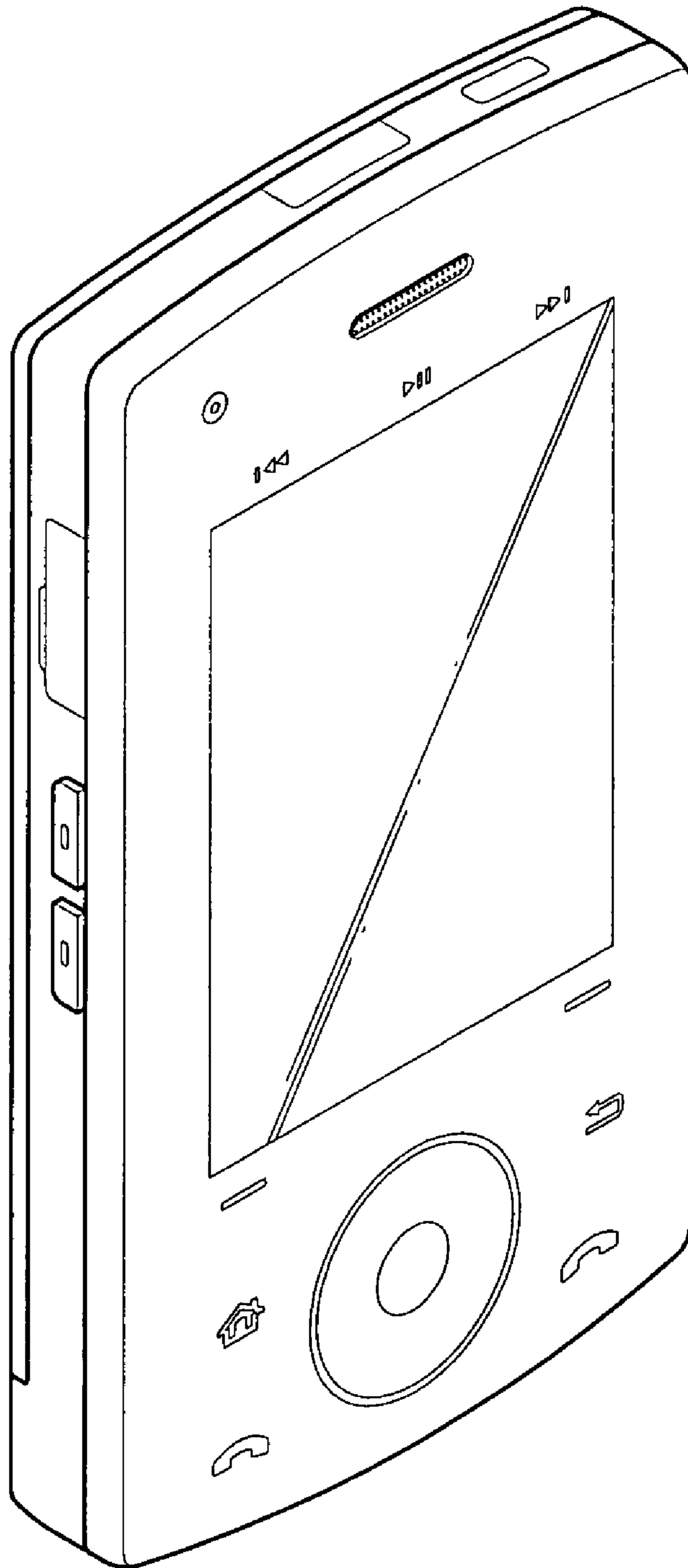

FIG.2

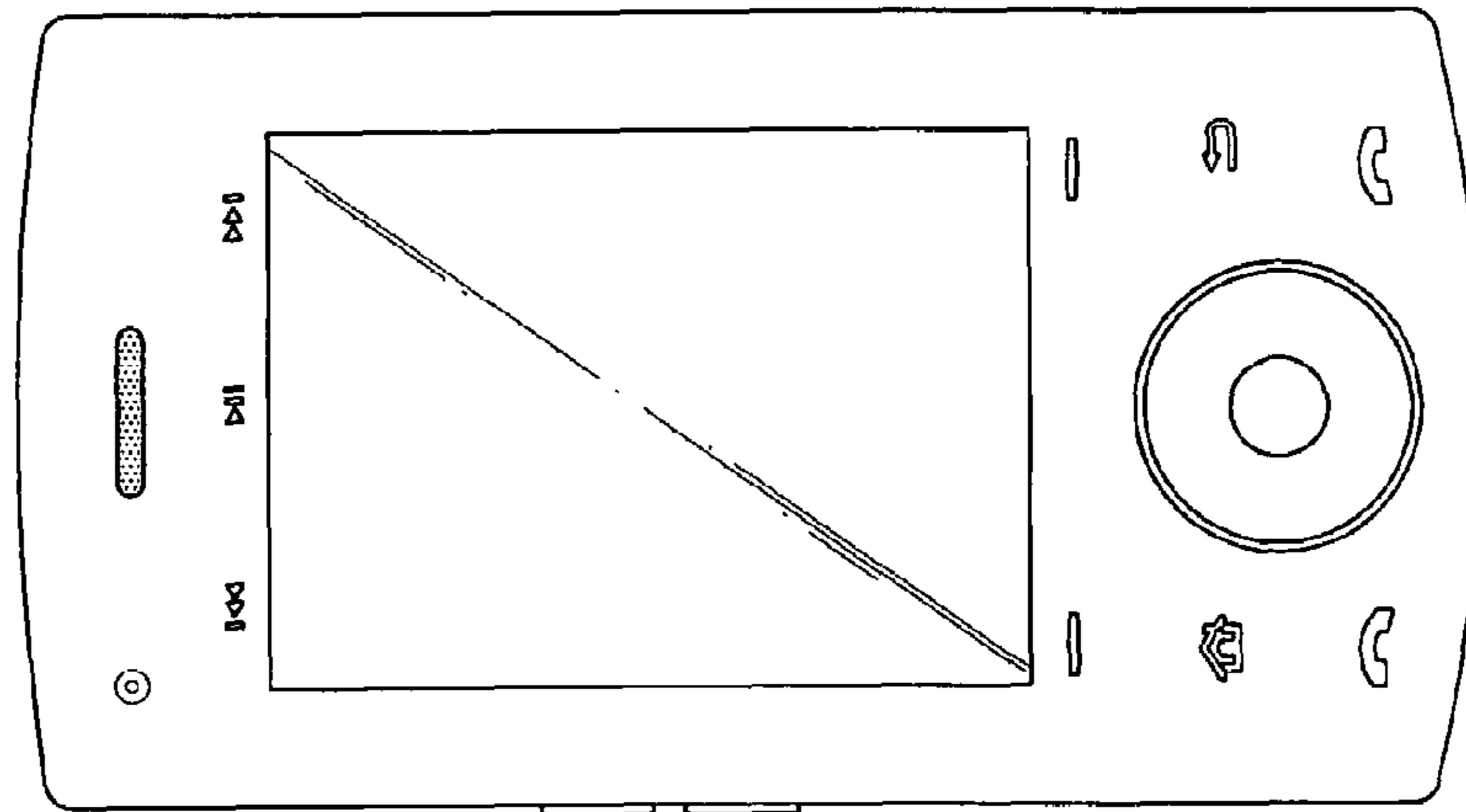

FIG.3

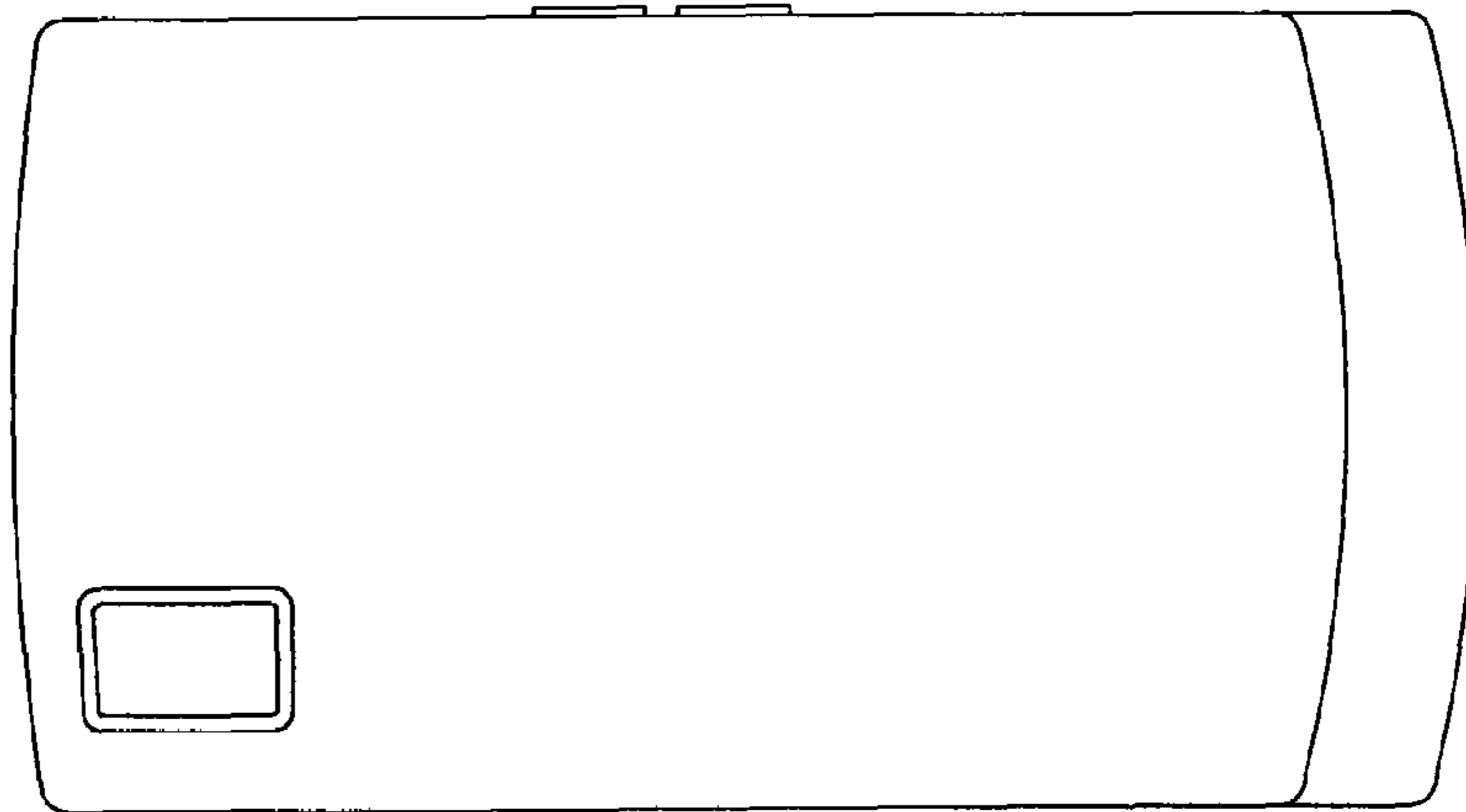

FIG.4

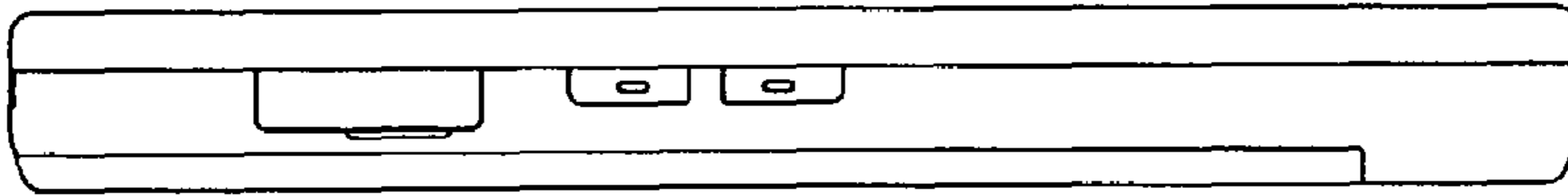

FIG.5

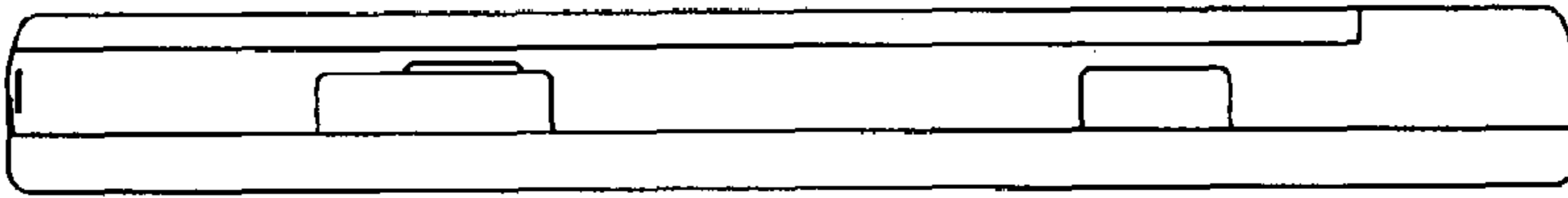

FIG.7

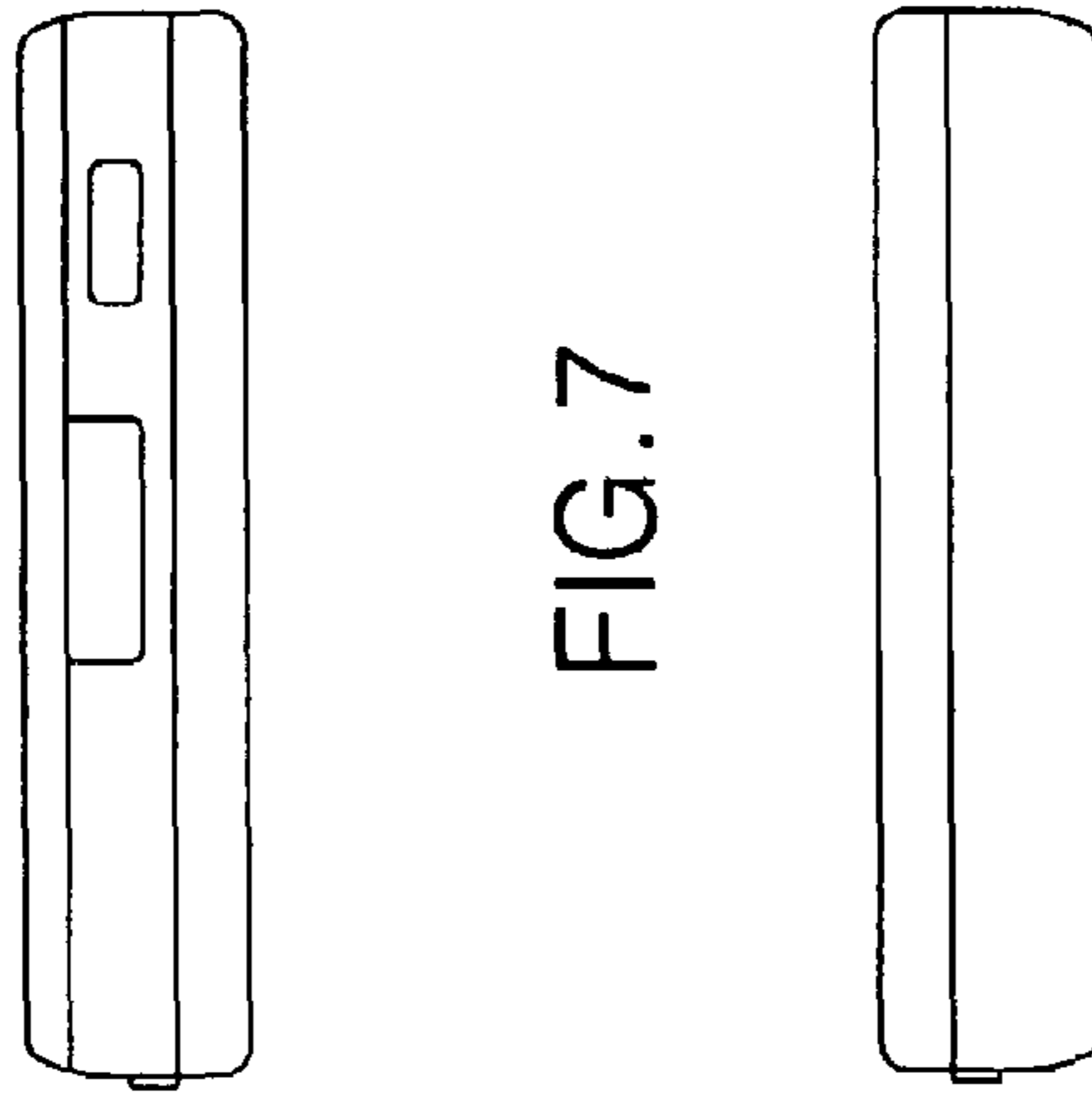

FIG.8

