



US00D563344S

(12) **United States Design Patent**
Kim et al.

(10) **Patent No.:** **US D563,344 S**
(45) **Date of Patent:** **** Mar. 4, 2008**

(54) **MOBILE PHONE**

(75) Inventors: **Young-Sae Kim**, Los Altos, CA (US);
Chi-Young Ahn, Seoul (KR);
Young-Ju Yeo, Seoul (KR);
Chang-Hwan Hwang, Goyang-si (KR)

(73) Assignee: **Samsung Electronics Co., Ltd.**,
Suwon-Si (KR)

(**) Term: **14 Years**

(21) Appl. No.: **29/253,886**

(22) Filed: **Feb. 15, 2006**

(30) **Foreign Application Priority Data**

Sep. 24, 2005 (KR) 30-2005-0032362

(51) **LOC (8) Cl.** **14-03**

(52) **U.S. Cl.** **D14/138**

(58) **Field of Classification Search** D14/496,
D14/138, 341-347; 455/575.3, 575.1; D21/517,
D21/329, 333

See application file for complete search history.

(56) **References Cited**

U.S. PATENT DOCUMENTS

D485,249 S *	1/2004	Liao et al.	D14/138
D486,488 S *	2/2004	Olodort et al.	D14/396
D496,020 S *	9/2004	Lee	D14/138
6,798,649 B1 *	9/2004	Olodort et al.	361/683
D500,480 S *	1/2005	Daw	D14/138
D502,161 S *	2/2005	Kim et al.	D14/138
D507,787 S *	7/2005	Ahn et al.	D14/138
D518,467 S *	4/2006	Kim et al.	D14/138
D519,966 S *	5/2006	Salmi et al.	D14/138
7,110,797 B2 *	9/2006	Soejima	455/575.1
D539,772 S *	4/2007	Park et al.	D14/138
D540,790 S *	4/2007	Kim et al.	D14/345
D541,248 S *	4/2007	Lee et al.	D14/138
D543,170 S *	5/2007	Kim et al.	D14/138

D543,172 S *	5/2007	Lee et al.	D14/138
D543,173 S *	5/2007	Park et al.	D14/138
D545,287 S *	6/2007	Han et al.	D14/138
D546,795 S *	7/2007	Kim et al.	D14/138
2004/0048632 A1 *	3/2004	Kuroda	455/550.1
2004/0142734 A1 *	7/2004	Kim	455/575.1
2005/0026658 A1 *	2/2005	Soejima	455/575.1
2005/0113156 A1 *	5/2005	Park et al.	455/575.4
2005/0148375 A1 *	7/2005	DeLine	455/575.3
2006/0135222 A1 *	6/2006	Kim	455/575.1
2006/0229117 A1 *	10/2006	Lehtonen	455/575.3

OTHER PUBLICATIONS

Samsung D300 telephone, announced Feb. 2006, [online],
[retrieved on Sep. 17, 2007]. Retrieved from Internet ,<URL:
http://www.gsmarena.com>.*

Samsung SPH-P9000 telephone, posted Nov. 8, 2006, [online],
[retrieved on Feb. 4, 2007]. Retrieved from Internet ,<URL: http://
www.mobiletechnews.com>.*

* cited by examiner

Primary Examiner—Jeffrey Asch

(74) *Attorney, Agent, or Firm*—Staas & Halsey LLP

(57) **CLAIM**

The ornamental design for the mobile phone, as shown and
described.

DESCRIPTION

FIG. 1 is a perspective view of the mobile phone showing
our design;

FIG. 2 is a front view thereof;

FIG. 3 is a rear view thereof;

FIG. 4 is a left side view thereof;

FIG. 5 is a right side view thereof;

FIG. 6 is a top plan view thereof;

FIG. 7 is a bottom plan view thereof; and,

FIG. 8 is a perspective, open view thereof.

1 Claim, 6 Drawing Sheets

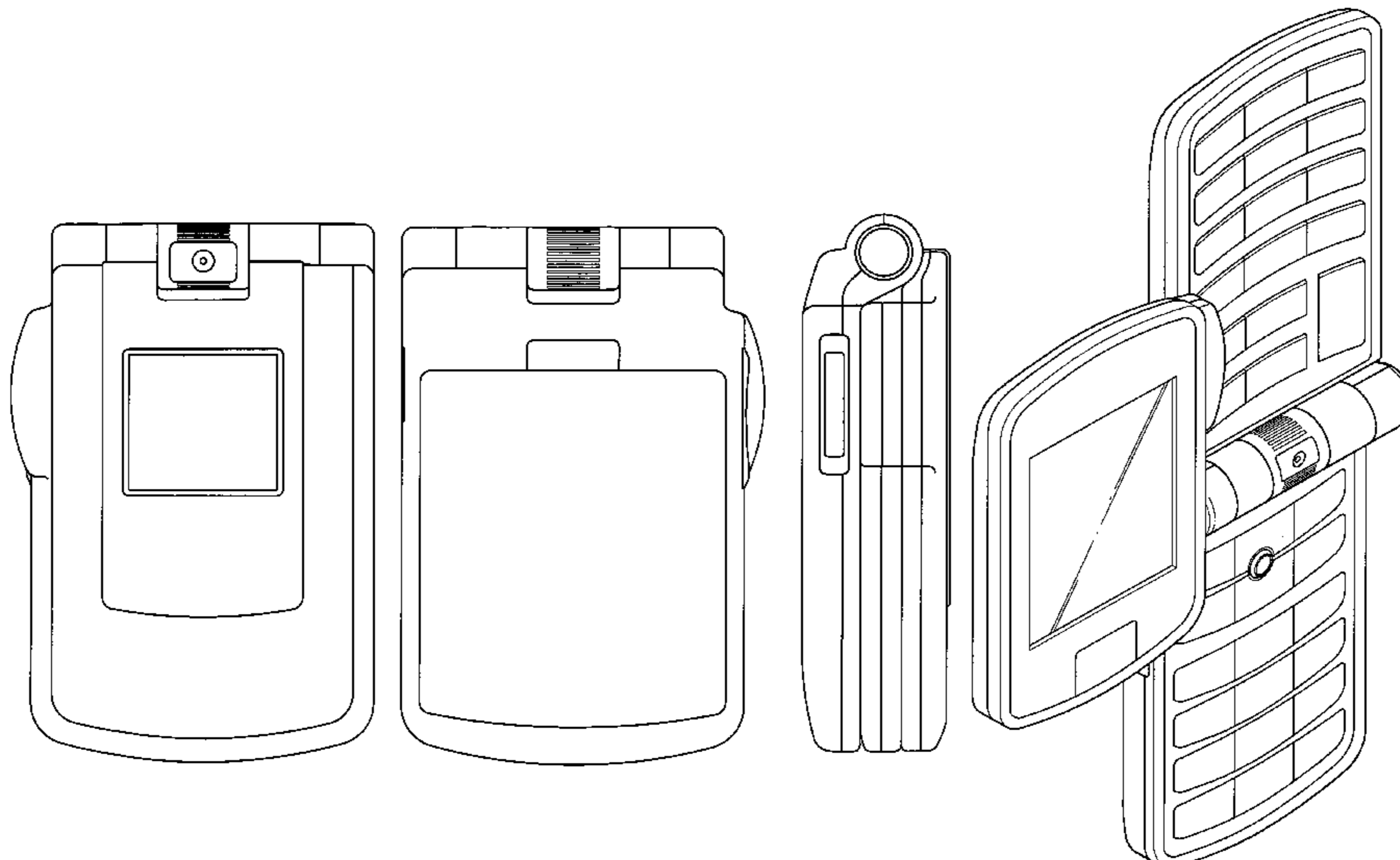

FIG. 1

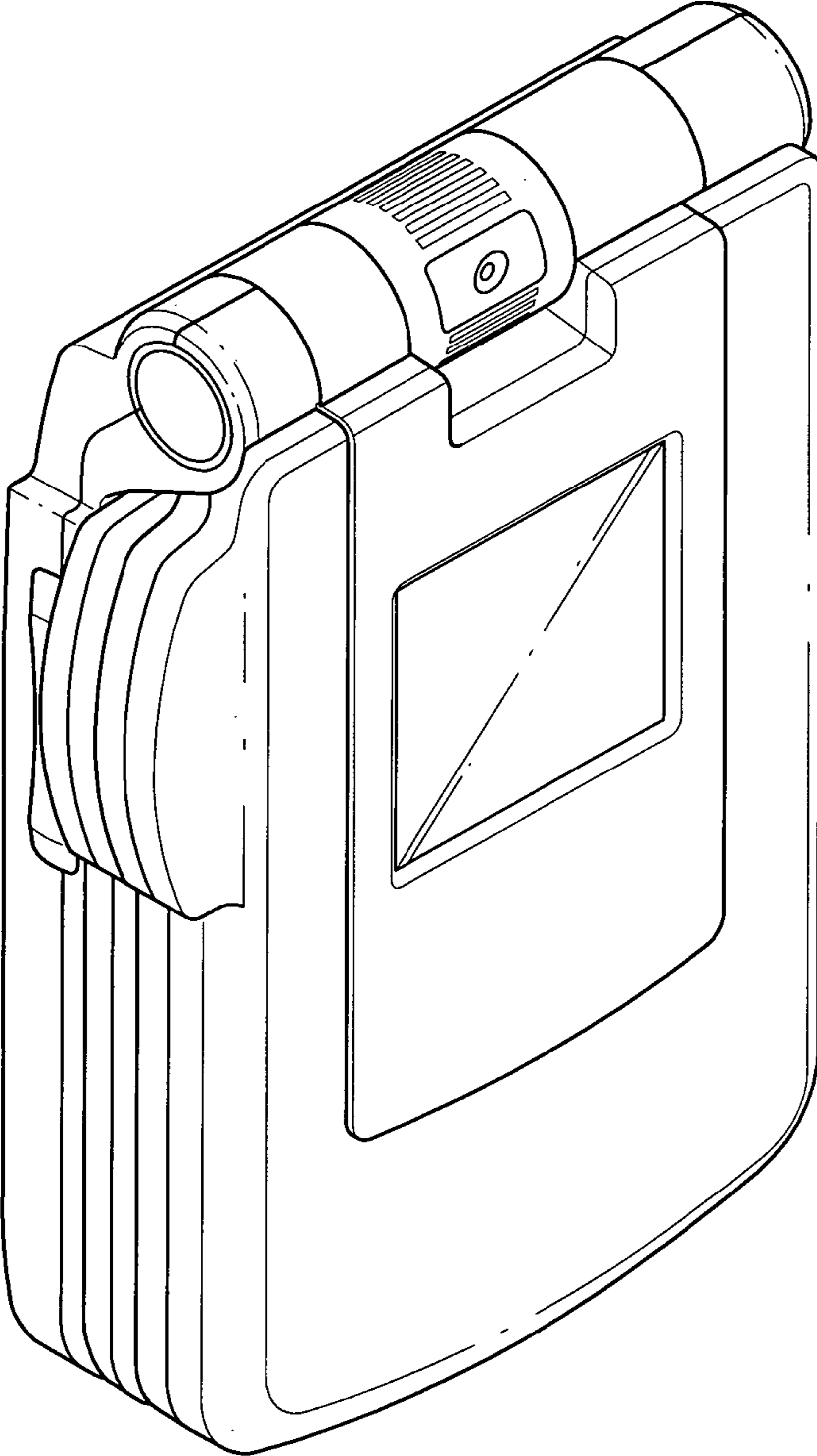

FIG. 2

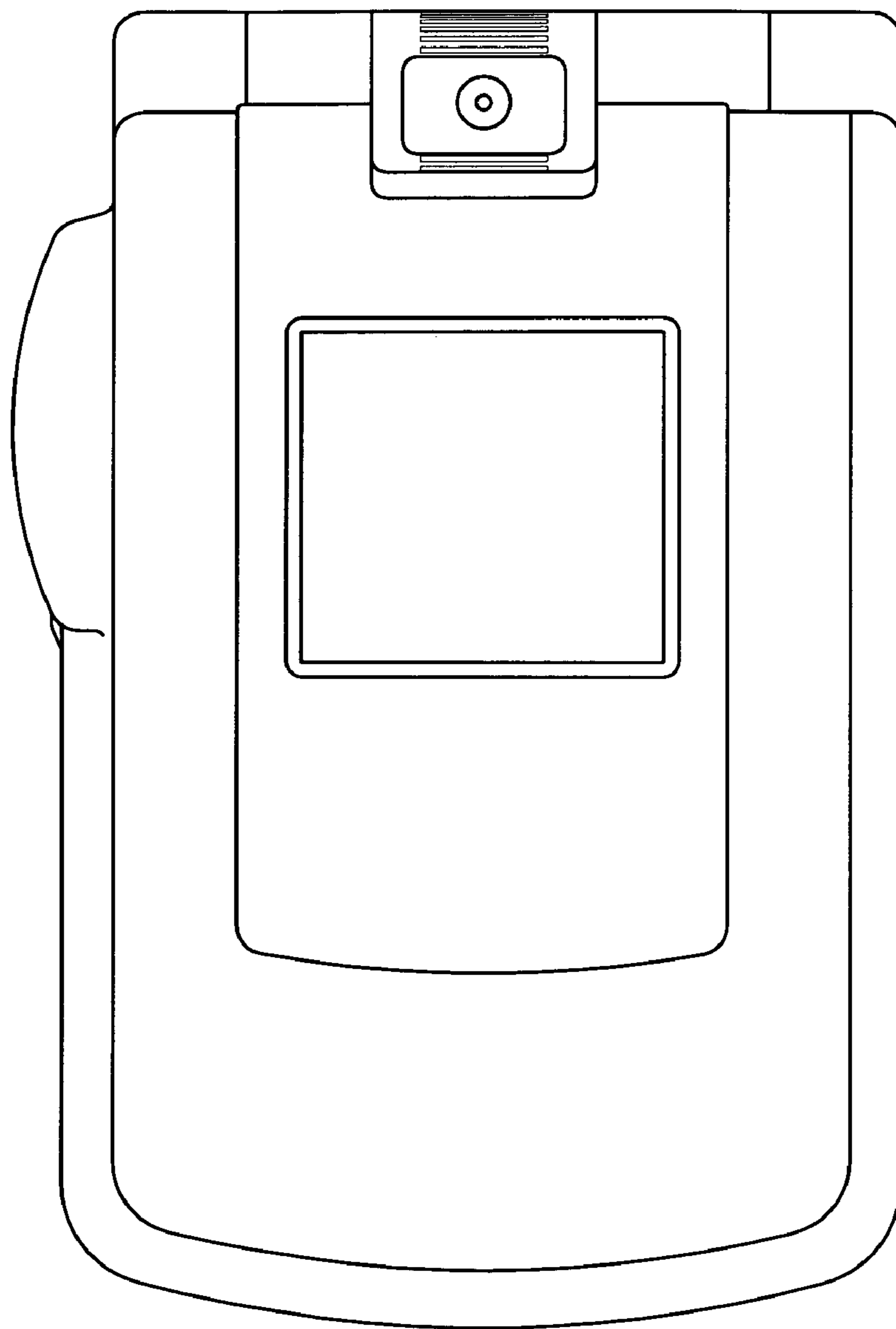

FIG. 3

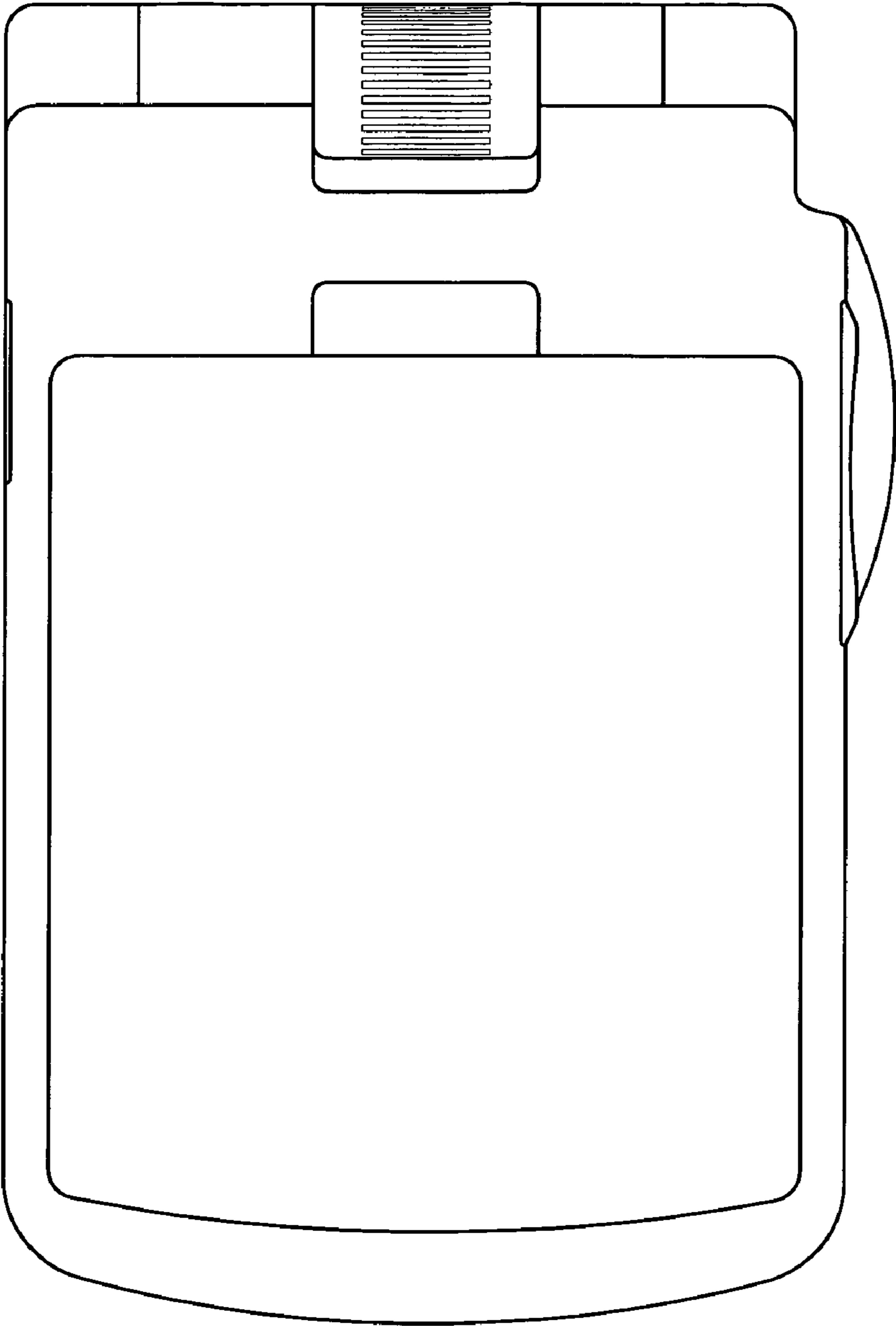

FIG. 4

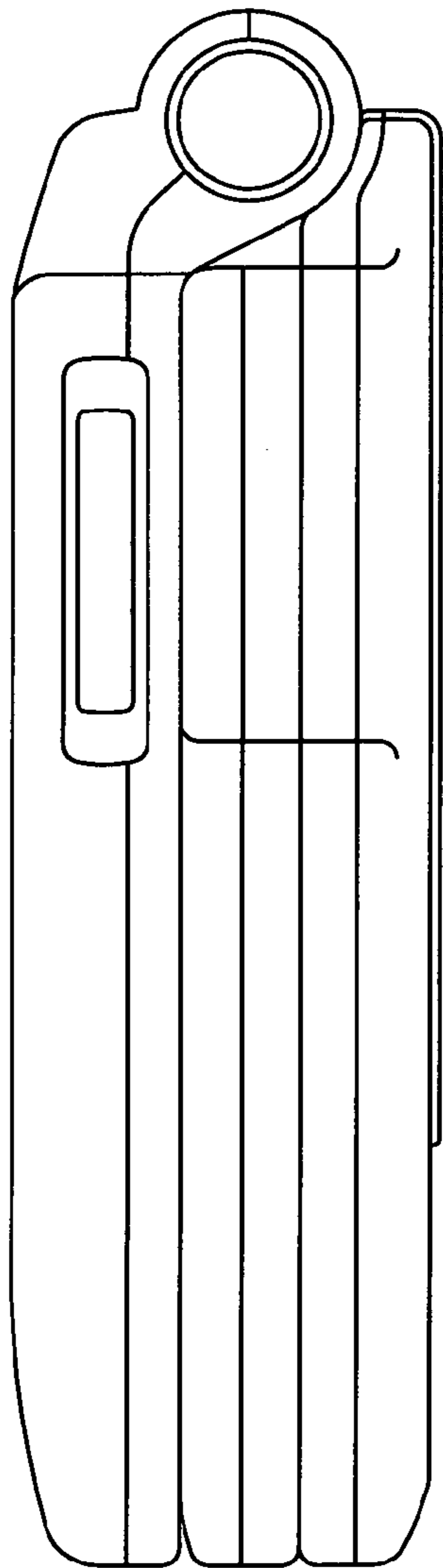

FIG. 5

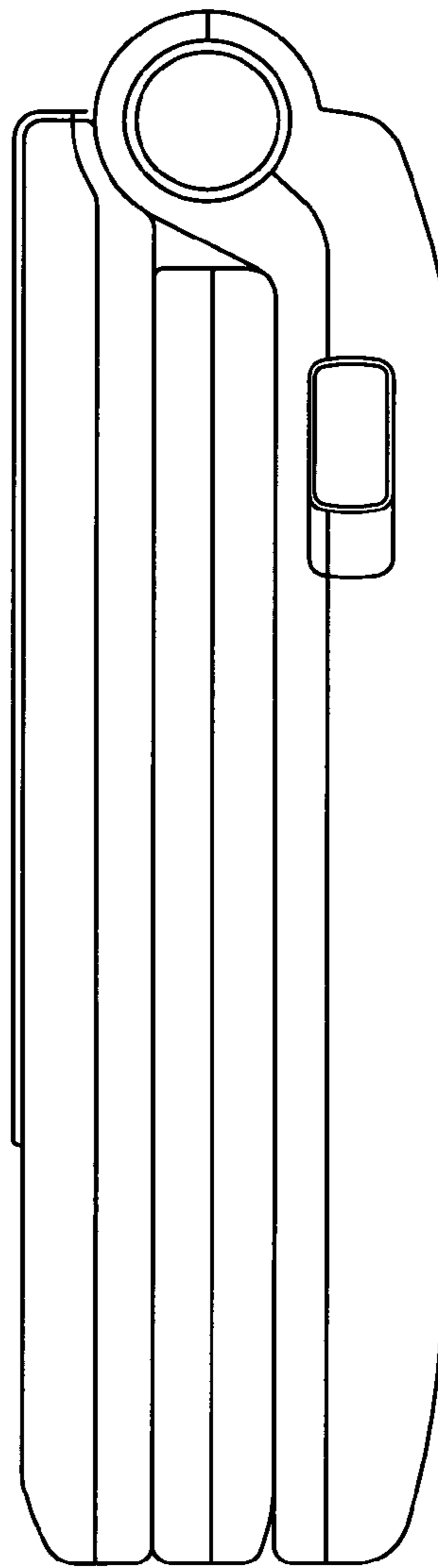

FIG. 6

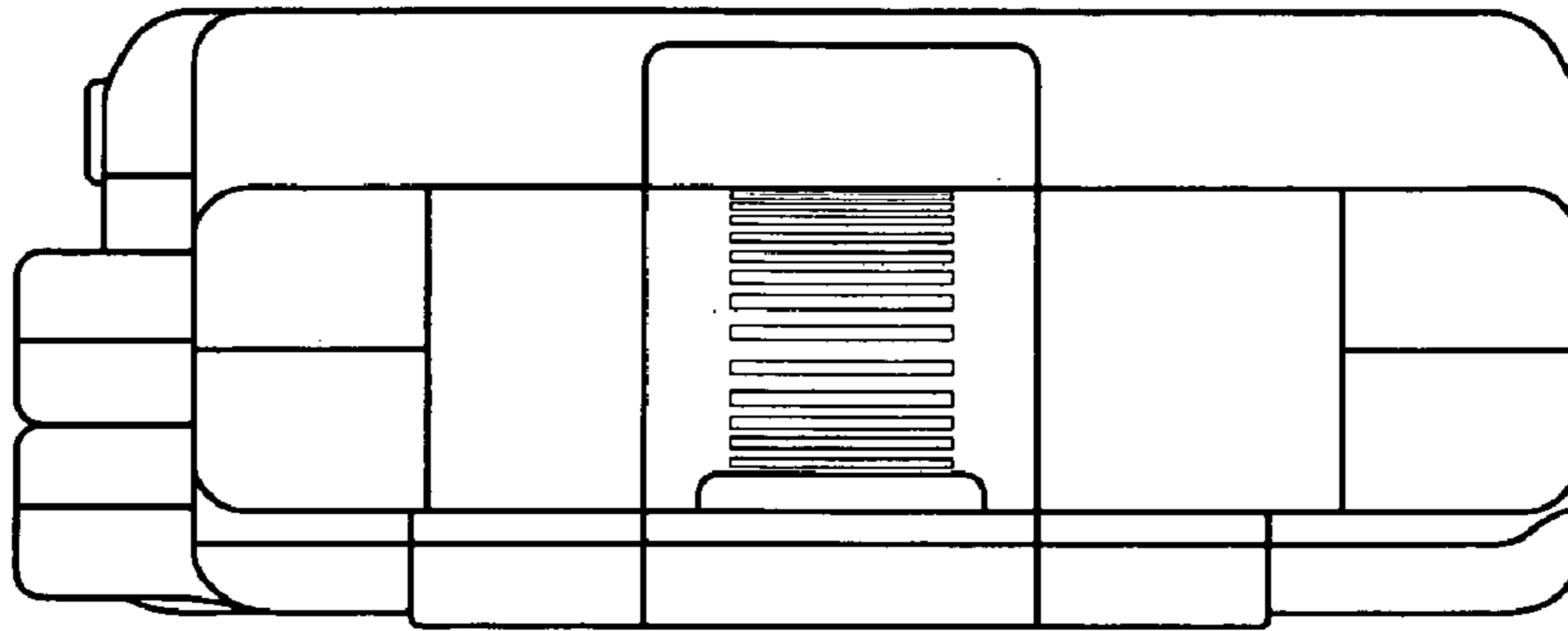

FIG. 7

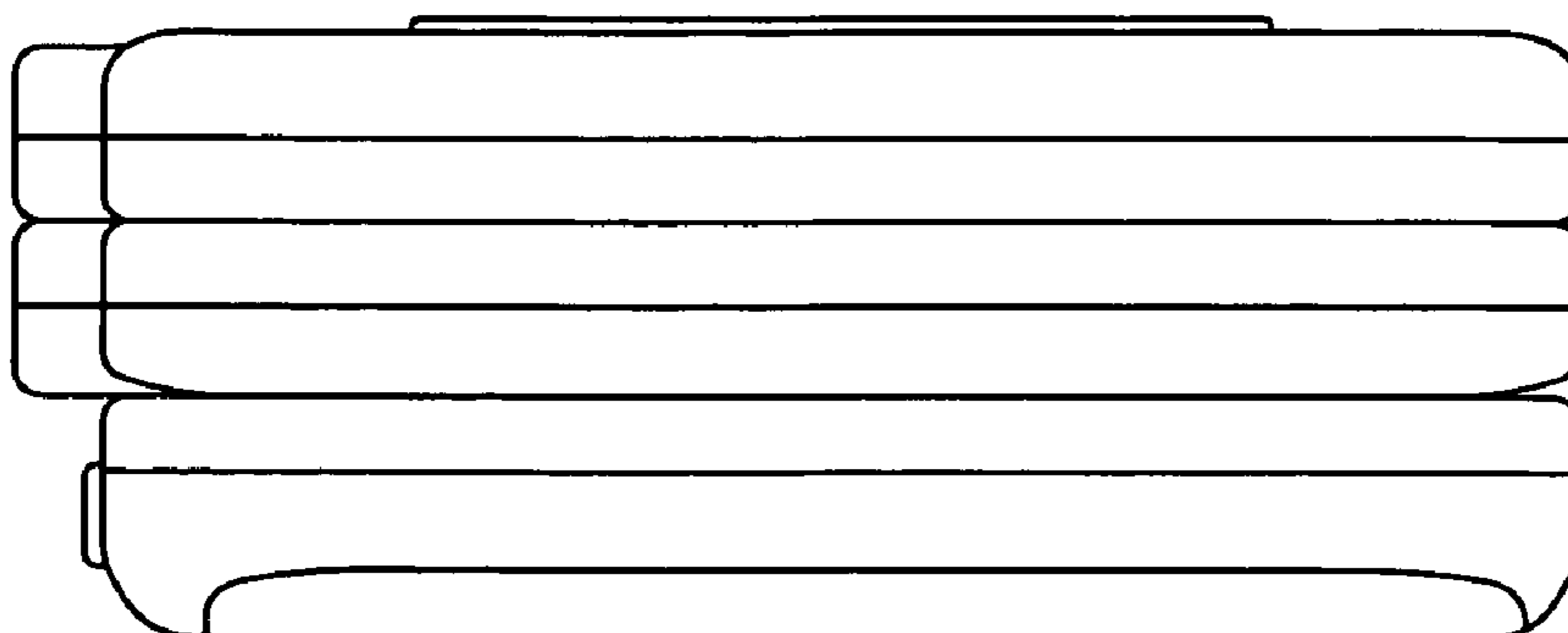

FIG. 8

