

US00D563269S

(12) **United States Design Patent**
Anscher

(10) **Patent No.:** **US D563,269 S**
(45) **Date of Patent:** **** Mar. 4, 2008**

(54) **MALE BUCKLE PORTION**

(76) Inventor: **Joseph Anscher**, 1928 Midlane,
Muttontown, NY (US) 11791

(**) Term: **14 Years**

(21) Appl. No.: **29/273,330**

(22) Filed: **Mar. 2, 2007**

(51) **LOC (8) Cl.** **02-07**

(52) **U.S. Cl.** **D11/216**

(58) **Field of Classification Search** D11/200-201,
D11/206-210, 214-216, 218; 24/163 R,
24/169-171, 173, 177-179, 191, 194, 195,
24/200, 197

See application file for complete search history.

(56) **References Cited**

U.S. PATENT DOCUMENTS

D386,125 S *	11/1997	Anscher	D11/218
D397,641 S *	9/1998	Hamilton et al.	D11/216
D519,878 S *	5/2006	Anscher	D11/216
D538,197 S *	3/2007	Wemmer	D11/216

* cited by examiner

Primary Examiner—Ralf Seifert

(74) *Attorney, Agent, or Firm*—Collard & Roe, P.C.

(57) **CLAIM**

The ornamental design for a male buckle portion, as shown and described.

DESCRIPTION

FIG. 1 shows a top perspective view of my design for a male buckle portion according to the invention;

FIG. 2 shows a bottom perspective view thereof;

FIG. 3 shows a top view thereof;

FIG. 4 shows a side view thereof, with the opposite side view being a mirror image thereof;

FIG. 5 shows a bottom view thereof;

FIG. 6 shows a front end view thereof;

FIG. 7 shows a rear end view thereof; and,

FIG. 8 shows a perspective view of the male buckle portion inserted into a corresponding female buckle portion.

The areas in dotted lines show environmental structure only and are not part of the claimed invention.

1 Claim, 4 Drawing Sheets

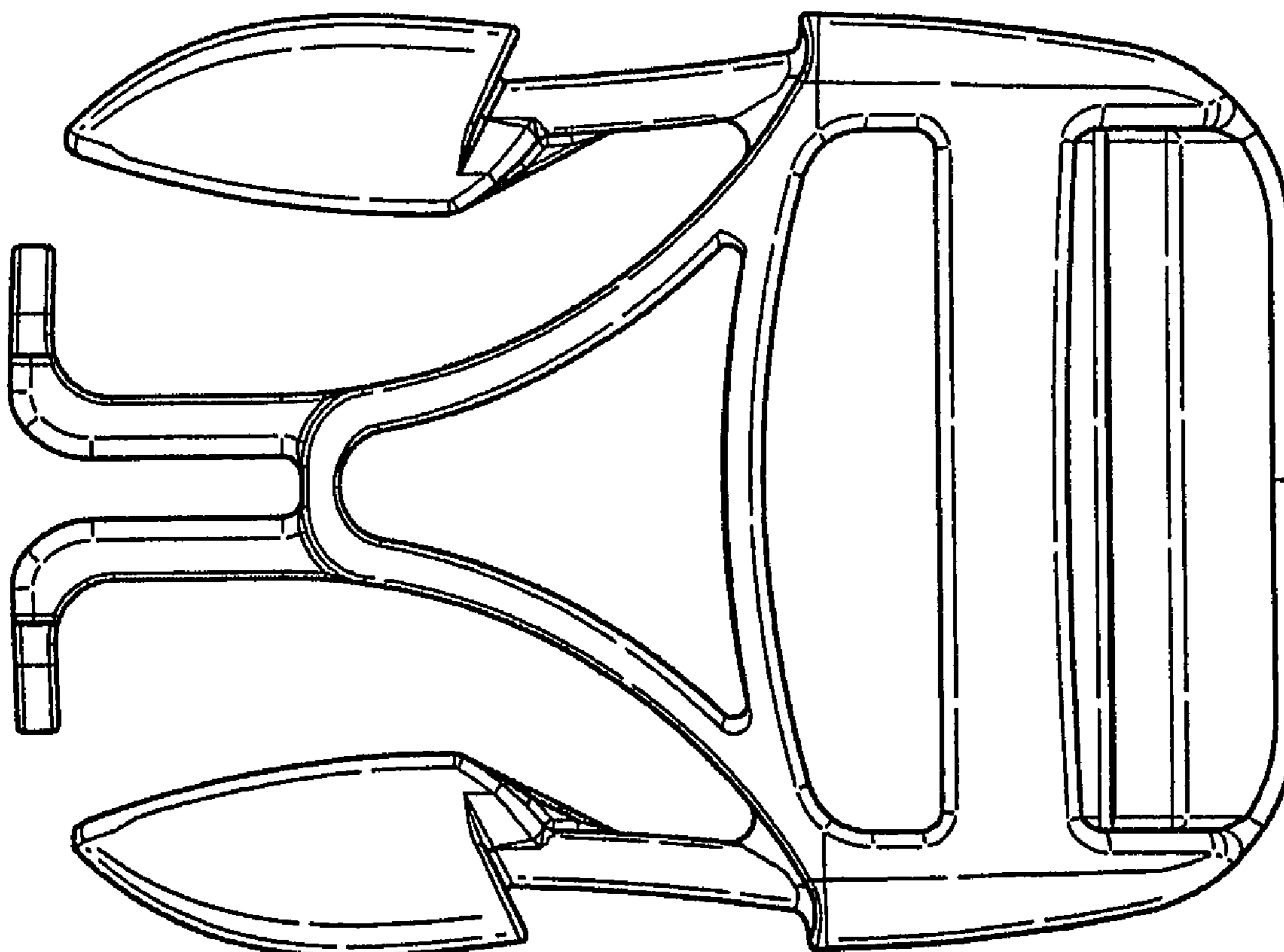

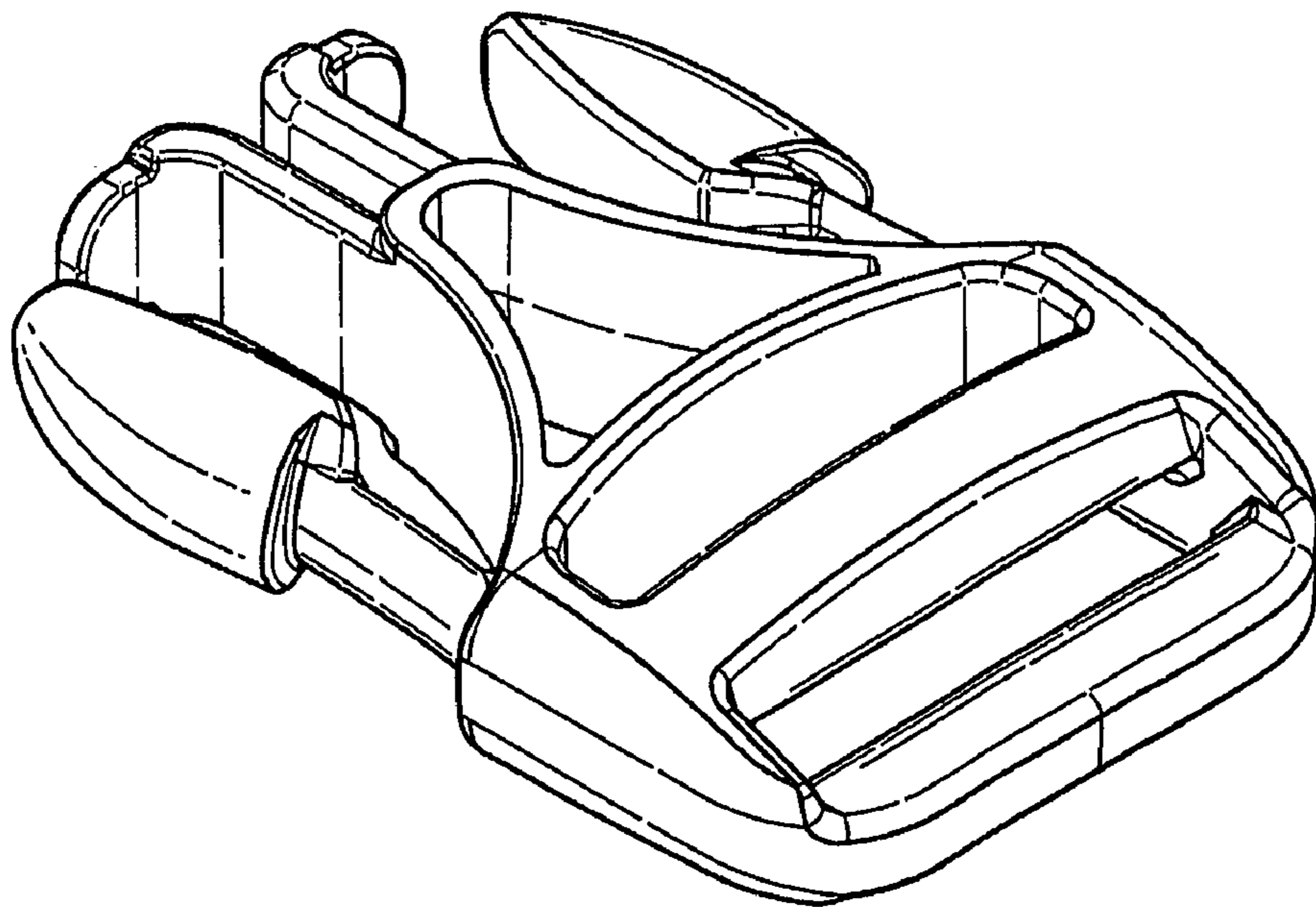

FIG. 1

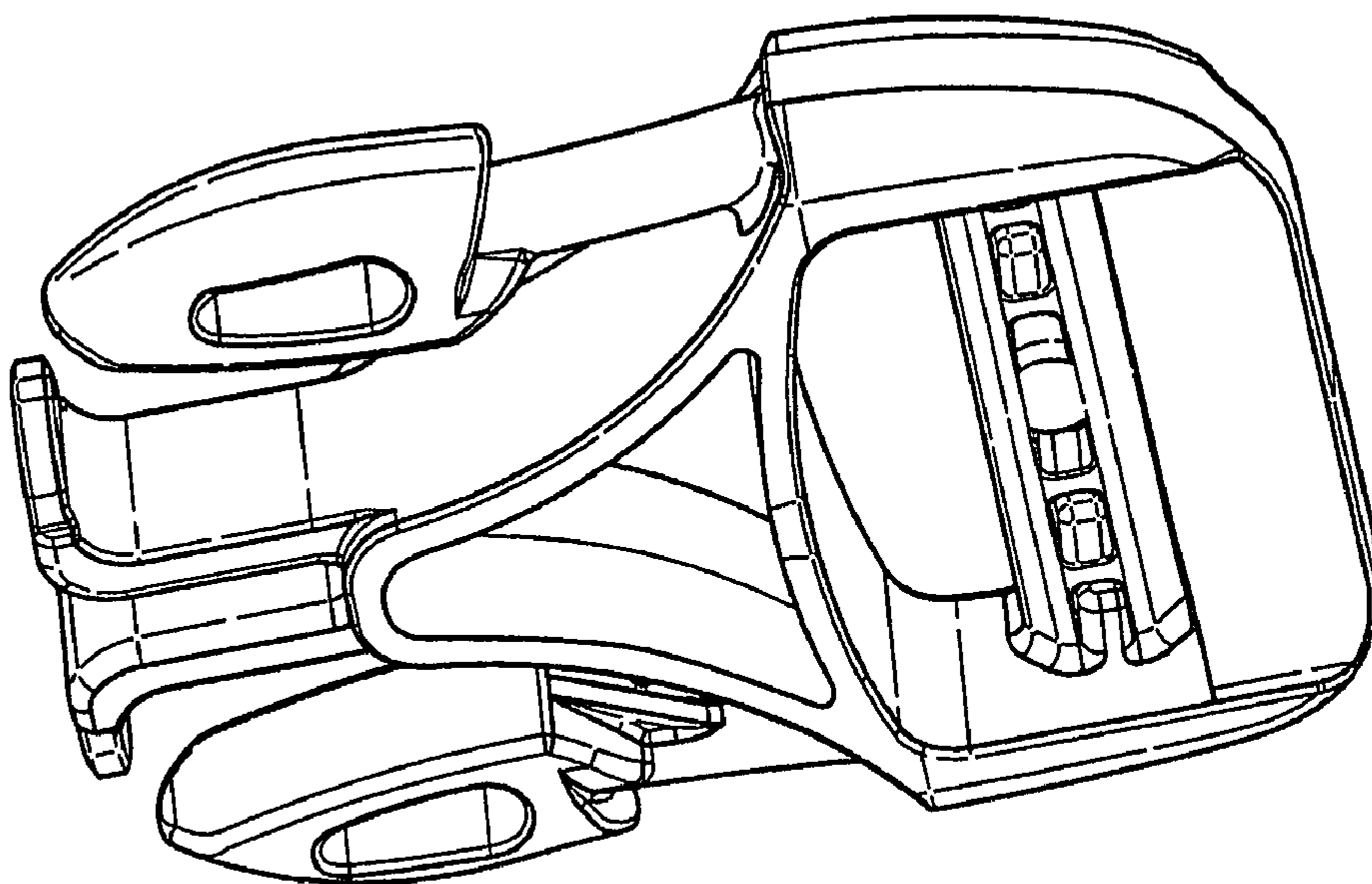

FIG. 2

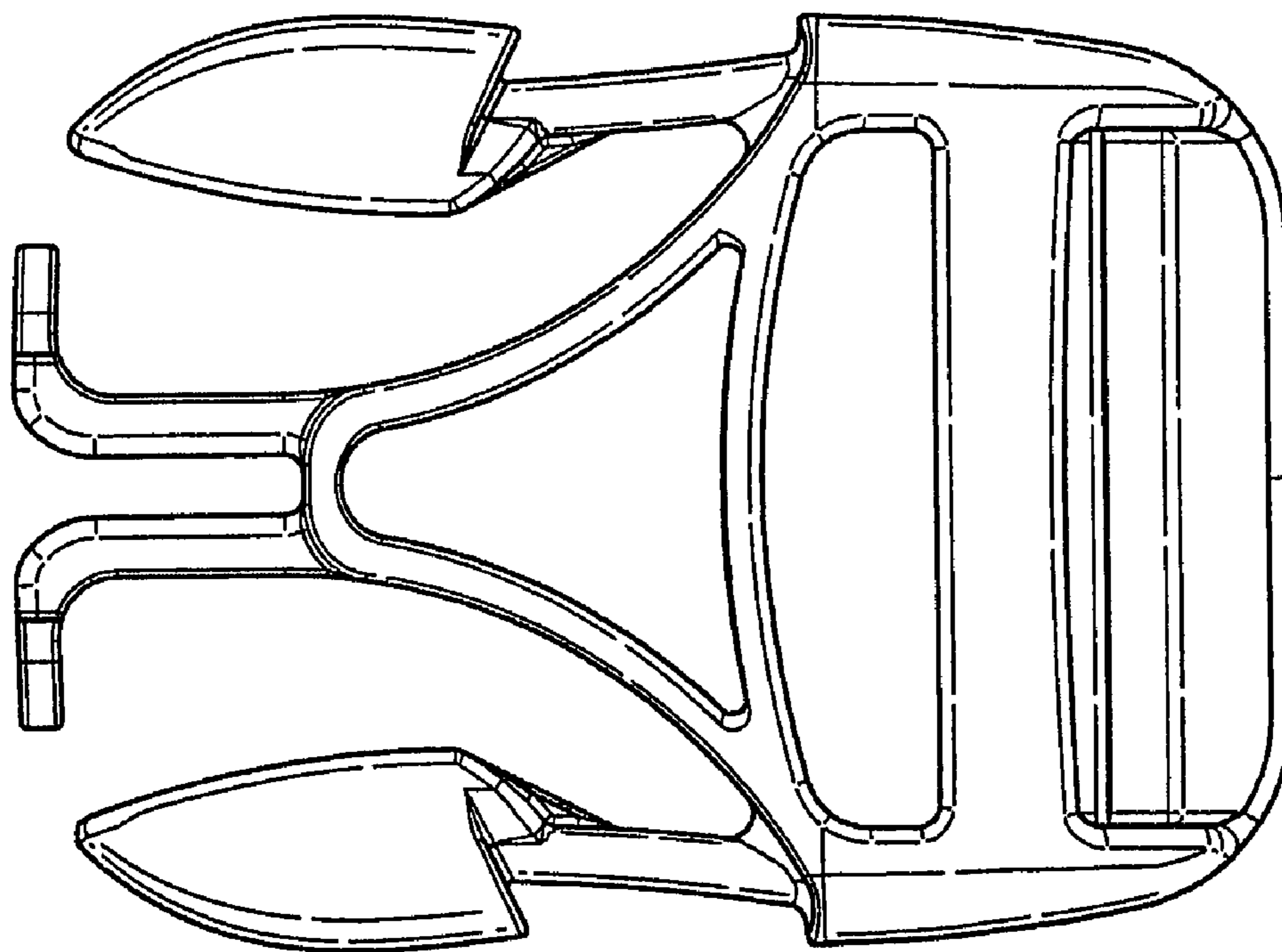

FIG. 3

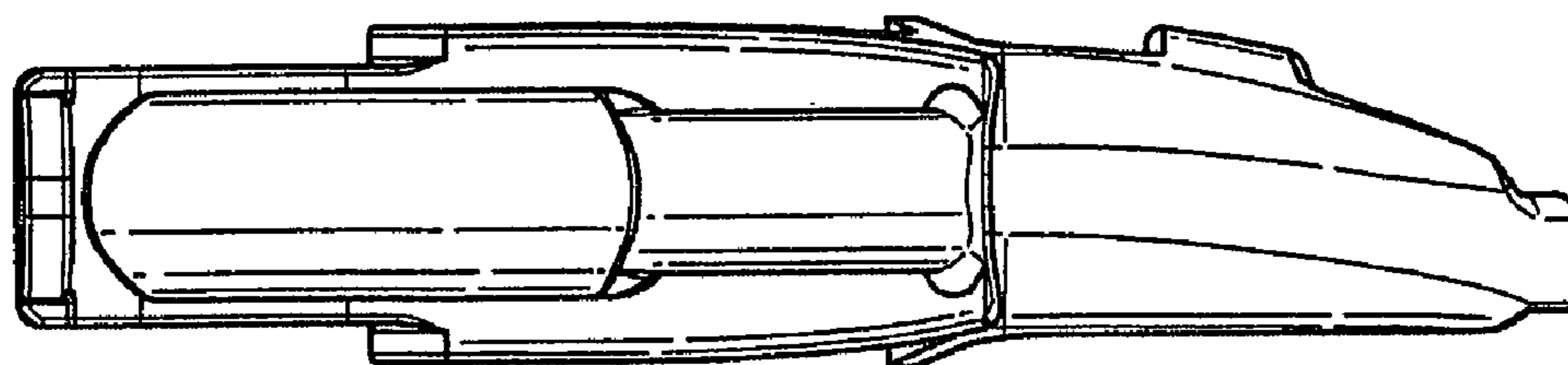

FIG. 4

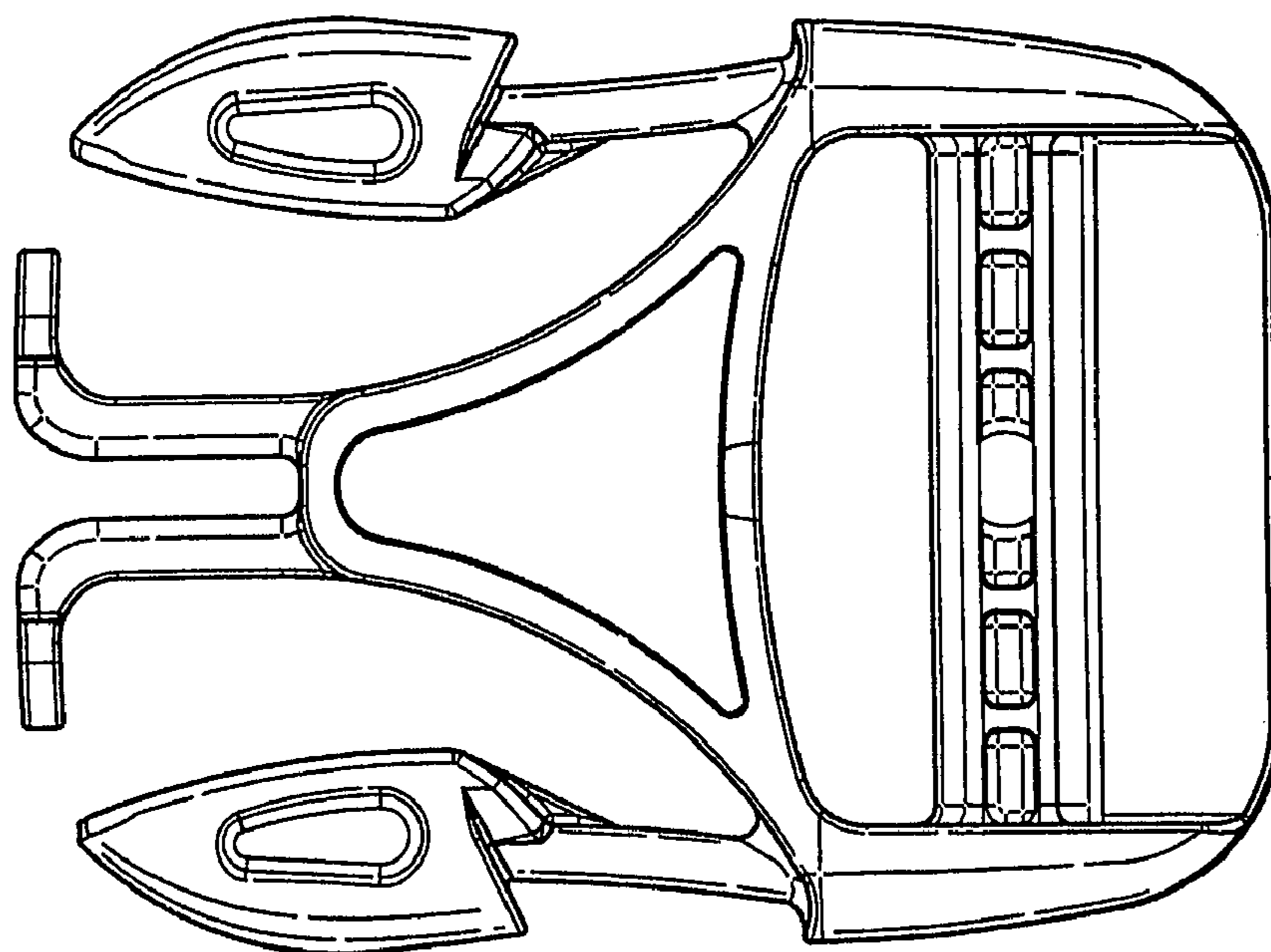

FIG. 5

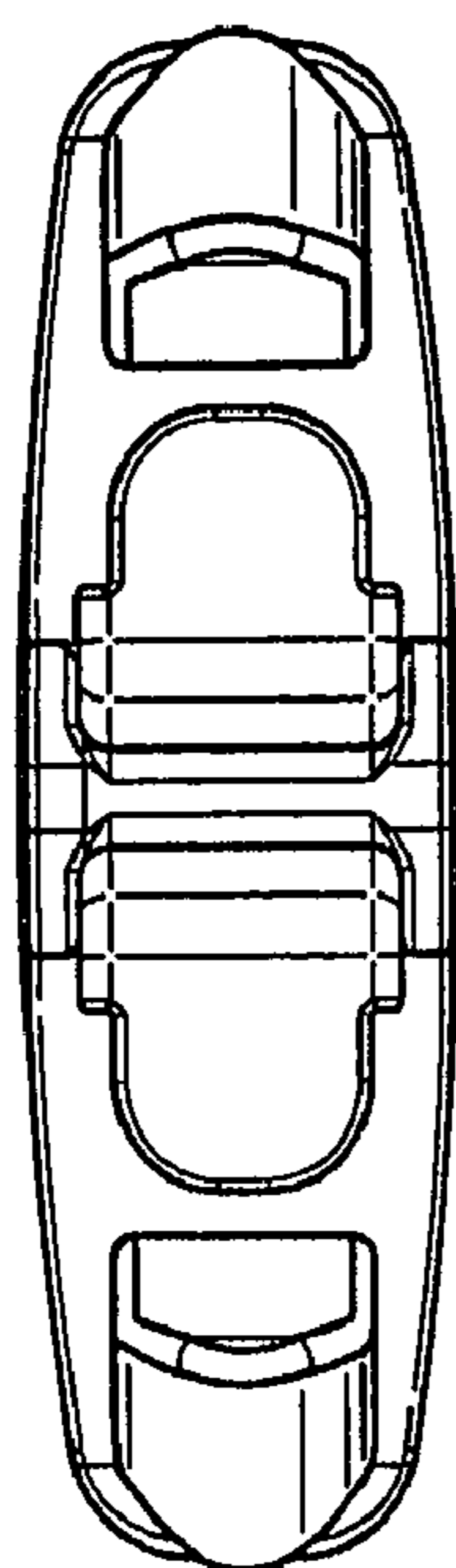

FIG. 6

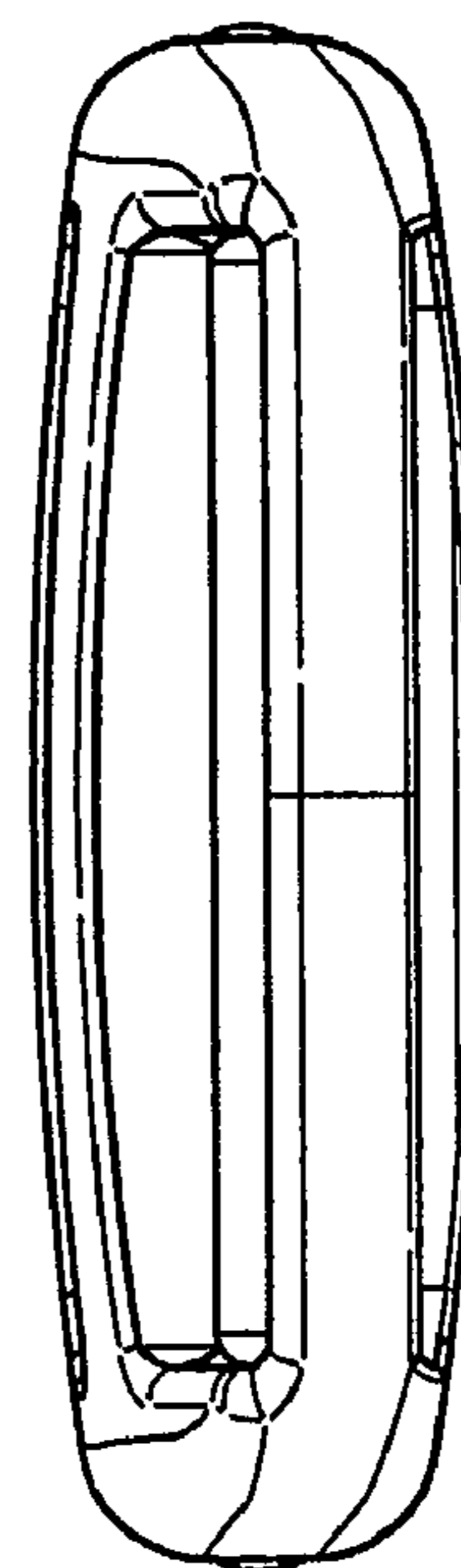

FIG. 7

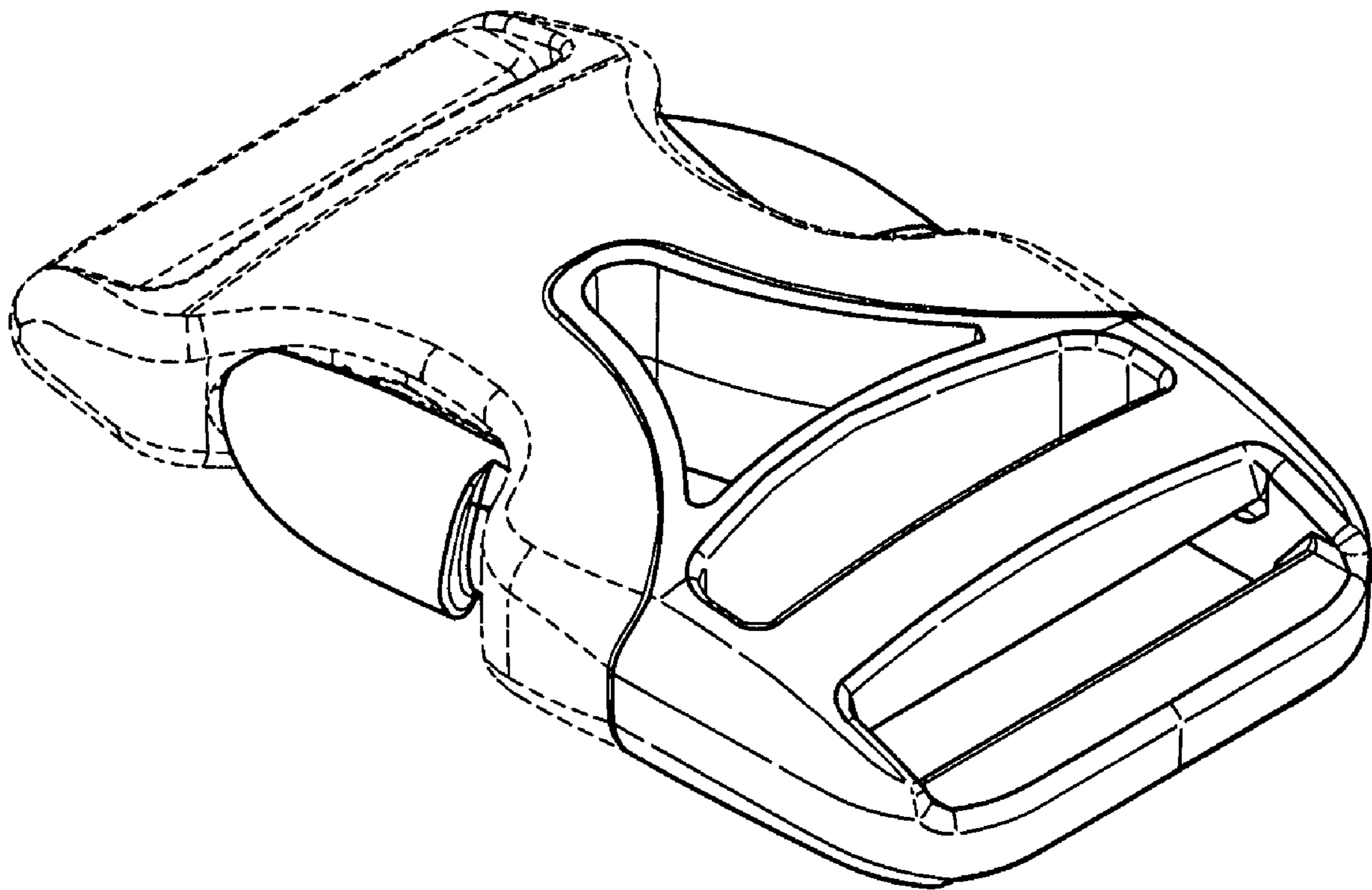

FIG. 8