



US00D563120S

(12) **United States Design Patent**
Malley et al.

(10) **Patent No.:** **US D563,120 S**
(45) **Date of Patent:** **** Mar. 4, 2008**

(54) **TOOL CHEST AND CABINET**

D536,202 S * 2/2007 Mehmen et al. D6/510

* cited by examiner

(75) Inventors: **John P. Malley**, Cedar Falls, IA (US);
Daniel L. Jackson, Center Point, IA (US)

Primary Examiner—Mimosa De
(74) *Attorney, Agent, or Firm*—Calfee, Halter & Griswold LLP

(73) Assignee: **Waterloo Industries, Inc.**, Waterloo, IA (US)

(57) **CLAIM**

(**) Term: **14 Years**

We claim the ornamental design for a tool chest and cabinet, as shown and described.

(21) Appl. No.: **29/279,859**

(22) Filed: **May 9, 2007**

DESCRIPTION

(51) **LOC (8) Cl.** **06-04**

FIG. 1 is a perspective view of a tool chest and cabinet of the new design;

(52) **U.S. Cl.** **D6/445**

FIG. 2 is a front elevation view of the tool chest and cabinet of FIG. 1;

(58) **Field of Classification Search** D6/396,
D6/397, 432–448, 510; D3/275, 294–297,
D3/903, 905; 312/107, 117, 125, 204, 209,
312/224, 249.1, 249.11, 249.12, 257.1, 308
See application file for complete search history.

FIG. 3 is a rear view of the tool chest and cabinet of FIG. 1;
FIG. 4 is a left side view of the tool chest and cabinet of FIG. 1;

(56) **References Cited**

U.S. PATENT DOCUMENTS

- 840,347 A * 1/1907 Knapp 312/224
- D229,262 S * 11/1973 Pearson D6/433
- D430,426 S * 9/2000 Bieker et al. D6/445
- D505,237 S 5/2005 Schmidt et al.
- D514,854 S 2/2006 Schmidt et al.
- D520,784 S 5/2006 Schmidt et al.

FIG. 5 is a right side view of the tool chest and cabinet of FIG. 1;

FIG. 6 is a top view of the tool chest and cabinet of FIG. 1; and,

FIG. 7 is a bottom view of the tool chest and cabinet of FIG. 1.

The portions of the Figures shown in phantom lines form no part of the claimed design and for illustrative purposes only.

1 Claim, 6 Drawing Sheets

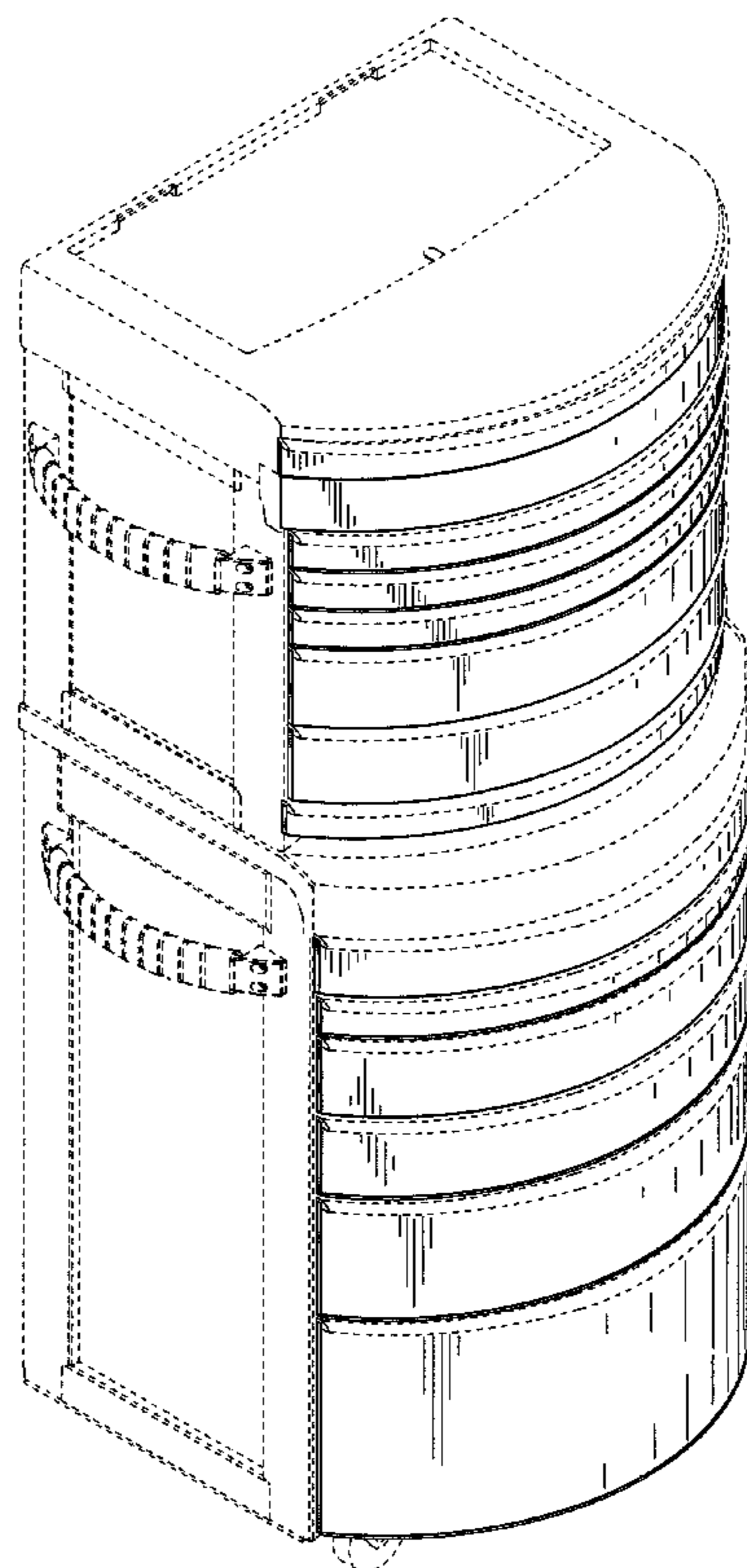

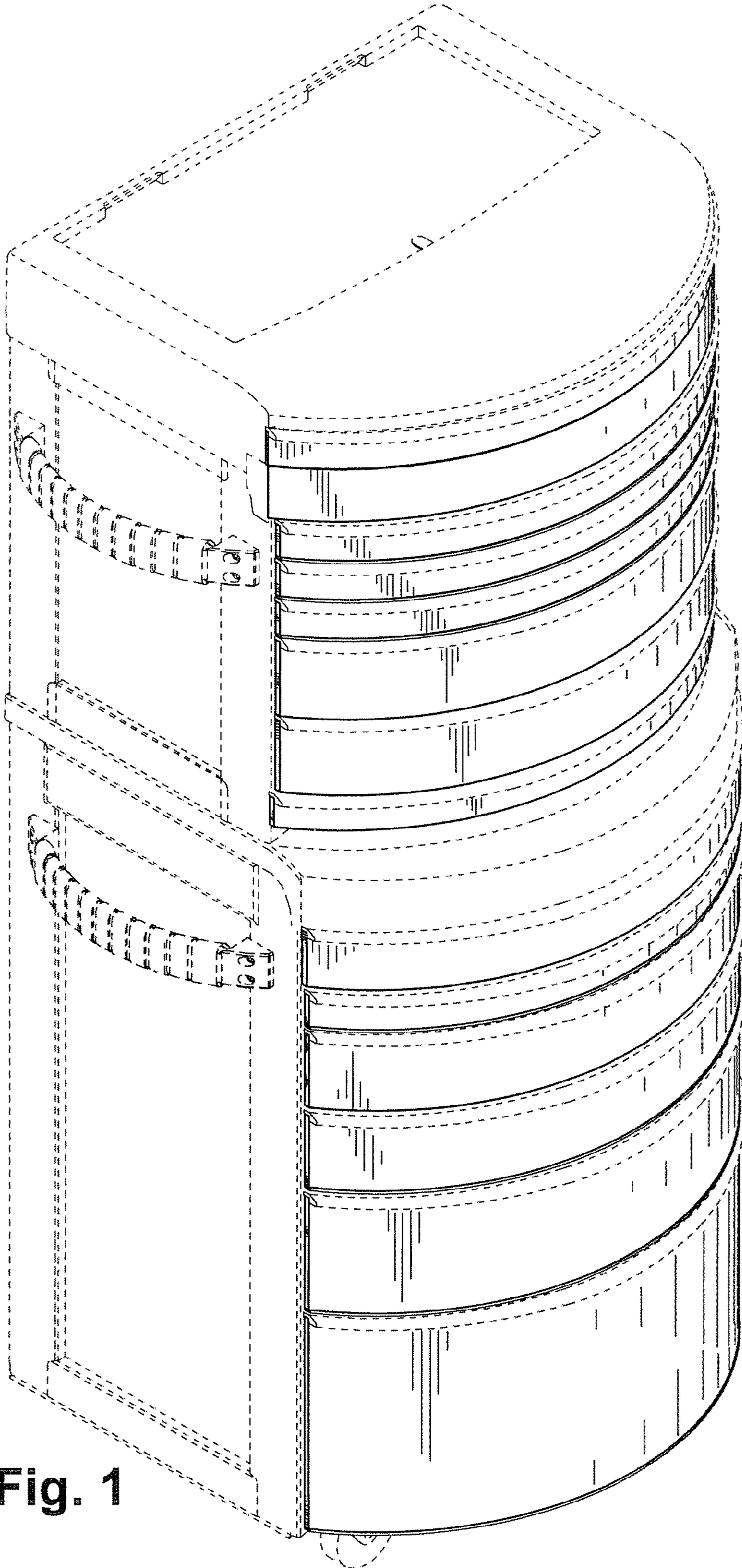

Fig. 1

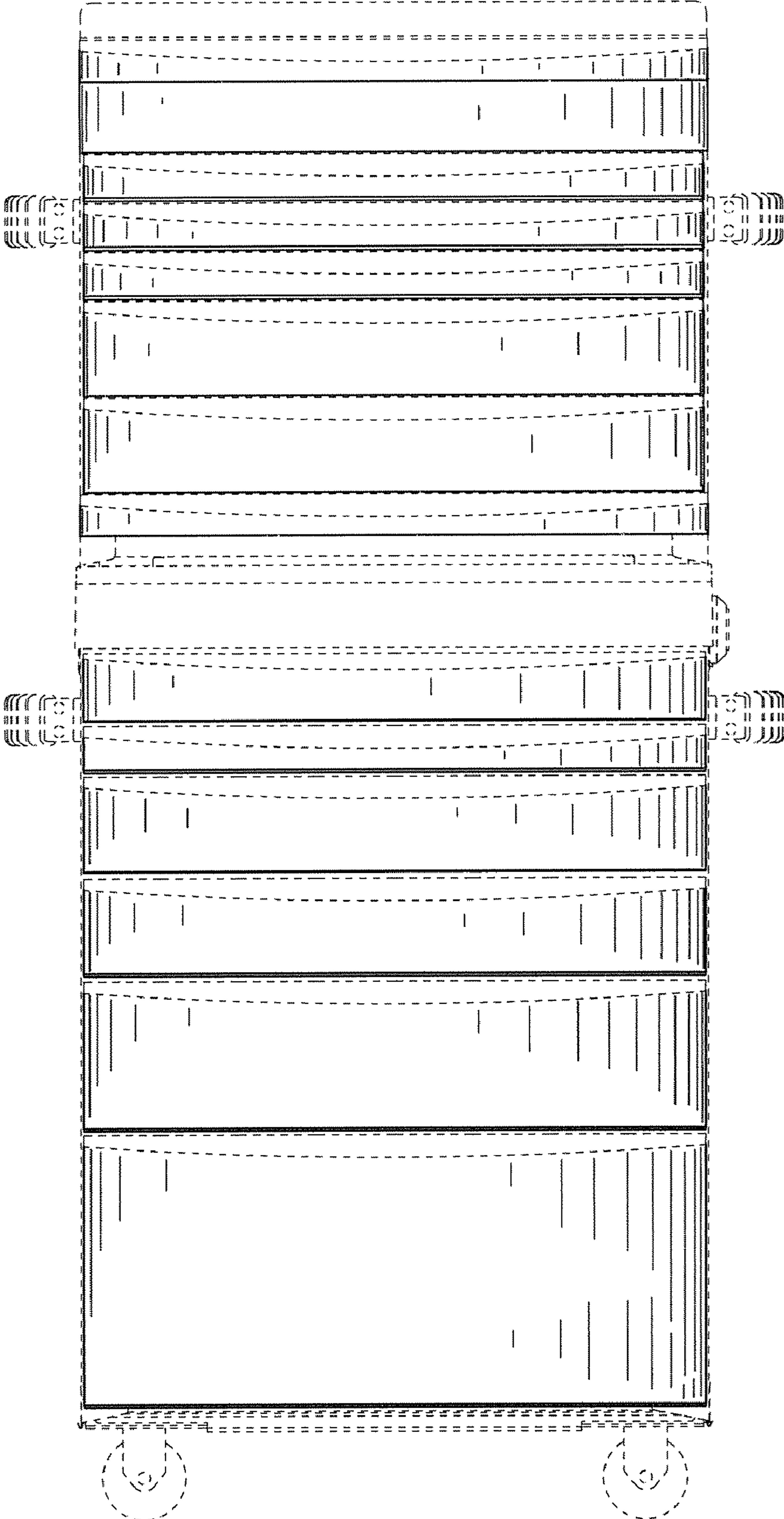

Fig. 2

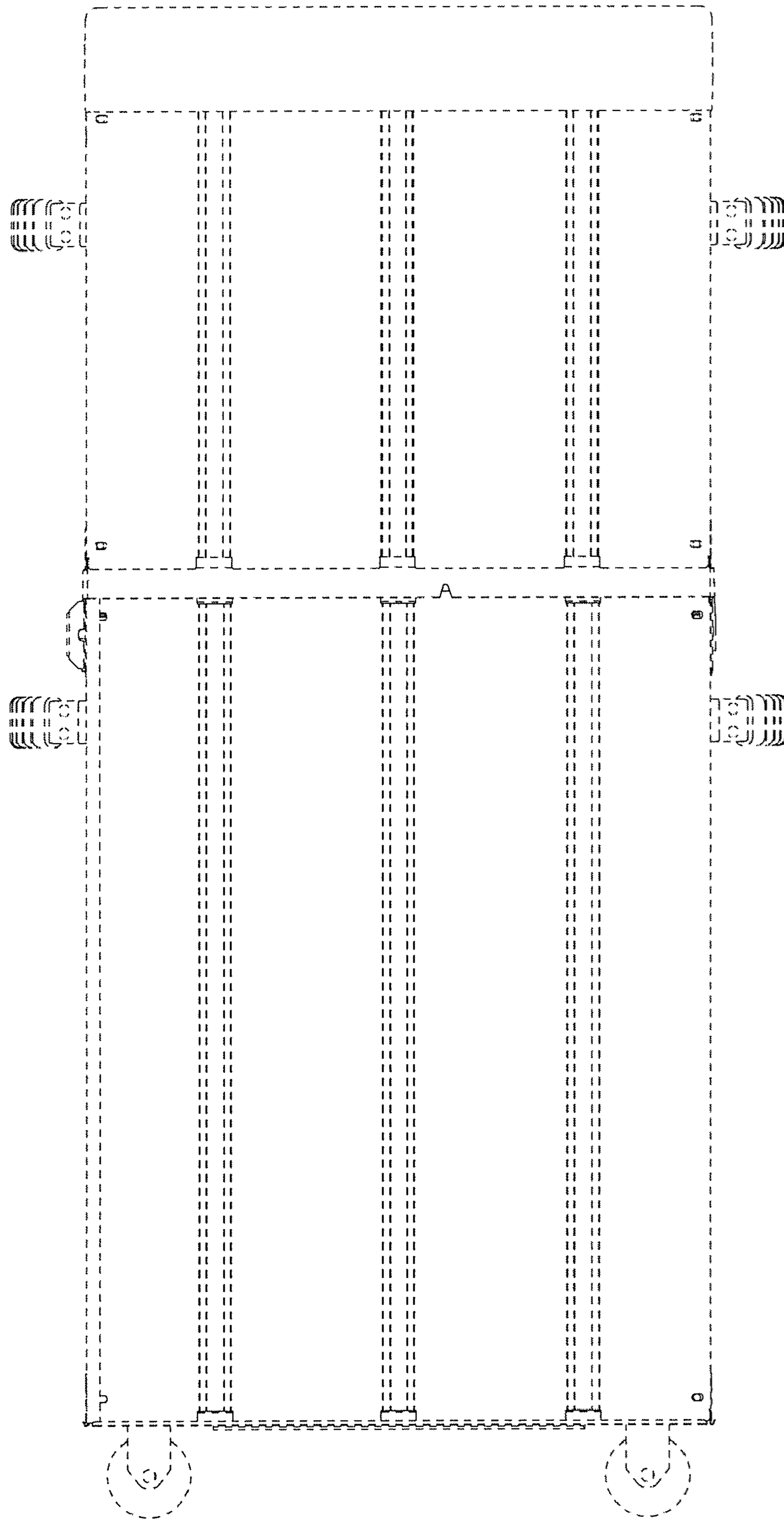

Fig. 3

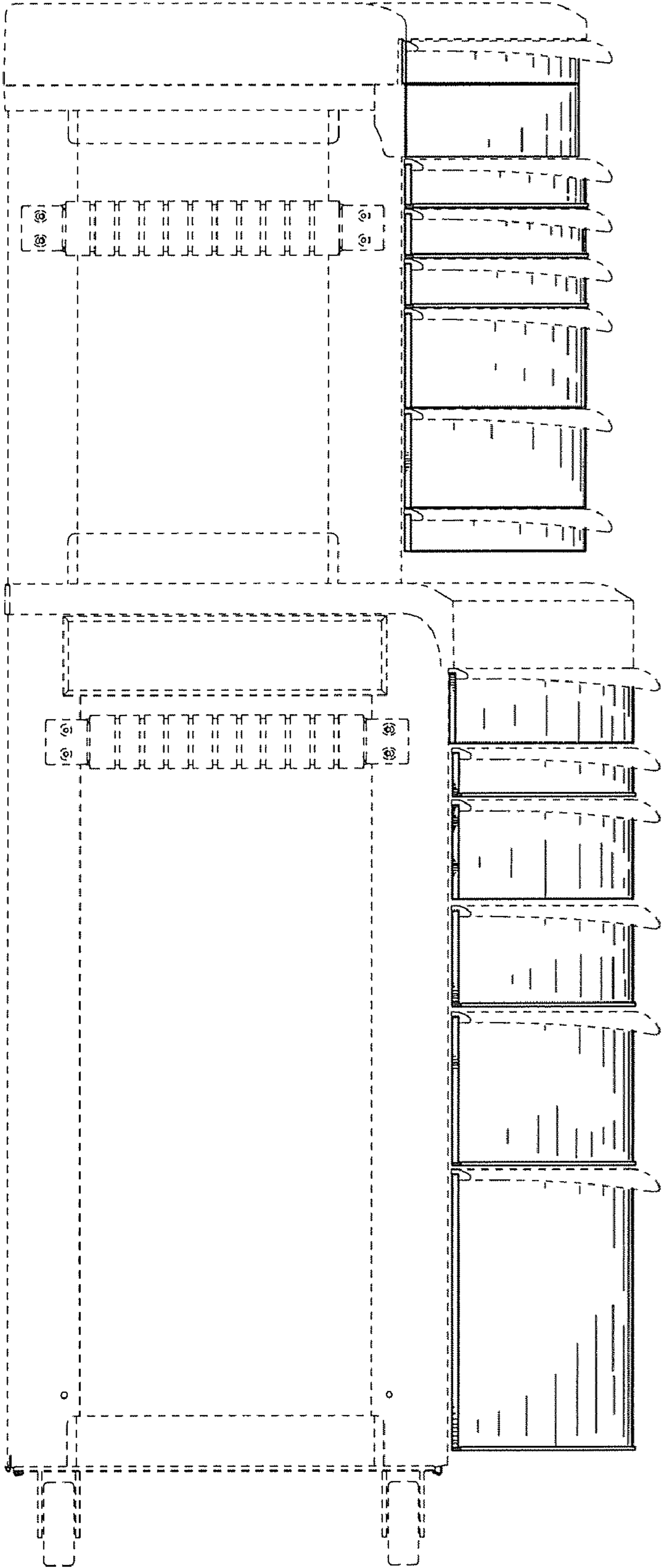

Fig. 4

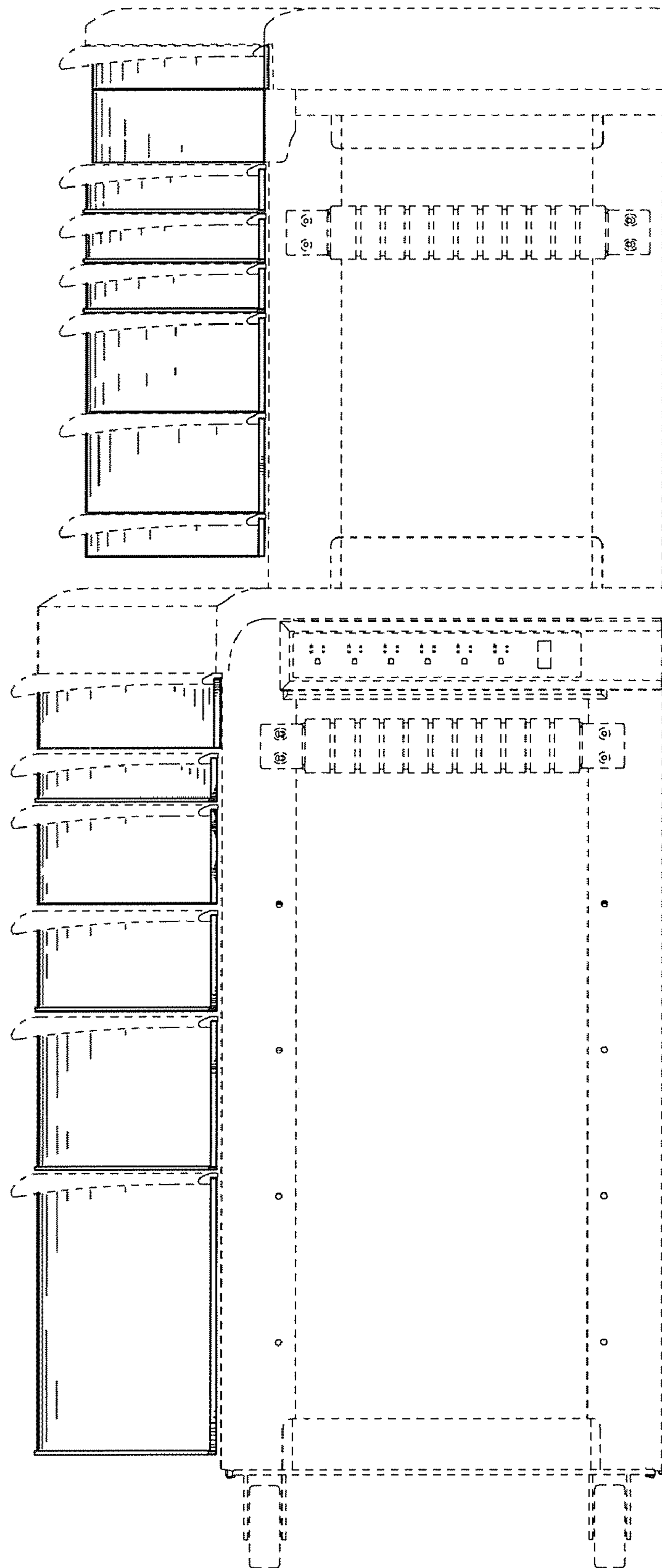

Fig. 5

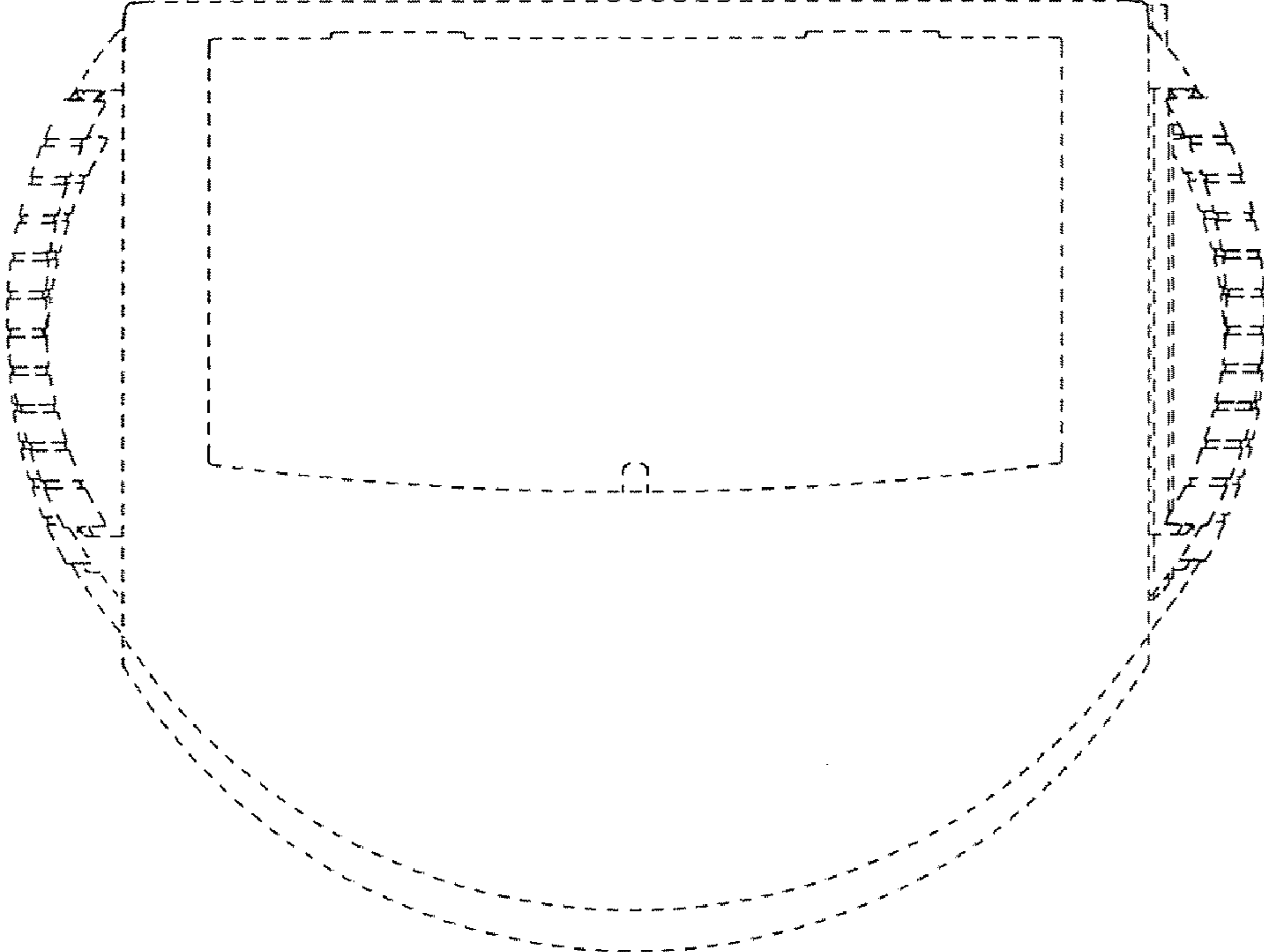

Fig. 6

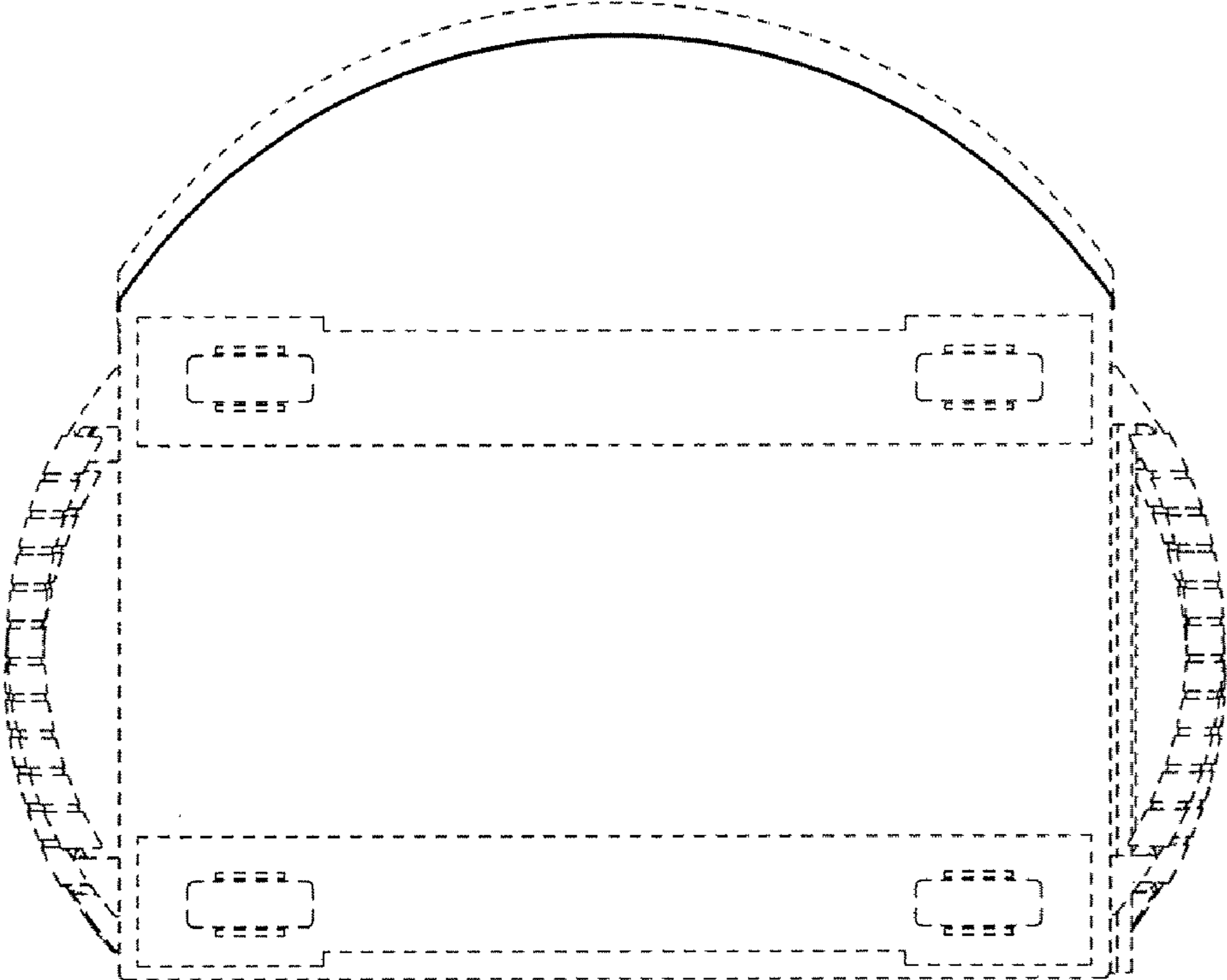

Fig. 7