

US00D563119S

(12) **United States Design Patent**
Malley et al.

(10) **Patent No.:** **US D563,119 S**
(45) **Date of Patent:** **** Mar. 4, 2008**

(54) **TOOL CABINET**

D520,784 S 5/2006 Schmidt et al.
D536,202 S * 2/2007 Mehmen et al. D6/510

(75) Inventors: **John P. Malley**, Cedar Falls, IA (US);
Daniel L. Jackson, Center Point, IA
(US)

* cited by examiner

Primary Examiner—Mimosa De

(73) Assignee: **Waterloo Industries, Inc.**, Waterloo, IA
(US)

(74) *Attorney, Agent, or Firm*—Calfee, Halter & Griswold
LLP

(**) Term: **14 Years**

(57) **CLAIM**

(21) Appl. No.: **29/279,857**

We claim the ornamental design for a tool cabinet, as shown
and described.

(22) Filed: **May 9, 2007**

DESCRIPTION

(51) **LOC (8) Cl.** **06-04**

FIG. 1 is a perspective view of a tool cabinet of the new
design;

(52) **U.S. Cl.** **D6/445**

FIG. 2 is a front elevation view of the tool cabinet of FIG.
1;

(58) **Field of Classification Search** D6/396,
D6/397, 432–448, 510; D3/275, 294–297,
D3/903, 905; 312/107, 117, 125, 204, 209,
312/224, 249.1, 249.11, 249.12, 257.1, 308
See application file for complete search history.

FIG. 3 is a rear view of the tool cabinet of FIG. 1;

FIG. 4 is a left side view of the tool cabinet of FIG. 1;

FIG. 5 is a right side view of the tool cabinet of FIG. 1;

FIG. 6 is a top view of the tool cabinet of FIG. 1; and,

FIG. 7 is a bottom view of the tool cabinet of FIG. 1.

(56) **References Cited**

The portions of the Figures shown in phantom lines form no
part of the claimed design and for illustrative purposes only.

U.S. PATENT DOCUMENTS

- 840,347 A * 1/1907 Knapp 312/224
- D229,262 S * 11/1973 Pearson D6/433
- D430,426 S * 9/2000 Bieker et al. D6/445
- D505,237 S 5/2005 Schmidt et al.
- D514,854 S 2/2006 Schmidt et al.

1 Claim, 6 Drawing Sheets

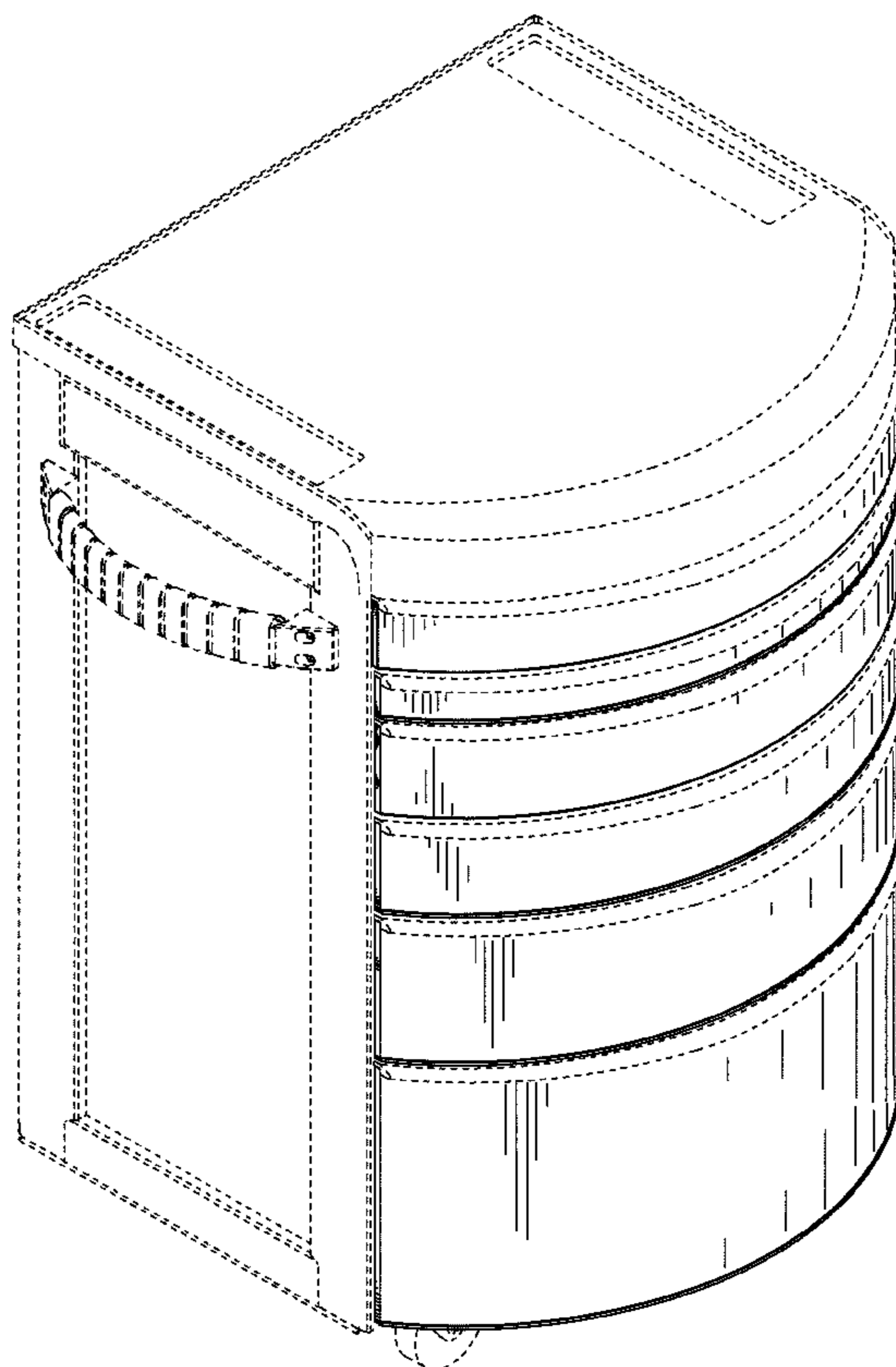

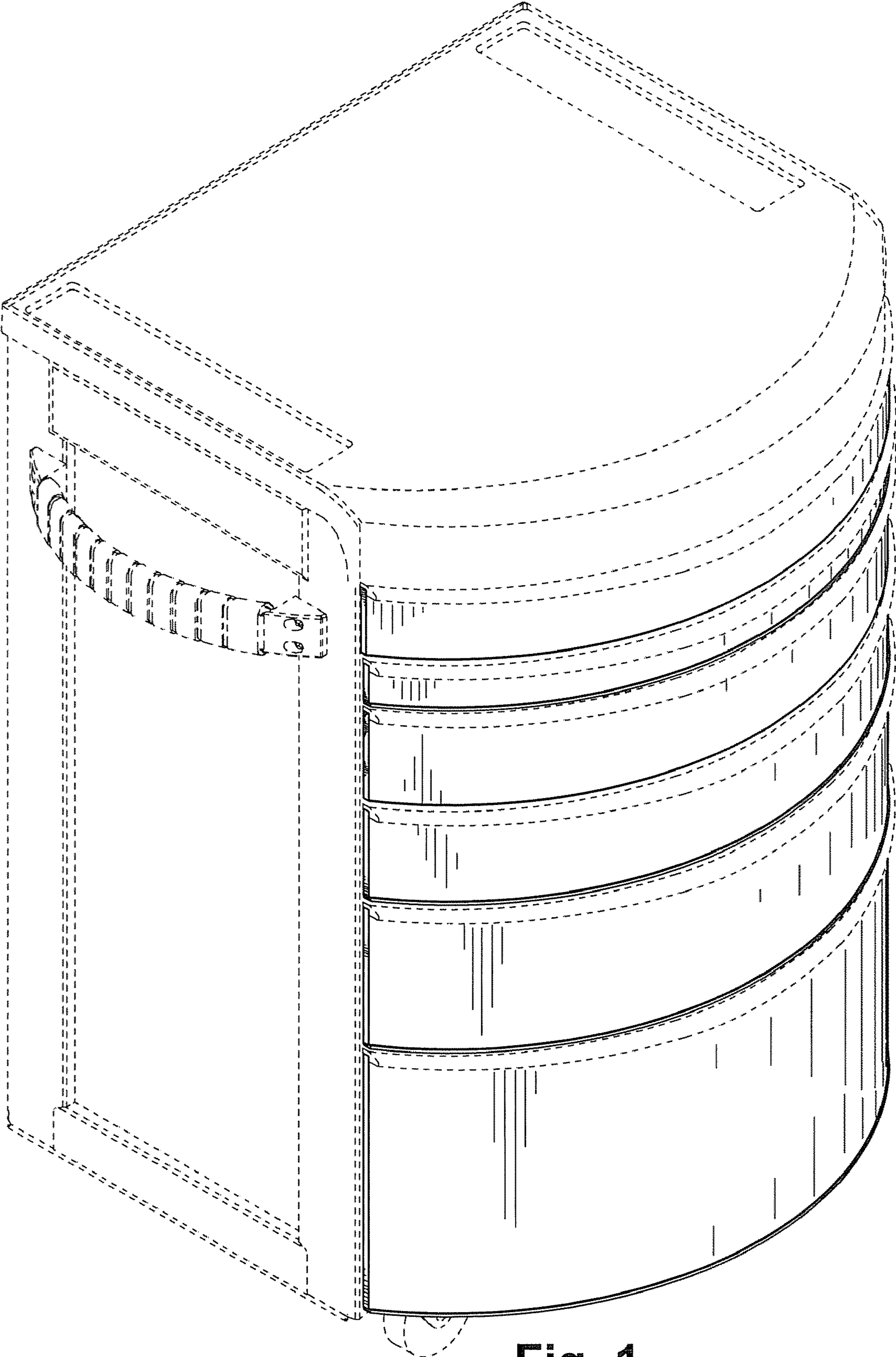

Fig. 1

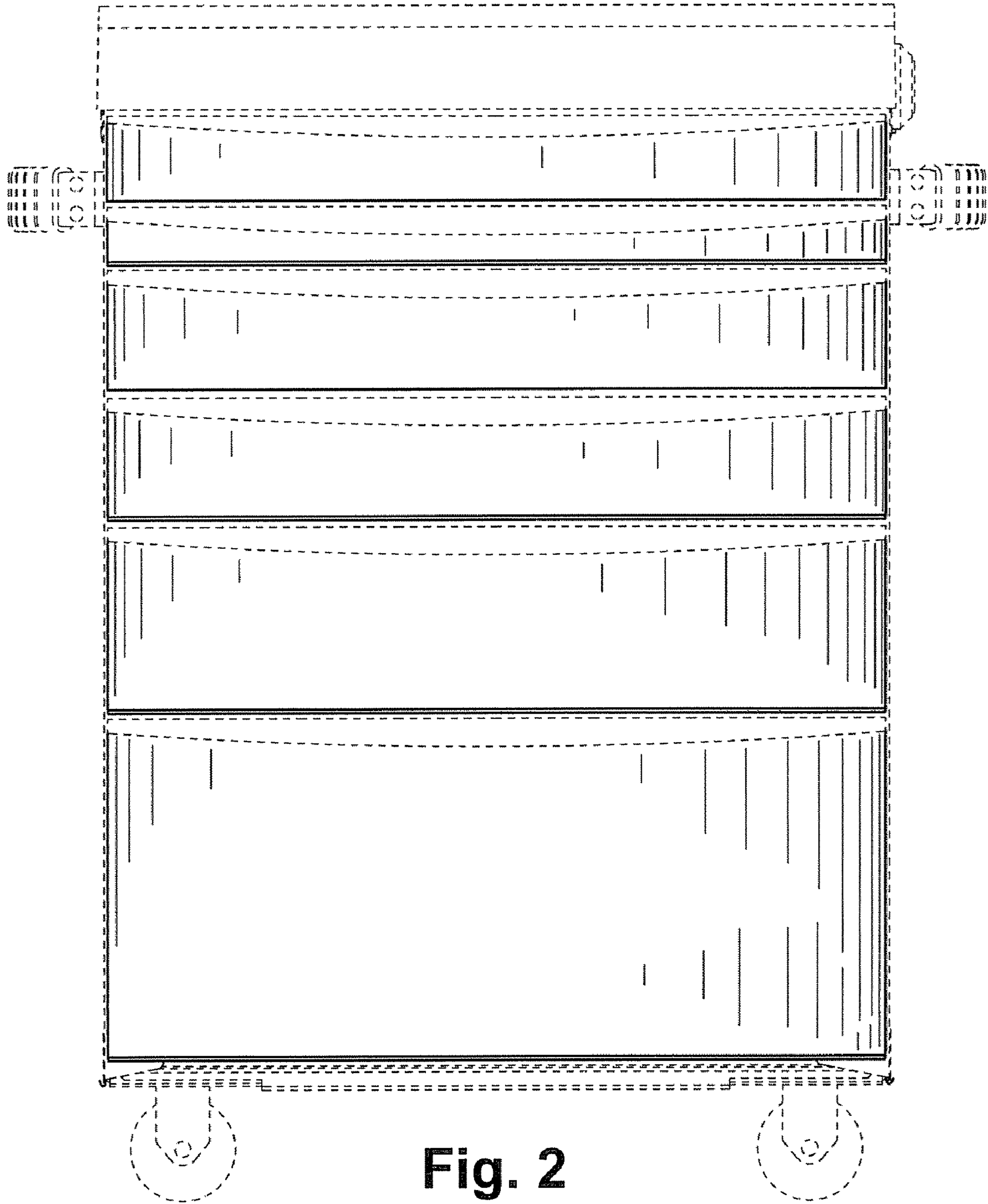

Fig. 2

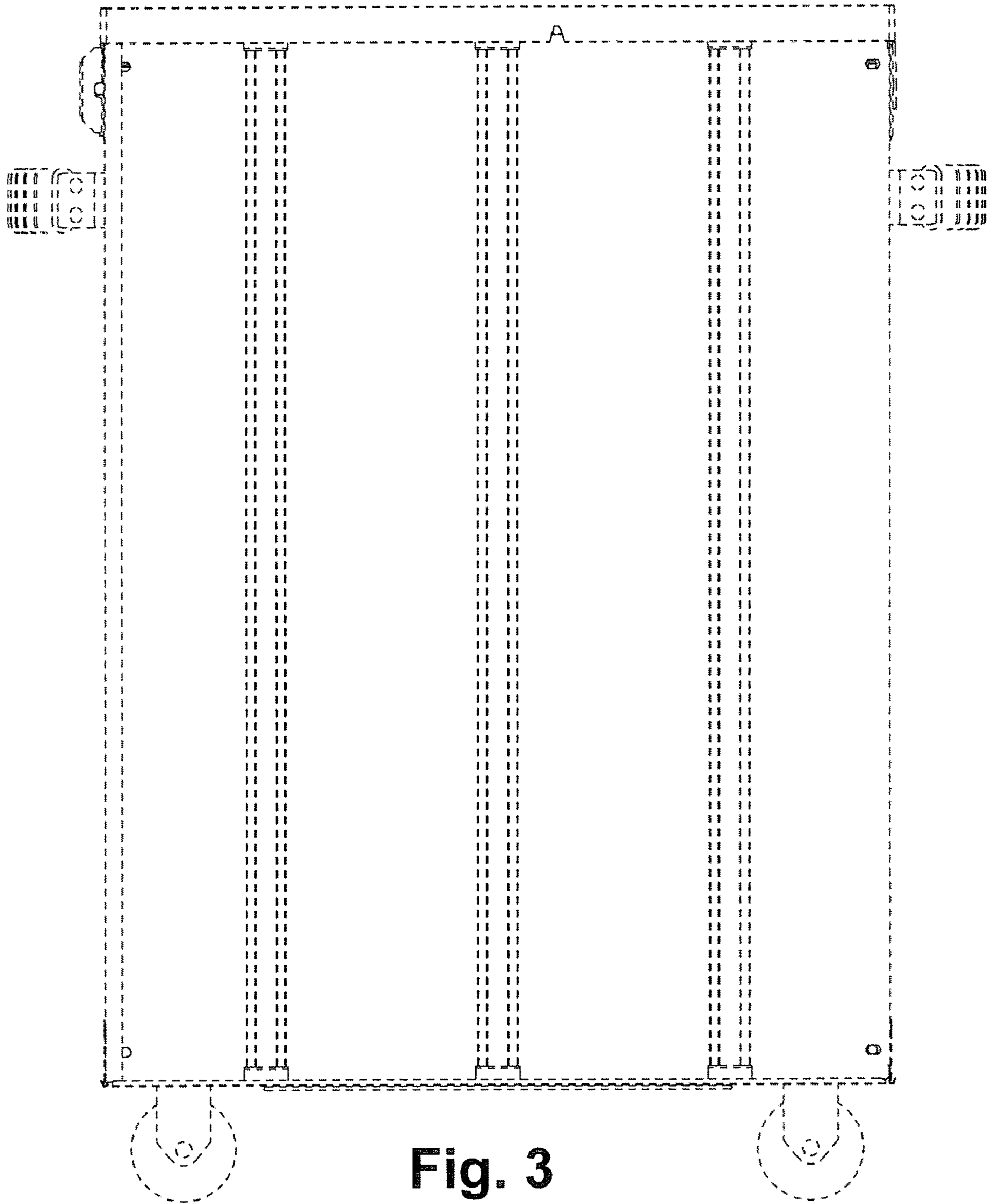

Fig. 3

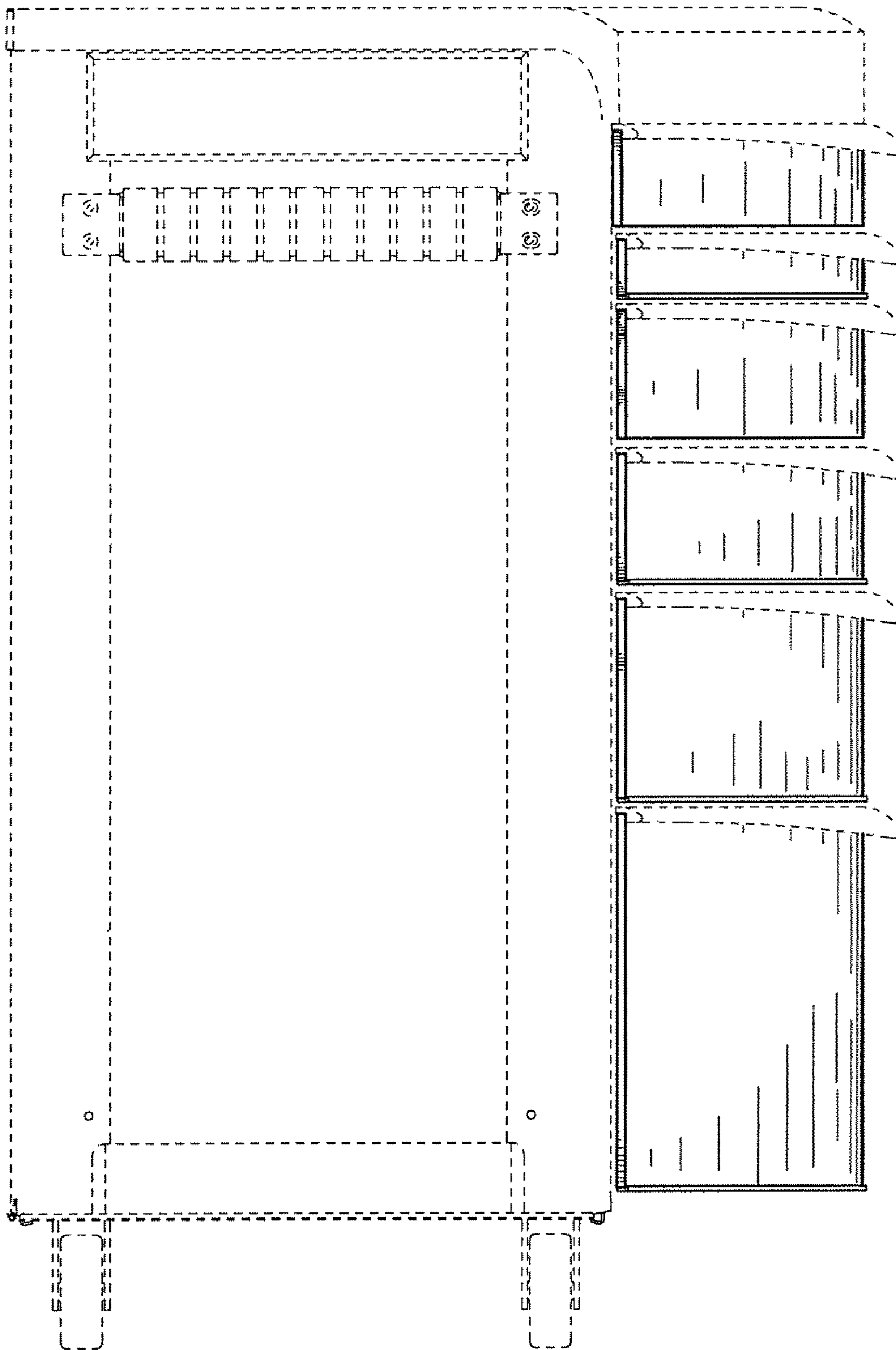

Fig. 4

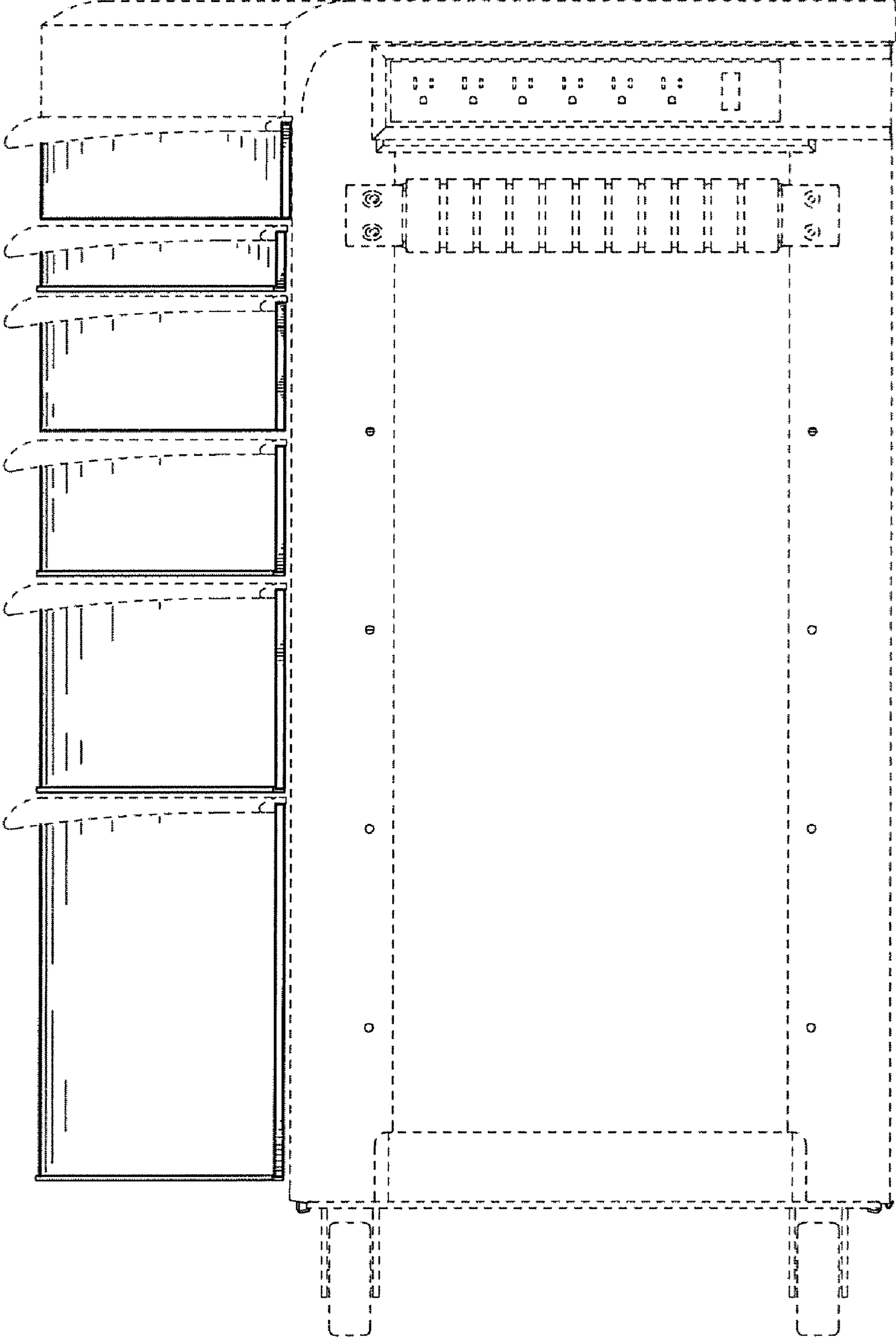

Fig. 5

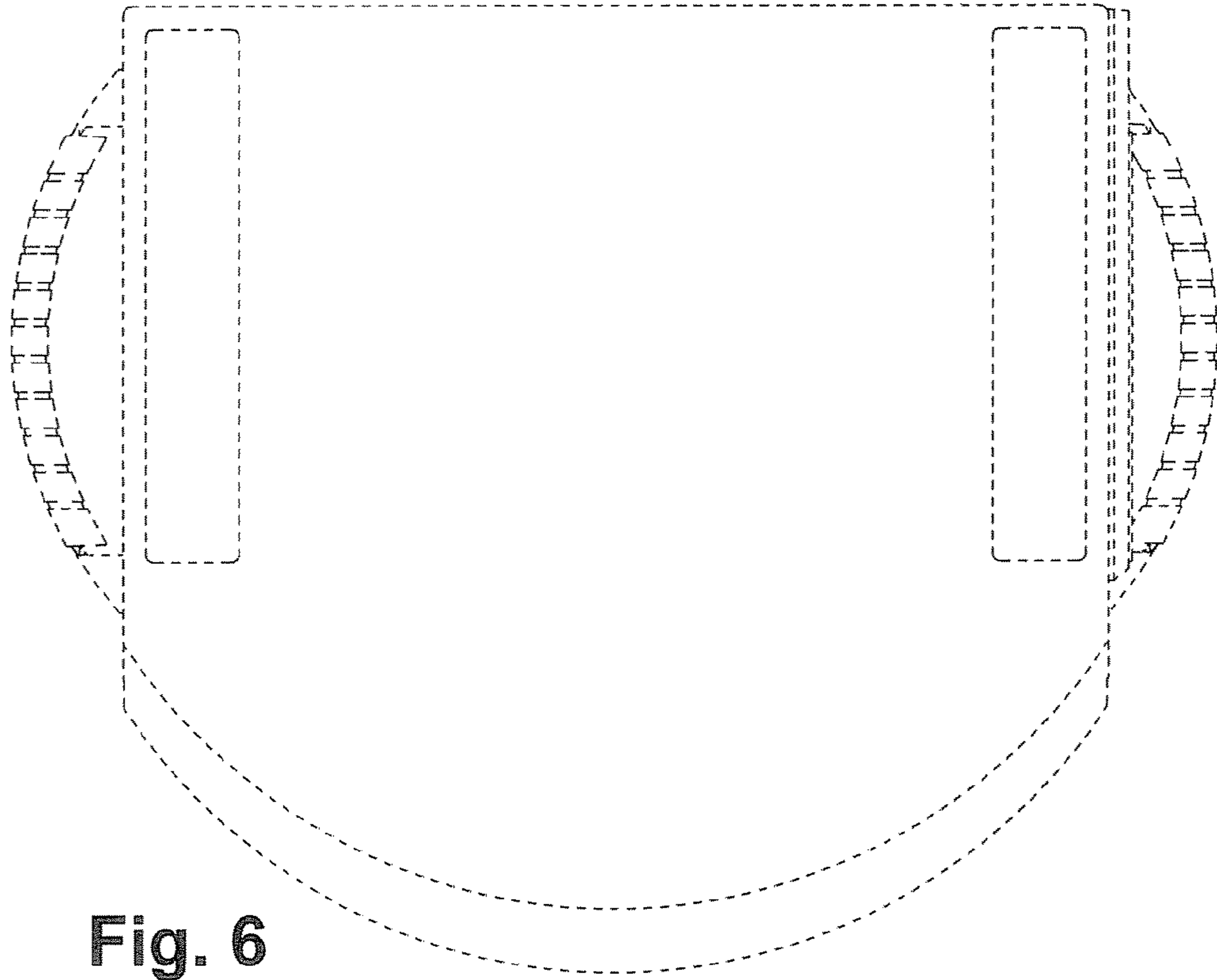

Fig. 6

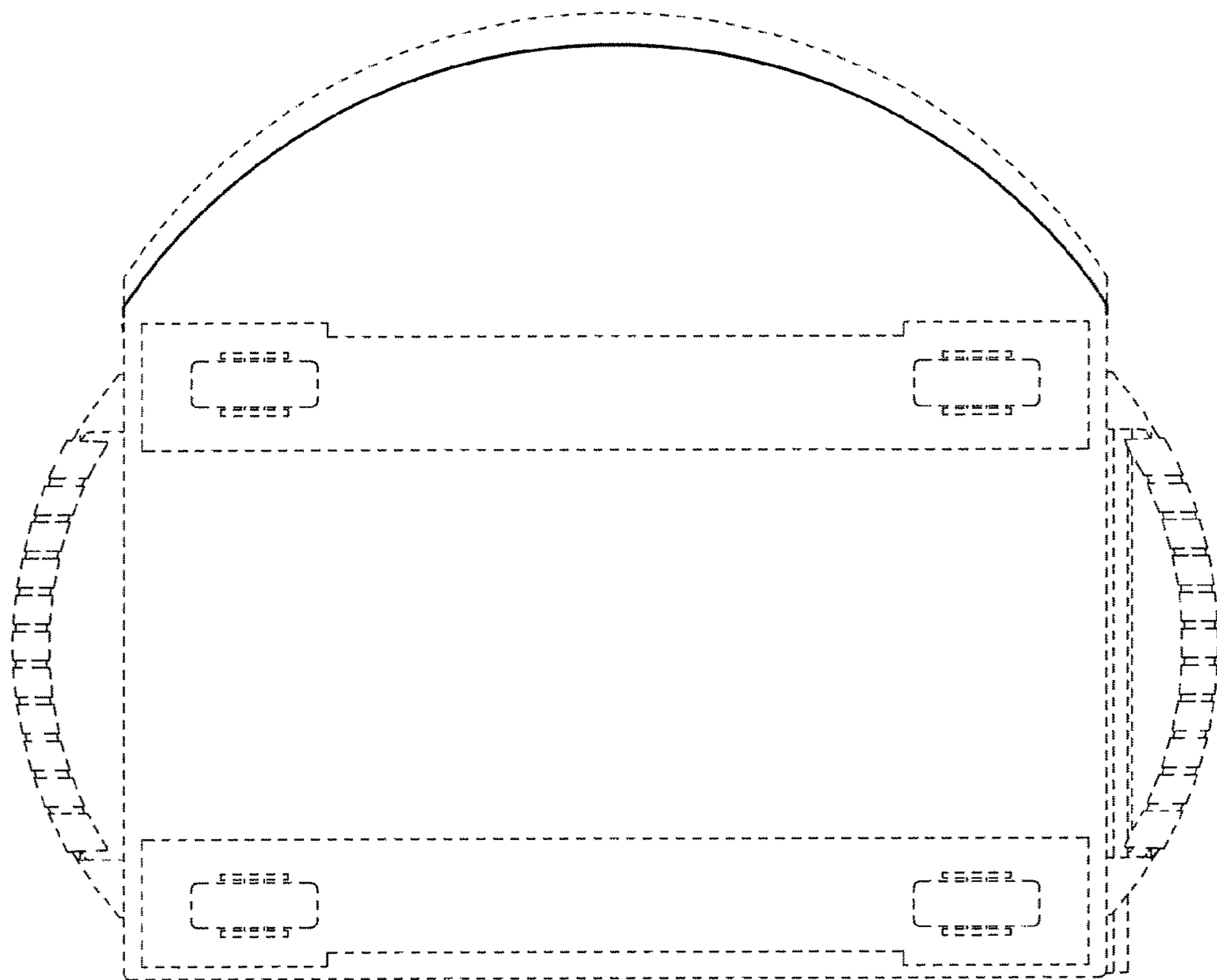

Fig. 7