



US00D563105S

(12) **United States Design Patent**
Rothschild

(10) **Patent No.:** **US D563,105 S**
(45) **Date of Patent:** **** Mar. 4, 2008**

- (54) **STORAGE BIN WITH LID**
- (75) Inventor: **Wayne H. Rothschild**, Northbrook, IL (US)
- (73) Assignee: **International Holdings LLC**, Northfield, IL (US)

- 3,375,008 A 3/1968 Atkinson
- 3,542,569 A 11/1970 Farquhar
- 3,627,541 A 12/1971 Farquhar
- 3,747,832 A 7/1973 Chapman
- 3,976,113 A 8/1976 Kim
- 4,019,675 A 4/1977 Andersson et al.
- 4,091,852 A 5/1978 Jordan et al.
- 4,126,213 A 11/1978 McDonald

(**) Term: **14 Years**

(Continued)

(21) Appl. No.: **29/259,699**

OTHER PUBLICATIONS

(22) Filed: **May 12, 2006**

Foldable Storage Box Small Grey at dwell. Downloaded Jun. 22, 2007 at <http://dwell.co.uk/product.php?prod=102584>.*

Related U.S. Application Data

(Continued)

(63) Continuation-in-part of application No. 11/263,424, filed on Oct. 31, 2005, which is a continuation-in-part of application No. 11/046,423, filed on Jan. 28, 2005.

Primary Examiner—Philip S. Hyder
Assistant Examiner—RoseLynne (Ulm) Cody
(74) *Attorney, Agent, or Firm*—Nixon Peabody LLP

- (51) **LOC (8) Cl.** **03-01**
- (52) **U.S. Cl.** **D3/302; D3/276**
- (58) **Field of Classification Search** D3/201, D3/260, 273, 276, 284–286, 302, 305, 904–905; D7/605, 607; D21/397; 190/1–2, 107; 229/103, 229/117.09, 117.35; 273/285–286; 383/4, 383/6, 40, 97, 110
See application file for complete search history.

(57) **CLAIM**

The ornamental design for a storage bin with lid, as shown and described.

DESCRIPTION

FIG. 1 is a perspective view of a storage bin and lid showing my new design.

FIG. 2 is an exploded perspective view of the storage bin and lid shown in FIG. 1 with the lid removed from the storage bin.

FIG. 3 is a top view of the storage bin and lid shown in FIG. 1.

FIG. 4 is a bottom view of the storage bin and lid shown in FIG. 1.

FIG. 5 is a side view of the storage bin and lid shown in FIG. 1; the opposite side being a mirror image thereof; and,

FIG. 6 is an end view of the storage bin and lid shown in FIG. 1; the opposite end being a mirror image thereof.

All broken lines shown are for illustrative purposes only and form no part of the claimed design.

(56) **References Cited**

U.S. PATENT DOCUMENTS

- 170,991 A 12/1875 Conover
- 1,269,276 A 6/1918 Harris
- 1,365,831 A 1/1921 Hyatt
- 1,467,690 A 9/1923 Schwarz
- 1,985,111 A 12/1934 Shofer et al.
- 2,085,038 A * 6/1937 Perretton 229/103
- 2,105,953 A 1/1938 Quellette
- 2,479,203 A 8/1949 Brown
- 2,636,313 A 4/1953 Shank
- 2,768,719 A * 10/1956 Morris et al. 190/107
- 2,831,624 A 4/1958 Lever
- 3,044,211 A 7/1962 Palm
- 3,097,782 A 7/1963 Koropatkin et al.
- 3,262,283 A 7/1966 Taylor

1 Claim, 6 Drawing Sheets

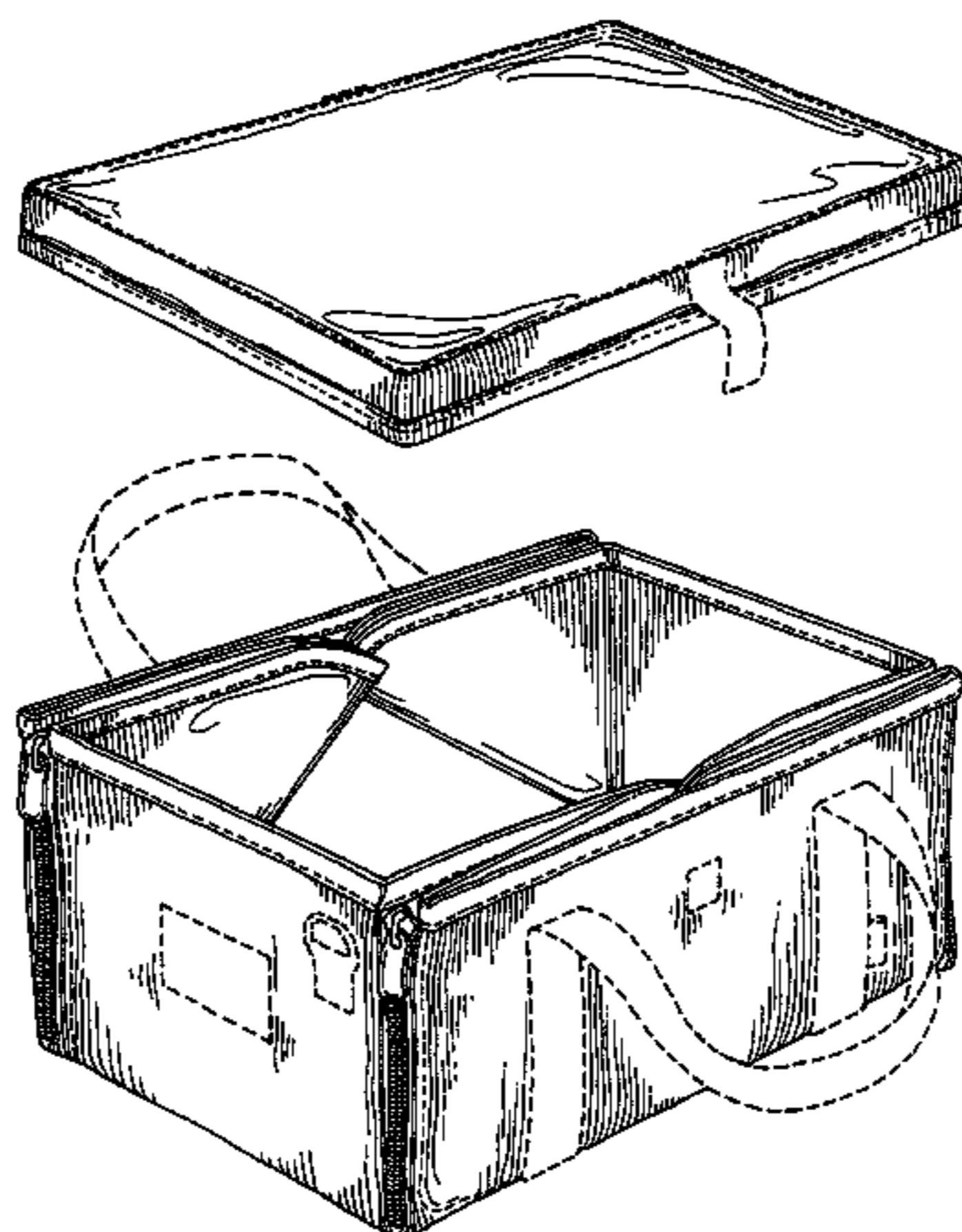

U.S. PATENT DOCUMENTS

4,199,097 A 4/1980 Christenson
 4,206,868 A 6/1980 Stephens
 4,306,658 A 12/1981 Montealegre
 4,340,169 A 7/1982 Webinger
 4,375,111 A 3/1983 Hall
 4,451,001 A 5/1984 Webinger
 4,489,815 A * 12/1984 Martinez et al. 190/1
 4,661,195 A 4/1987 Hopson
 4,681,195 A 7/1987 Trahan et al.
 4,712,673 A 12/1987 Moore
 4,738,545 A 4/1988 Westgor
 4,765,533 A 8/1988 Hoshiko et al.
 4,791,883 A 12/1988 Lehman et al.
 4,930,680 A 6/1990 Hanus
 4,984,906 A * 1/1991 Little 383/4
 5,016,813 A 5/1991 Simons
 5,033,668 A 7/1991 Cohen et al.
 5,035,013 A 7/1991 Bloom
 5,088,139 A 2/1992 Bloom
 5,100,151 A * 3/1992 Lyon et al. 273/285
 5,136,738 A 8/1992 Denson
 5,207,376 A 5/1993 Cohen et al.
 5,255,841 A 10/1993 Ritter
 5,294,040 A 3/1994 Cohen et al.
 5,370,460 A 12/1994 Nelson
 5,630,543 A 5/1997 Dugan
 5,788,350 A 8/1998 Fladung
 5,853,121 A 12/1998 Francisco
 5,904,230 A * 5/1999 Peterson 190/107
 6,048,249 A 4/2000 Vandenberg
 6,050,483 A 4/2000 Haraldsson et al.
 6,053,634 A 4/2000 Kay
 6,059,179 A 5/2000 Giampapa
 6,079,616 A 6/2000 Chinks et al.
 6,146,238 A 11/2000 Daiber
 D435,342 S 12/2000 Mogil
 D435,968 S 1/2001 Mogil
 D436,442 S 1/2001 Mogil
 6,203,017 B1 * 3/2001 Schultz 273/285
 6,247,328 B1 6/2001 Mogil
 6,523,989 B2 2/2003 Carty
 6,572,436 B1 6/2003 So

6,663,459 B2 12/2003 Ostolaza
 6,676,010 B1 1/2004 Roseth et al.
 6,736,309 B1 5/2004 Westerman et al.
 D493,618 S * 8/2004 DeCarlo et al. D3/302
 D494,758 S * 8/2004 DeCarlo et al. D3/302
 D500,205 S * 12/2004 DeCarlo et al. D3/302
 D510,189 S * 10/2005 Greiner D3/295
 D518,637 S * 4/2006 DeCarlo et al. D3/302
 7,044,277 B2 * 5/2006 Redzisz 190/107
 7,143,932 B2 * 12/2006 Wang 229/117.35
 7,188,713 B1 * 3/2007 Espar et al. 190/2
 2006/0177154 A1 * 8/2006 Morrissey, Jr. 383/4

OTHER PUBLICATIONS

Information brochure from Homegrown Kids—Toy Taco www.toydirectory.com/monthly/toyfairpreview/Homegrown/index.asp; 1 page.
 Information brochure from Parents of Innovation—Romp'n Run www.parentsofinnovation.com/home.html; 1 page.
 Information brochure from Homegrown Kids—Activity Cooler www.toydirectory.com/monthly/toyfairpreview/Homegrown/index.asp; 1 page.
 Photo image from Parentsoup—Manicure Lap Desk www.parentsoup.com/specialevents/holiday2004/photo/0..654798.655903.00.html; 1 page.
 Photographs of packaging and Product—Marshmallow—Create-A-Room—School Bus Autobus; (Apr. 2005); 9 pages.
 Photographs of packaging and product—Worlds Apart—Ready Room™ Collection—Pack & Playmates Truck; (Apr. 2005); 8 pages.
 Photographs of packaging and product—Worlds Apart—Ready Room™ Collection—Pack & Playmates Cottage; (Apr. 2005); 18 pages.
 Photographs of packaging and product—Worlds Apart—Ready Room™ Fold-away soft storage—Pack & Playmates Fire Truck; (Apr. 2005); 11 pages.
 Toys Et Cetera Fall 2005 Catalog Description of a Play Mat (printed from the Internet on Oct. 4, 2005); 1 page.
 Product Information Sheet for Clink-Proof 6-Pack Wetsuit: Flat Lunch Pack Tote; Herrington Catalog.com, “Wetsuit for 6-Packs Gives You A Clink-Proof Way To BYOB!” 2 page (printed from the Internet on Dec. 6, 2005).

* cited by examiner

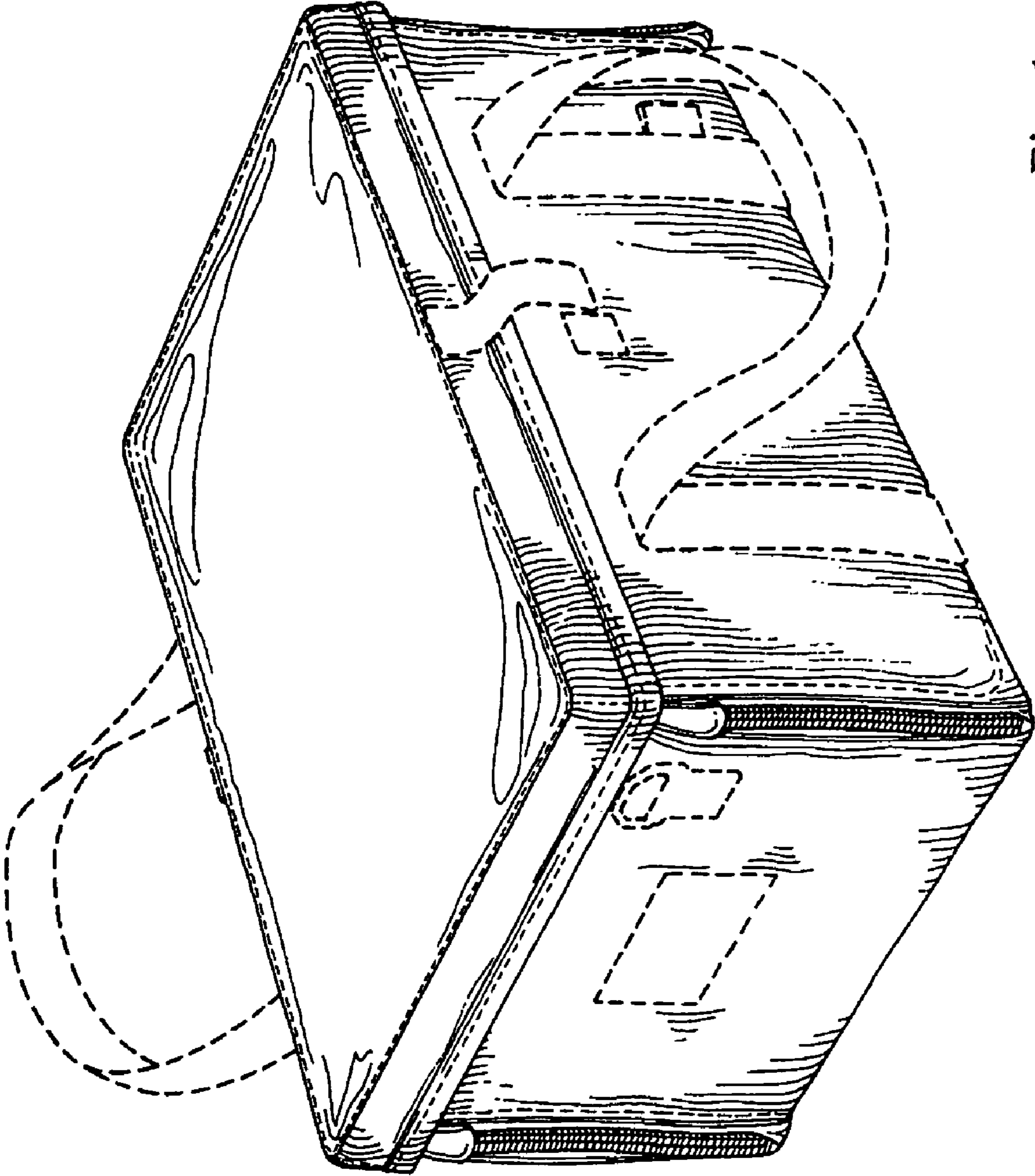

Fig. 1

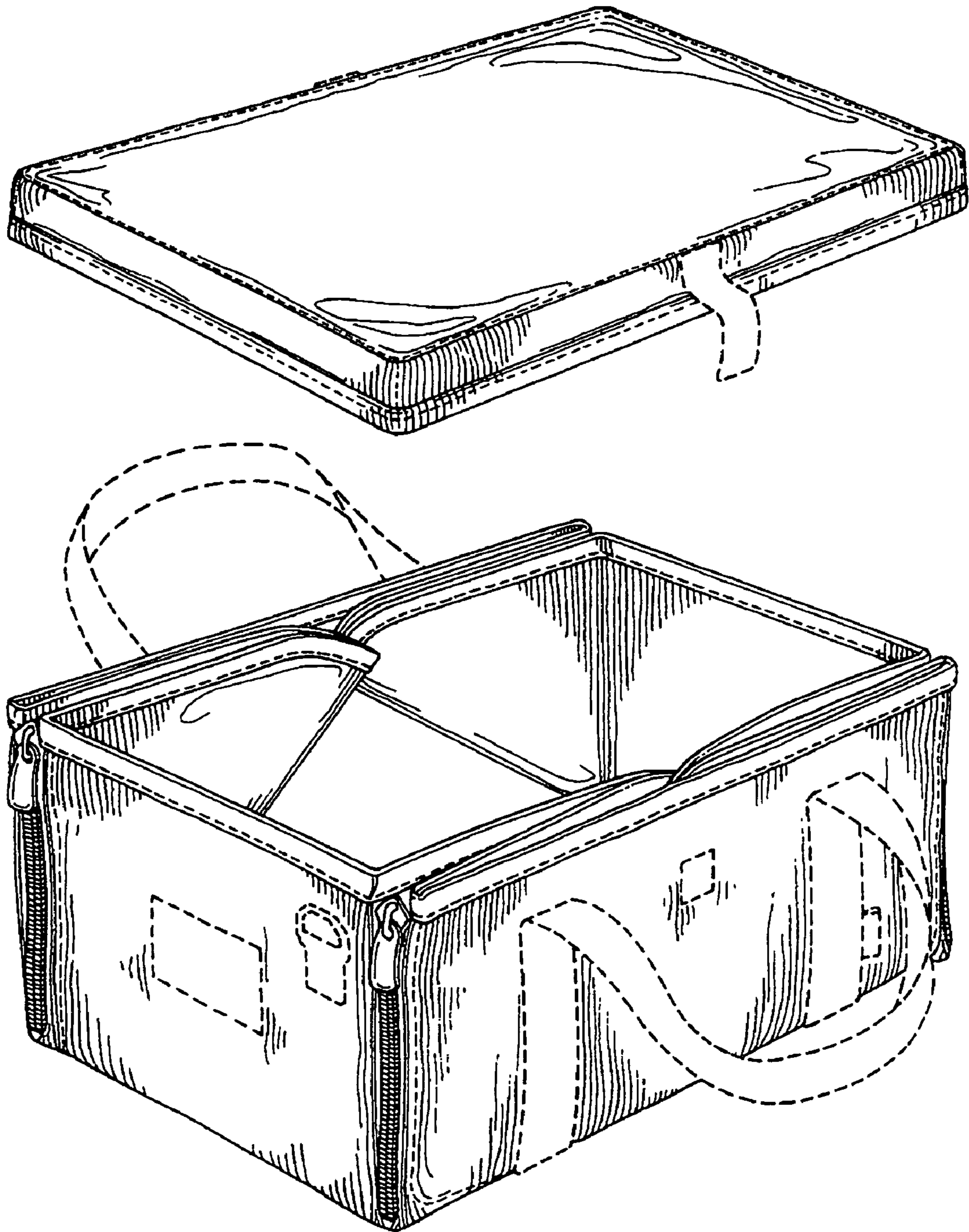

Fig. 2

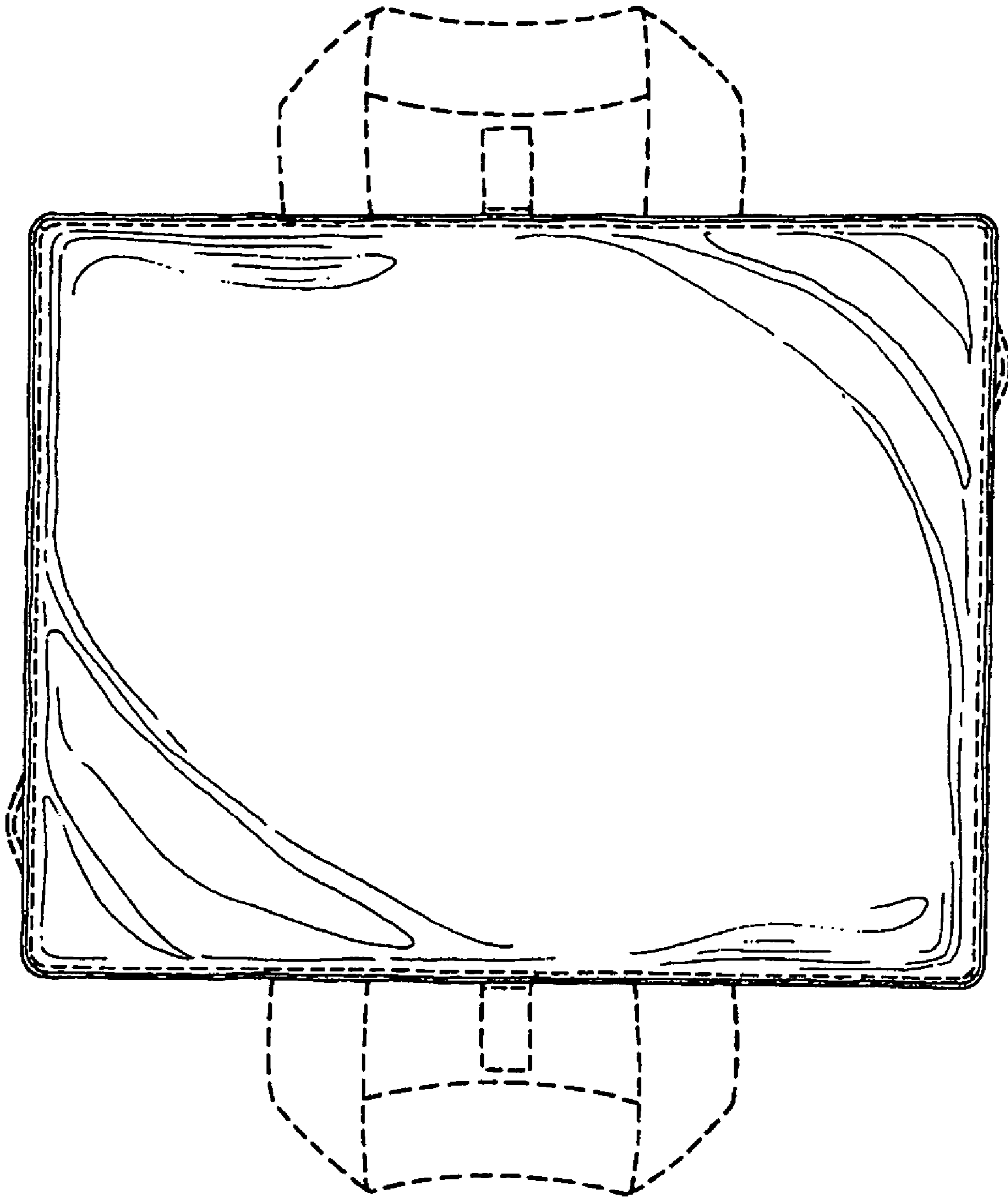

Fig. 3

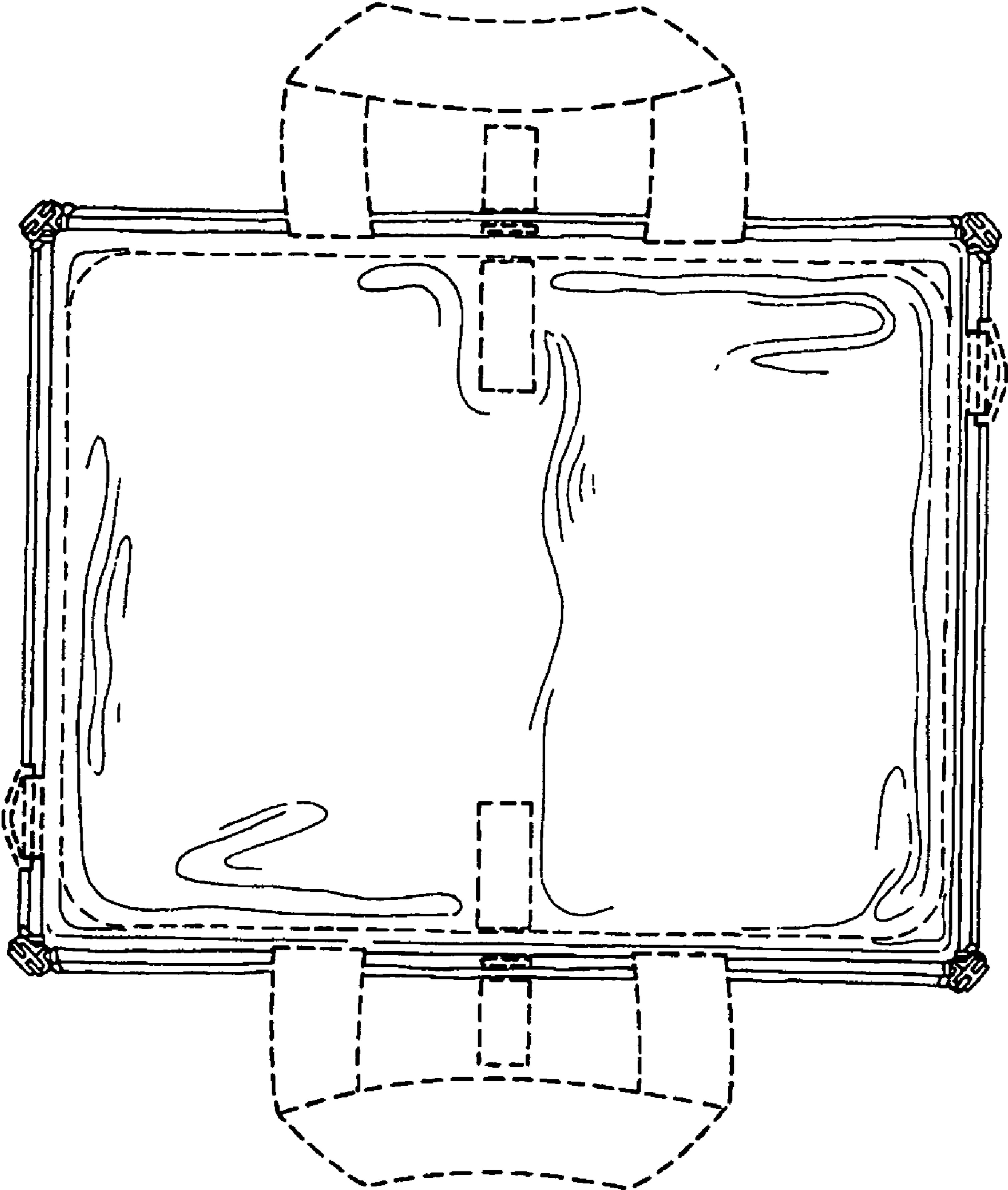

Fig. 4

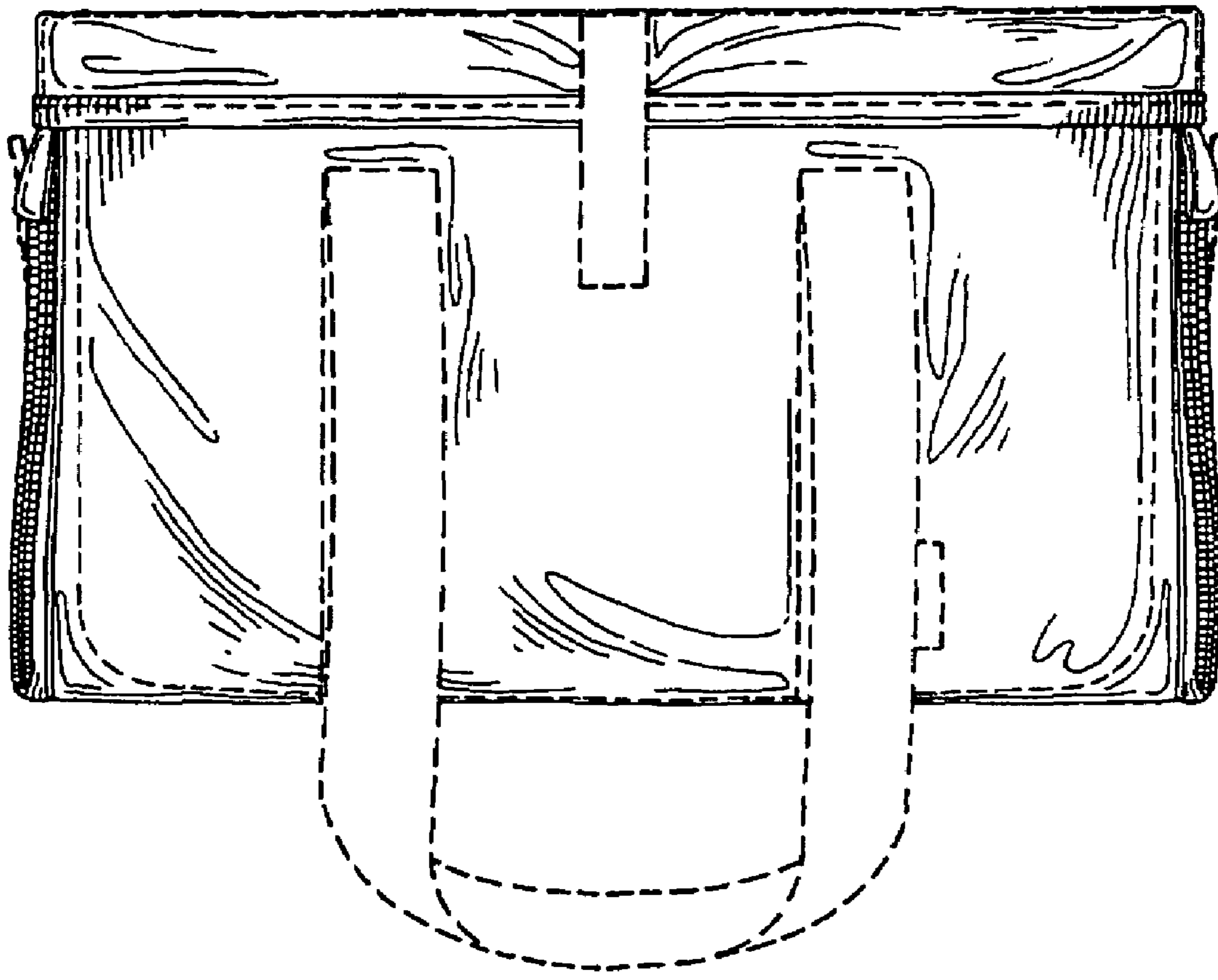

Fig. 5

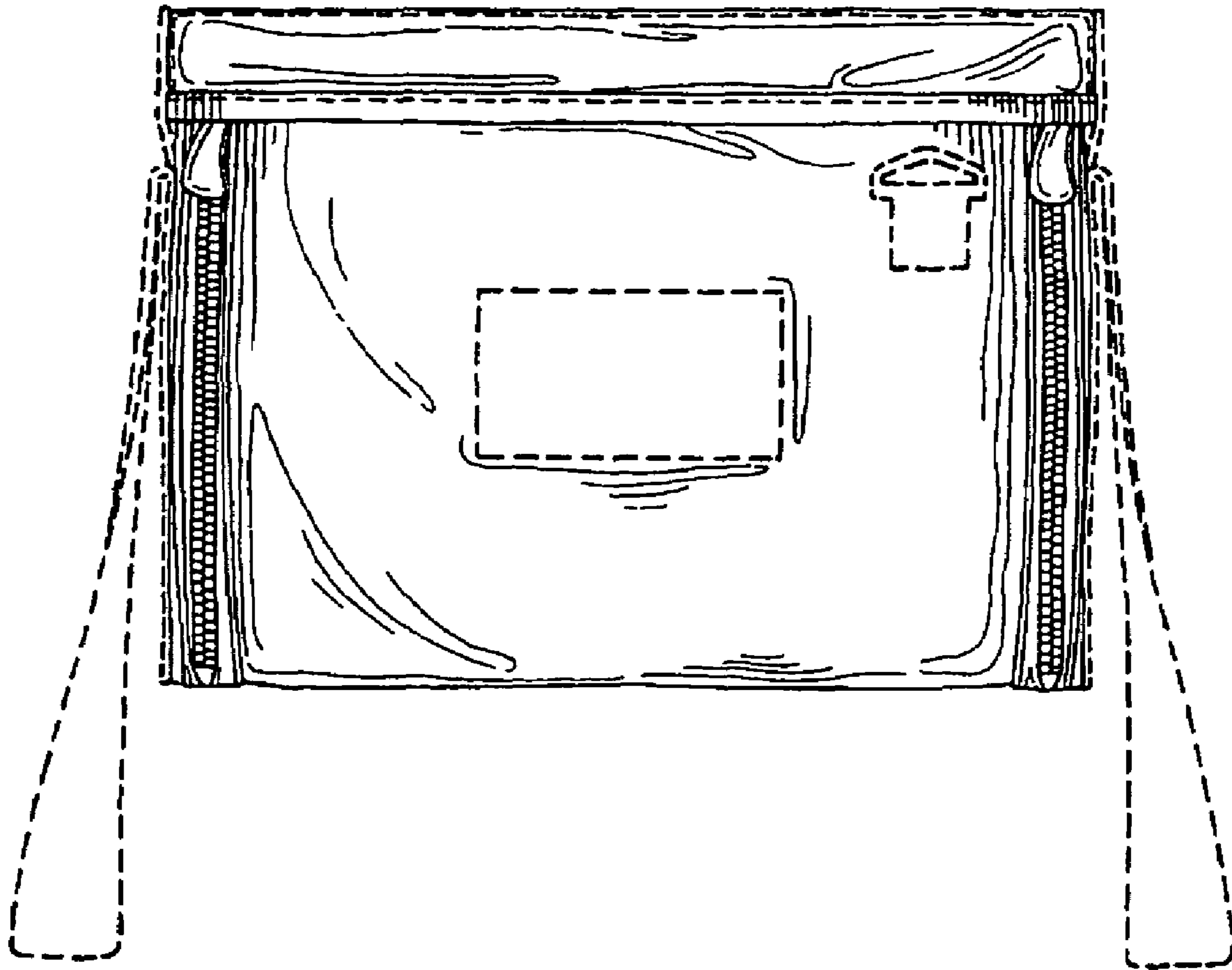

Fig. 6