



US00D563102S

(12) **United States Design Patent**
Cornwell et al.

(10) **Patent No.:** **US D563,102 S**
(45) **Date of Patent:** **** Mar. 4, 2008**

- (54) **TOOL CARRYING CASE WITH TRANSPARENT COVER**
- (75) Inventors: **W Robert Cornwell**, Ronan, MT (US);
Nathan C Cantlon, Charlo, MT (US)
- (73) Assignee: **Jore Corporation**, Pasco, WA (US)
- (**) Term: **14 Years**
- (21) Appl. No.: **29/266,679**
- (22) Filed: **Sep. 25, 2006**

- (51) **LOC (8) Cl.** **03-01**
- (52) **U.S. Cl.** **D3/294; D3/905**
- (58) **Field of Classification Search** **D3/273-274,**
D3/276, 281-282, 292, 294-295, 302, 905;
D9/418, 420, 423-424; 206/349, 372-373;
220/4.21-4.22

See application file for complete search history.

(56) **References Cited**

U.S. PATENT DOCUMENTS

D290,344 S *	6/1987	Toms	D9/424
D303,583 S *	9/1989	Bakic	D28/83
D310,563 S *	9/1990	Greengrass et al.	D3/203.1
D361,035 S *	8/1995	Krupa	D9/424
D361,715 S *	8/1995	Hauptert	D9/424
D367,557 S *	3/1996	Chang	D3/276
D382,115 S *	8/1997	Chang	D3/282
5,782,351 A *	7/1998	Shoptaugh	206/315.1
D419,768 S *	2/2000	Richardson et al.	D3/273
D431,359 S *	10/2000	Lapidus	D3/273
D436,441 S *	1/2001	Lapidus	D3/273
6,213,296 B1 *	4/2001	Streich et al.	206/373
D458,840 S *	6/2002	Lai	D3/295
D459,223 S *	6/2002	Lai	D3/295
6,405,864 B1 *	6/2002	Streich et al.	206/373
D464,196 S *	10/2002	Parker	D3/273
D465,330 S *	11/2002	Parker	D3/273
D466,296 S *	12/2002	Hellenberg-Hubar	D3/295

D474,340 S *	5/2003	Vasudeva	D3/282
D475,853 S *	6/2003	Chen	D3/294
D477,912 S *	8/2003	Cunningham et al.	D3/273
D481,868 S *	11/2003	Cunningham et al.	D3/273
6,755,302 B1 *	6/2004	Streich et al.	206/373
D502,316 S *	3/2005	Chen	D3/273
D522,746 S *	6/2006	Perella et al.	D3/276
D527,523 S *	9/2006	Cornwell et al.	D3/294
D528,793 S *	9/2006	Cornwell et al.	D3/294
D541,685 S *	5/2007	Bradford	D10/78
D548,971 S *	8/2007	Lin	D3/294
2002/0043534 A1 *	4/2002	Uke	220/4.21

* cited by examiner

Primary Examiner—Philip S. Hyder
Assistant Examiner—RoseLynne (Ulm) Cody
 (74) *Attorney, Agent, or Firm*—Christensen O'Connor Johnson Kindness PLLC

(57) **CLAIM**

The ornamental design for a tool carrying case with transparent cover, as shown.

DESCRIPTION

FIG. 1 is an isometric view of a tool carrying case with transparent cover, showing a first side;
 FIG. 2 is an isometric view of the tool carrying case with transparent cover of FIG. 1, showing a second side;
 FIG. 3 is a top plan view thereof;
 FIG. 4 is a bottom plan view thereof;
 FIG. 5 is a side elevation view thereof, showing the first side;
 FIG. 6 is a side elevation view thereof, showing the second side;
 FIG. 7 is an end elevation view thereof; and,
 FIG. 8 is a second end elevation view thereof.

1 Claim, 5 Drawing Sheets

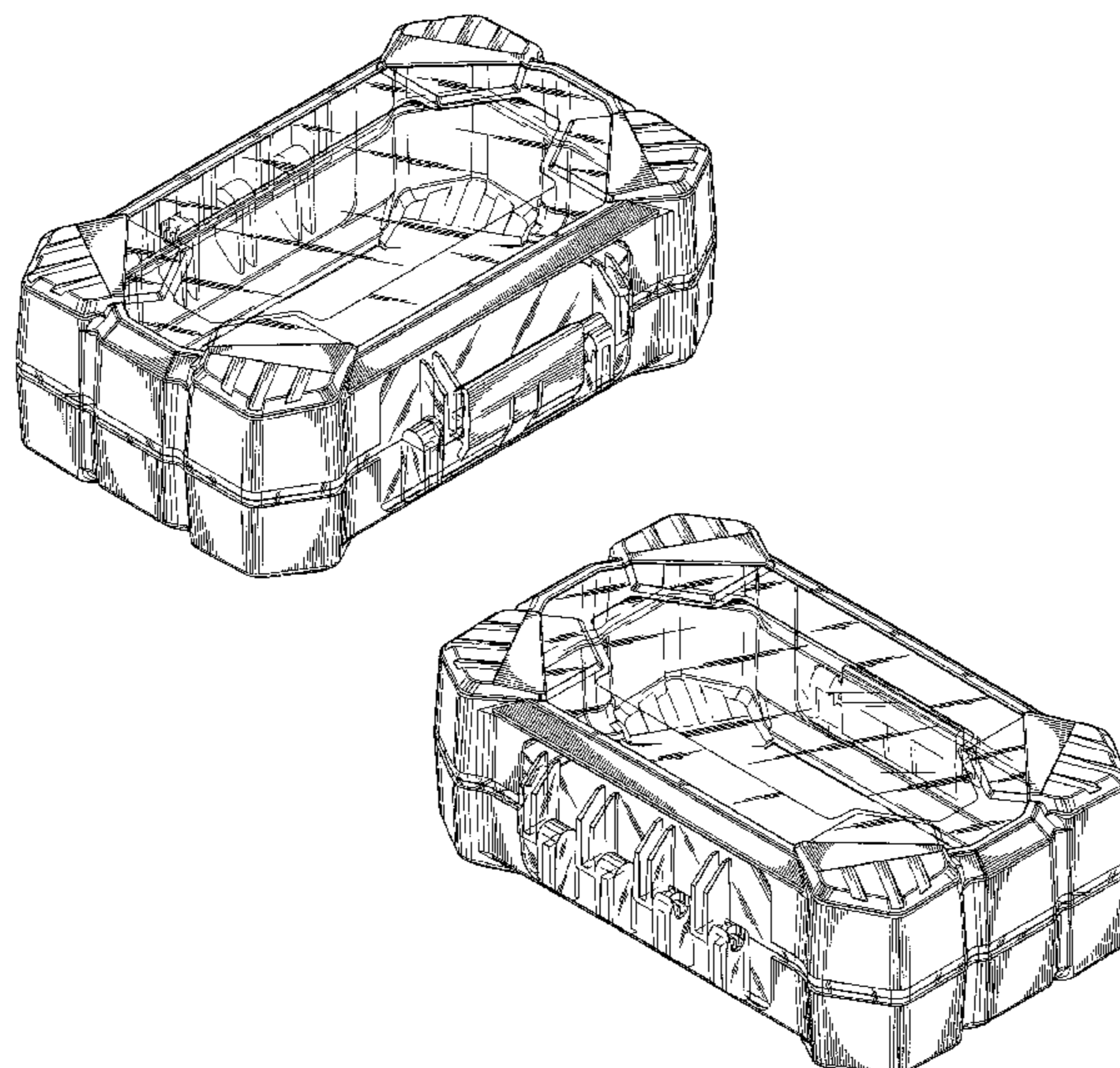

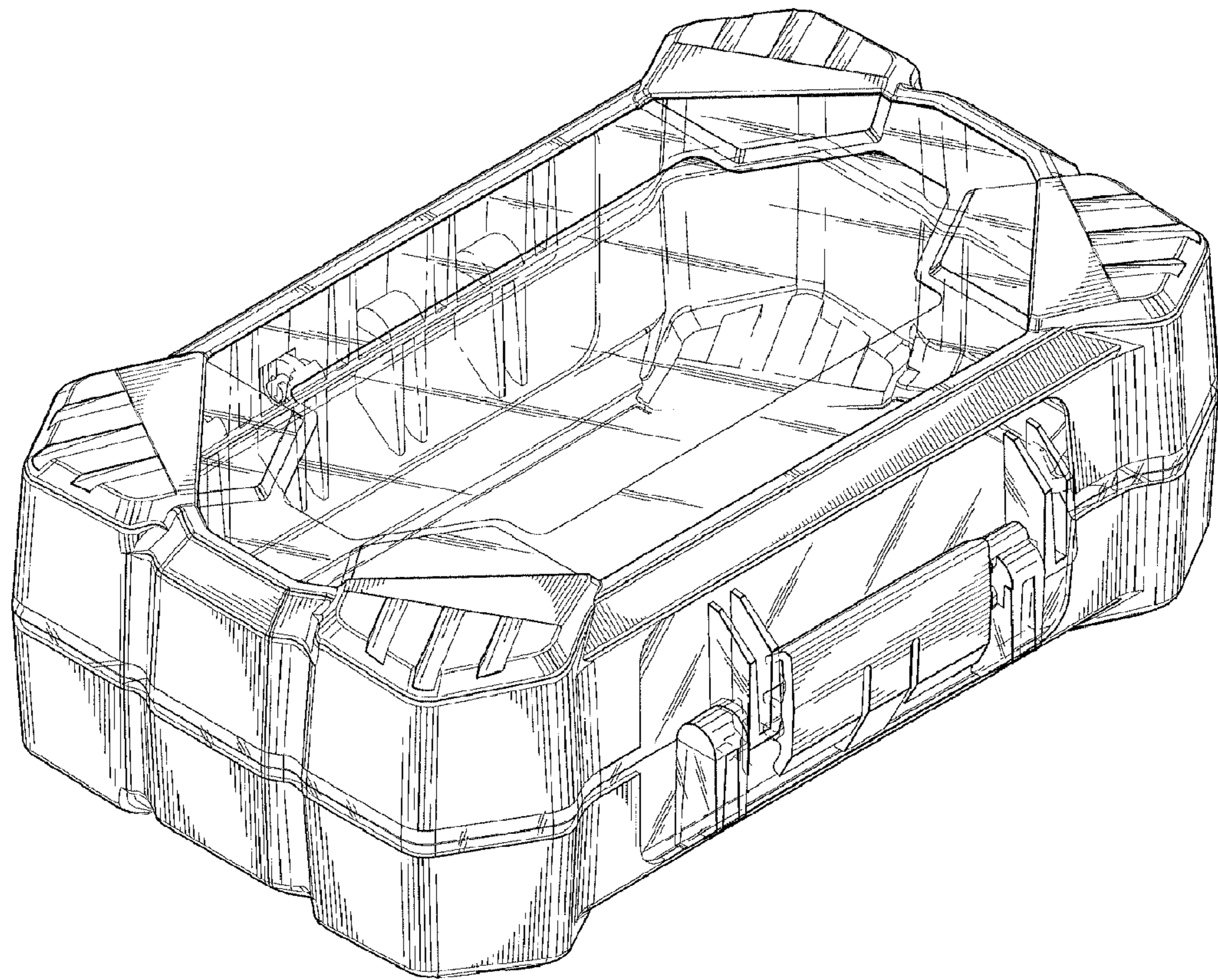

Fig. 1.

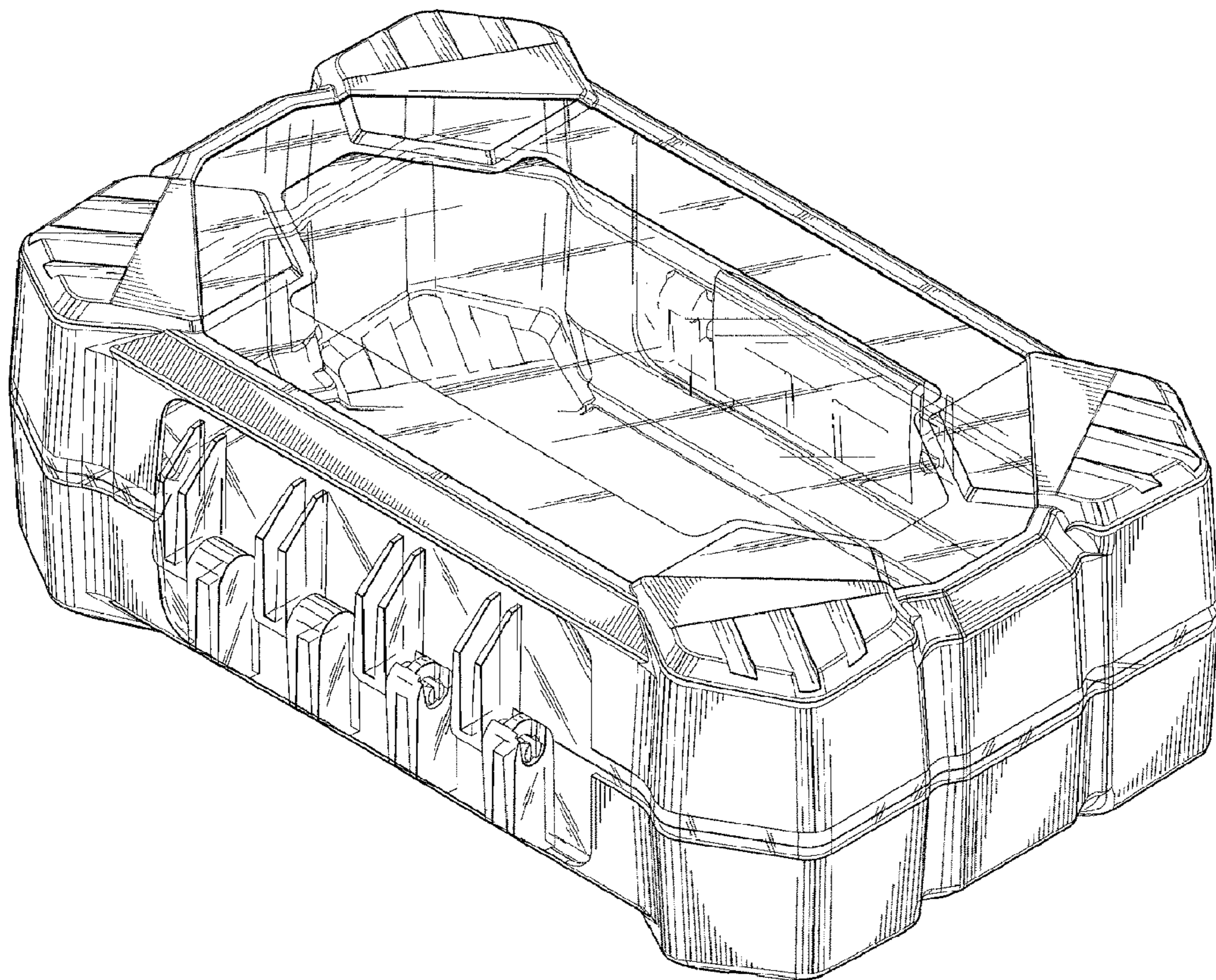

Fig. 2.

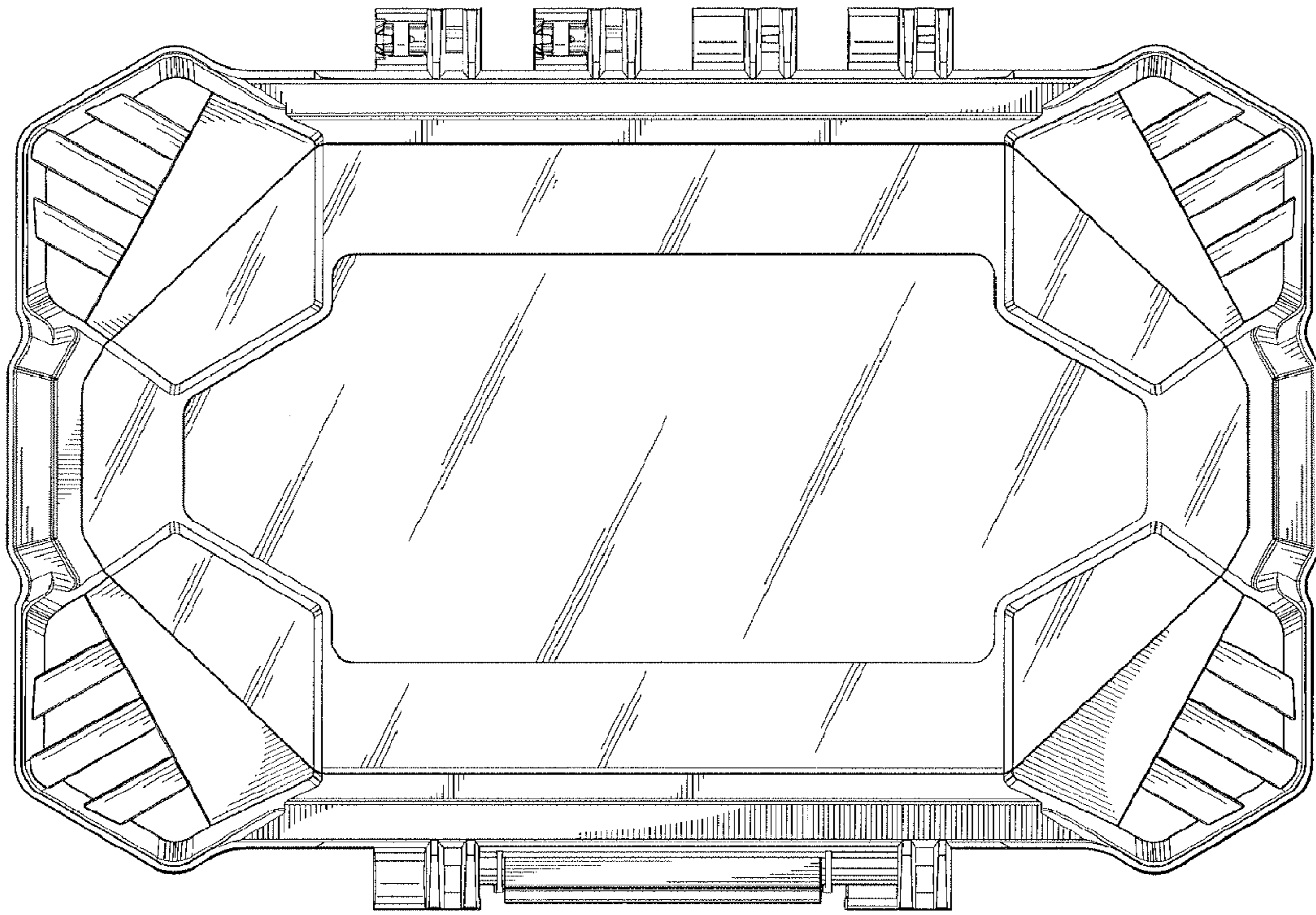

Fig. 3.

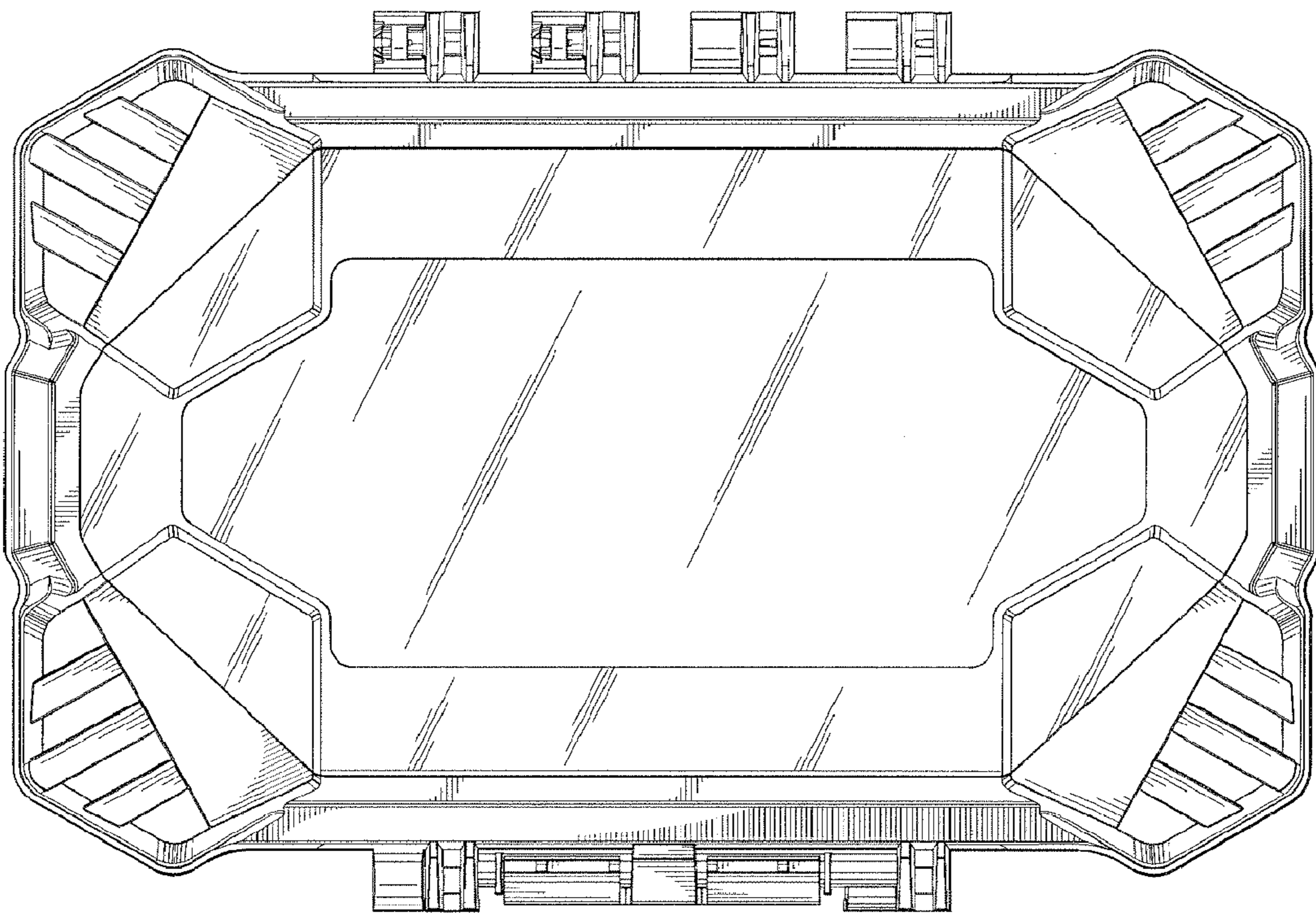

Fig. 4.

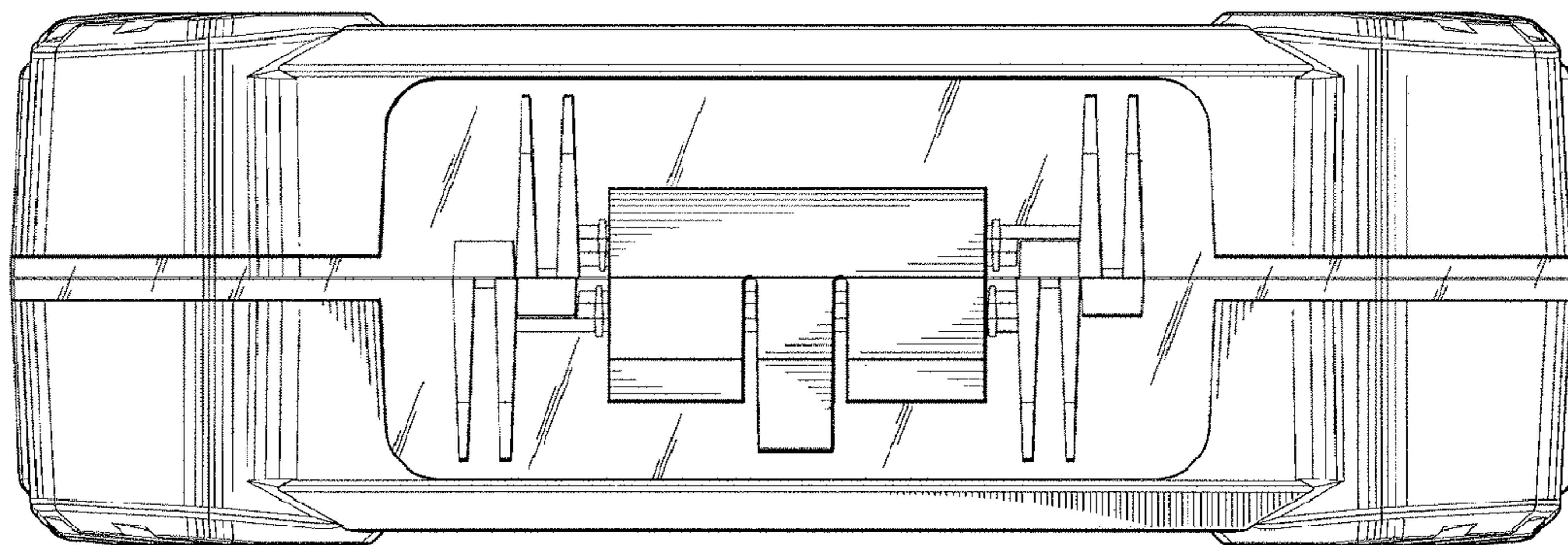

Fig. 5.

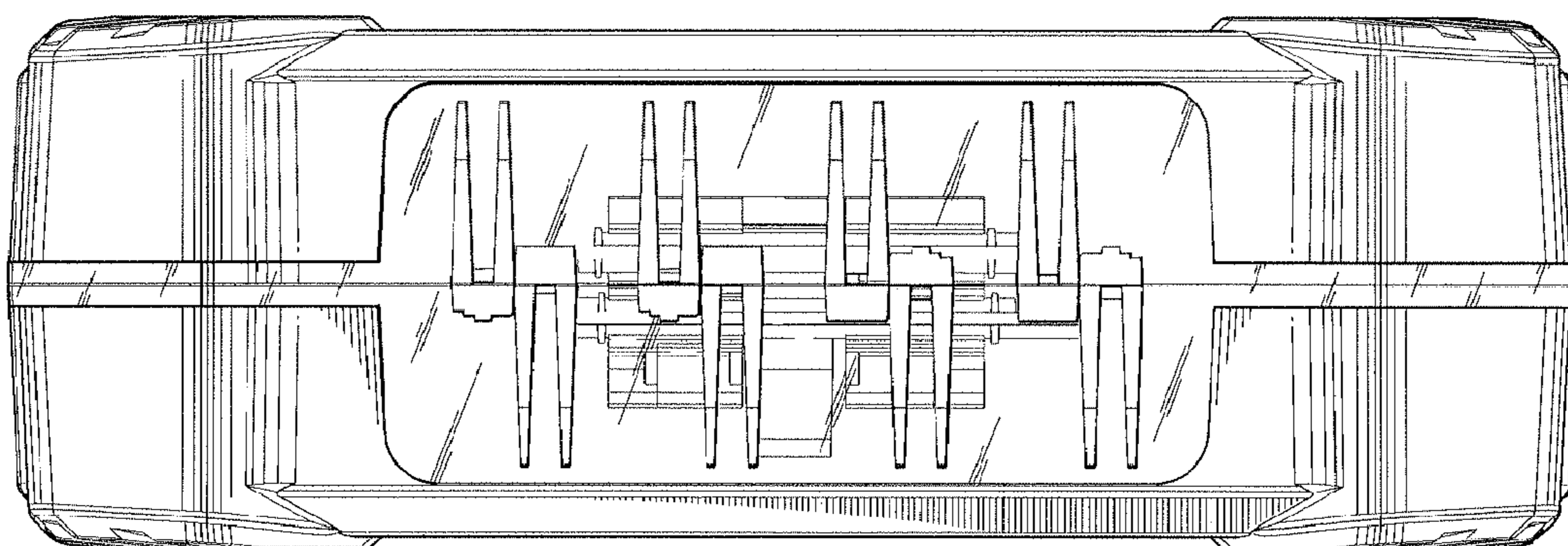

Fig. 6.

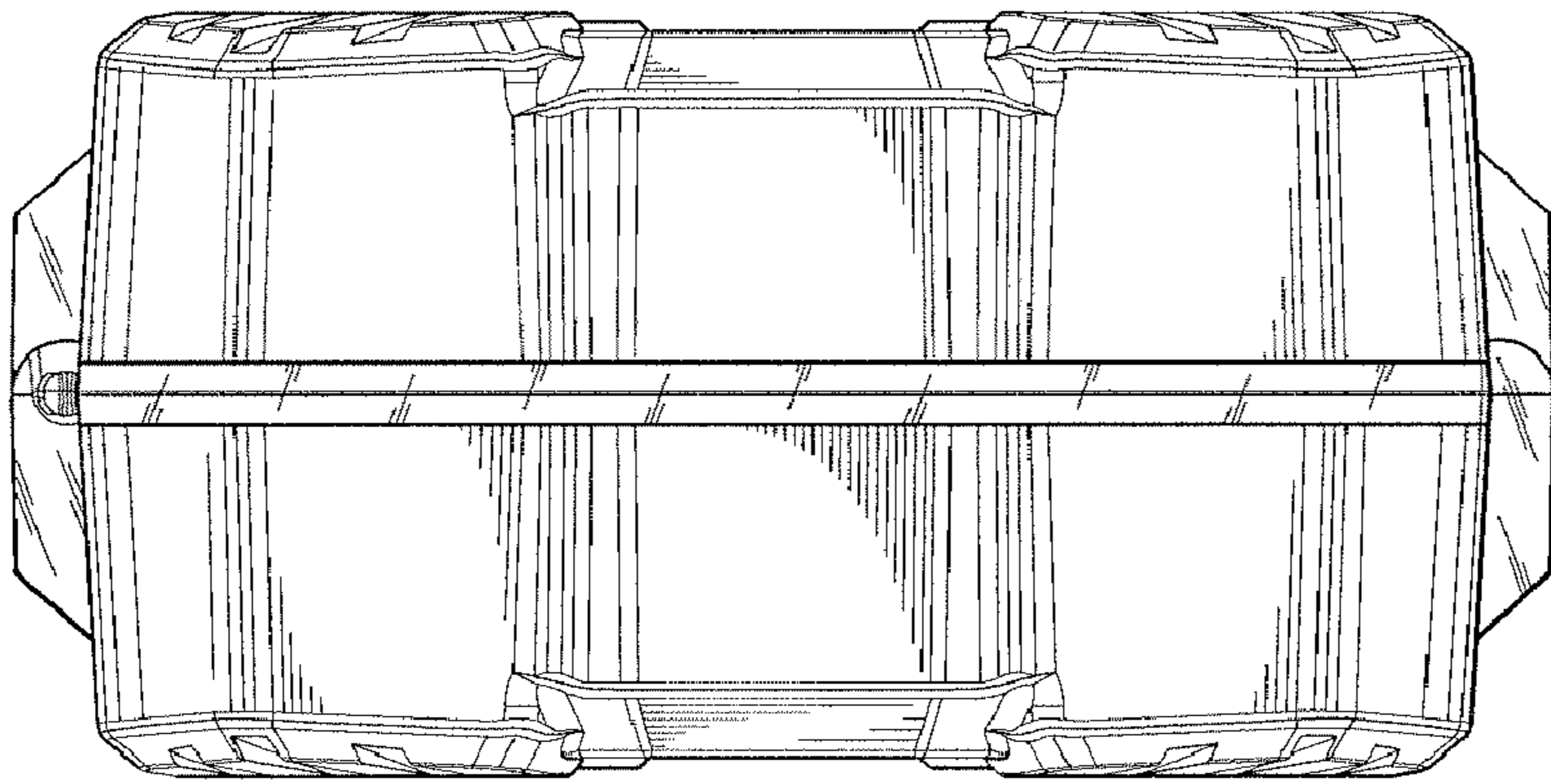

Fig. 7.

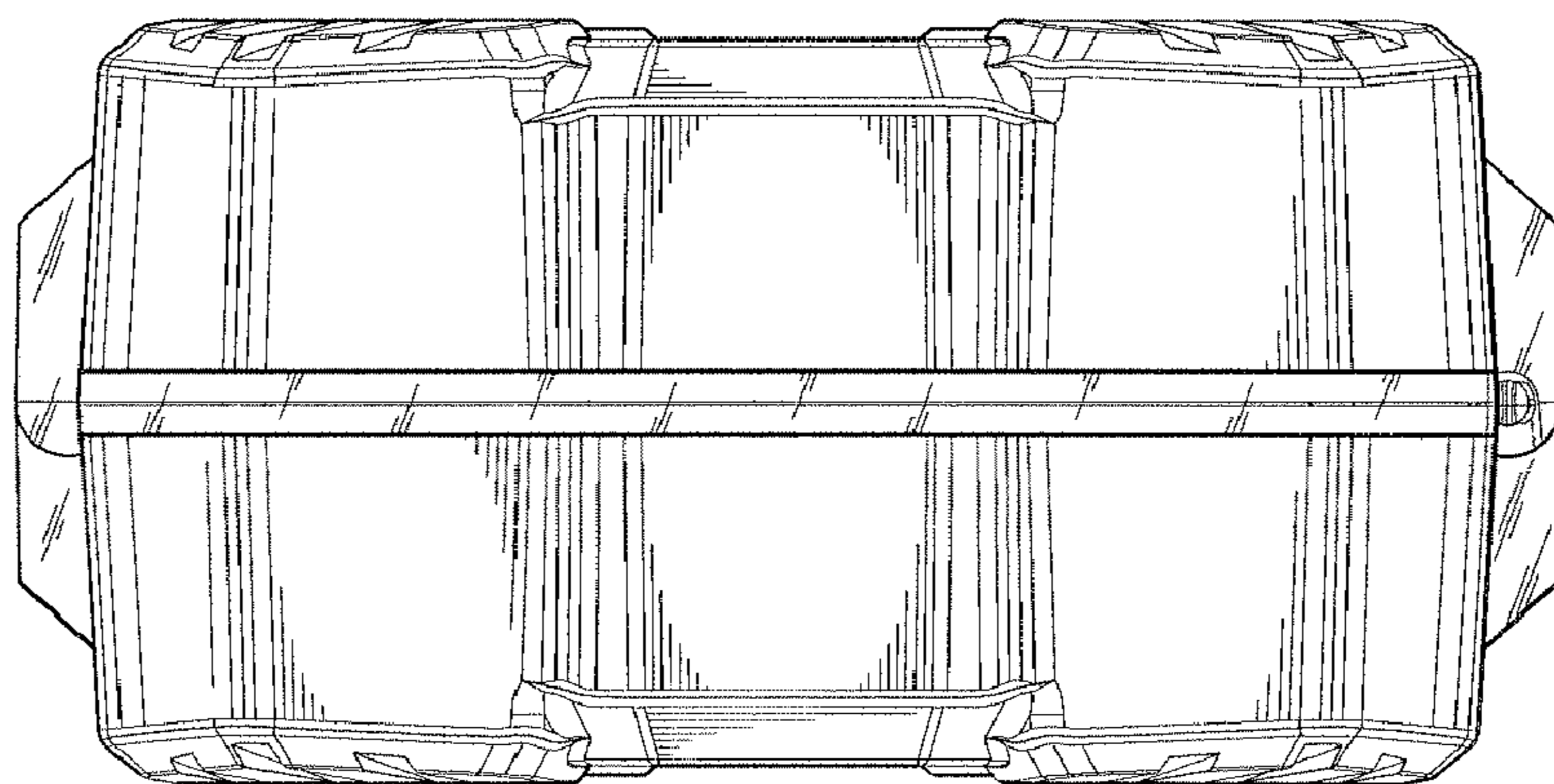

Fig. 8.