



US00D563037S

(12) **United States Design Patent**
Wong

(10) **Patent No.:** **US D563,037 S**

(45) **Date of Patent:** **** Feb. 26, 2008**

(54) **CLIP LIGHTER**

(75) Inventor: **Man Lung Wong**, Tseung Kwan O (HK)

(73) Assignee: **Oneworld Global Manufacturing Solutions Limited**, Kowloon (HK)

(**) Term: **14 Years**

(21) Appl. No.: **29/287,091**

(22) Filed: **Jun. 26, 2007**

(51) **LOC (8) Cl.** **27-05**

(52) **U.S. Cl.** **D27/142; D27/157**

(58) **Field of Classification Search** D27/141-161;
431/253-256, 273-277, 129, 151-153, 143;
D3/215

See application file for complete search history.

(56) **References Cited**

U.S. PATENT DOCUMENTS

D240,139 S *	6/1976	Neyret	D27/156
D313,085 S *	12/1990	Eisenbraun	D27/142
D321,569 S *	11/1991	Wallace	D27/142
D475,481 S *	6/2003	Xu	D27/142
D489,478 S *	5/2004	Shioi	D27/142
D550,897 S *	9/2007	Smith	D27/159

* cited by examiner

Primary Examiner—Jennifer Rivard

(74) *Attorney, Agent, or Firm*—Buchanan Ingersoll & Rooney, PC

(57) **CLAIM**

The ornamental design for a clip lighter, as shown and described.

DESCRIPTION

FIG. 1 is a front view of a clip lighter showing my new design;

FIG. 2 is a rear view thereof;

FIG. 3 is a left side view thereof;

FIG. 4 is a right side view thereof;

FIG. 5 is a top view thereof;

FIG. 6 is a bottom view thereof;

FIG. 7 is a left front perspective view thereof;

FIG. 8 is a right front perspective view thereof;

FIG. 9 is a left rear perspective view thereof;

FIG. 10 is a right rear perspective view thereof;

FIG. 11 is a front view of the clip lighter in an alternate configuration;

FIG. 12 is a rear view thereof;

FIG. 13 is a left side view thereof;

FIG. 14 is a right side view thereof;

FIG. 15 is a top view thereof;

FIG. 16 is a bottom view thereof;

FIG. 17 is a left rear perspective view thereof;

FIG. 18 is a left front perspective view thereof;

FIG. 19 is a right rear perspective view thereof; and,

FIG. 20 is a right front perspective view thereof.

1 Claim, 8 Drawing Sheets

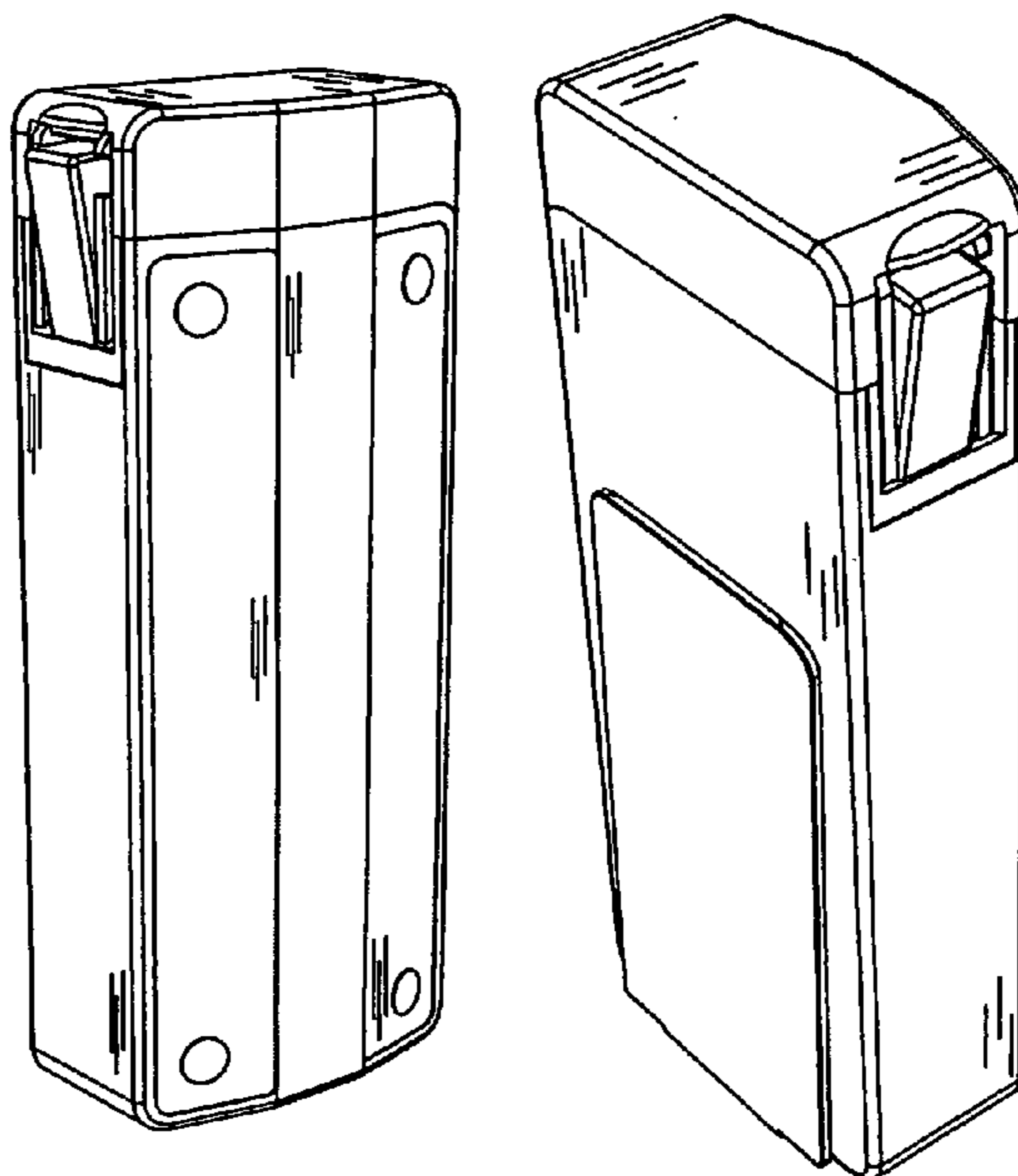

FIG. 1

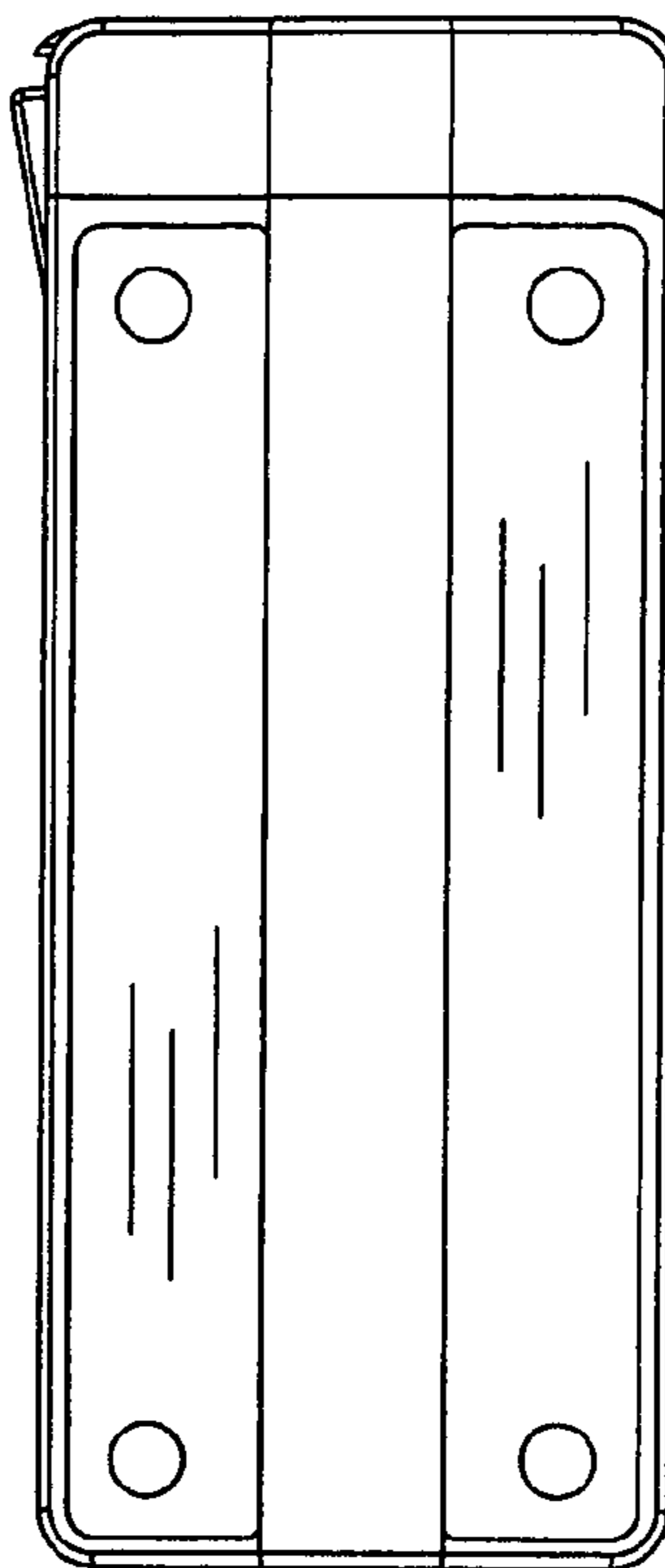

FIG. 2

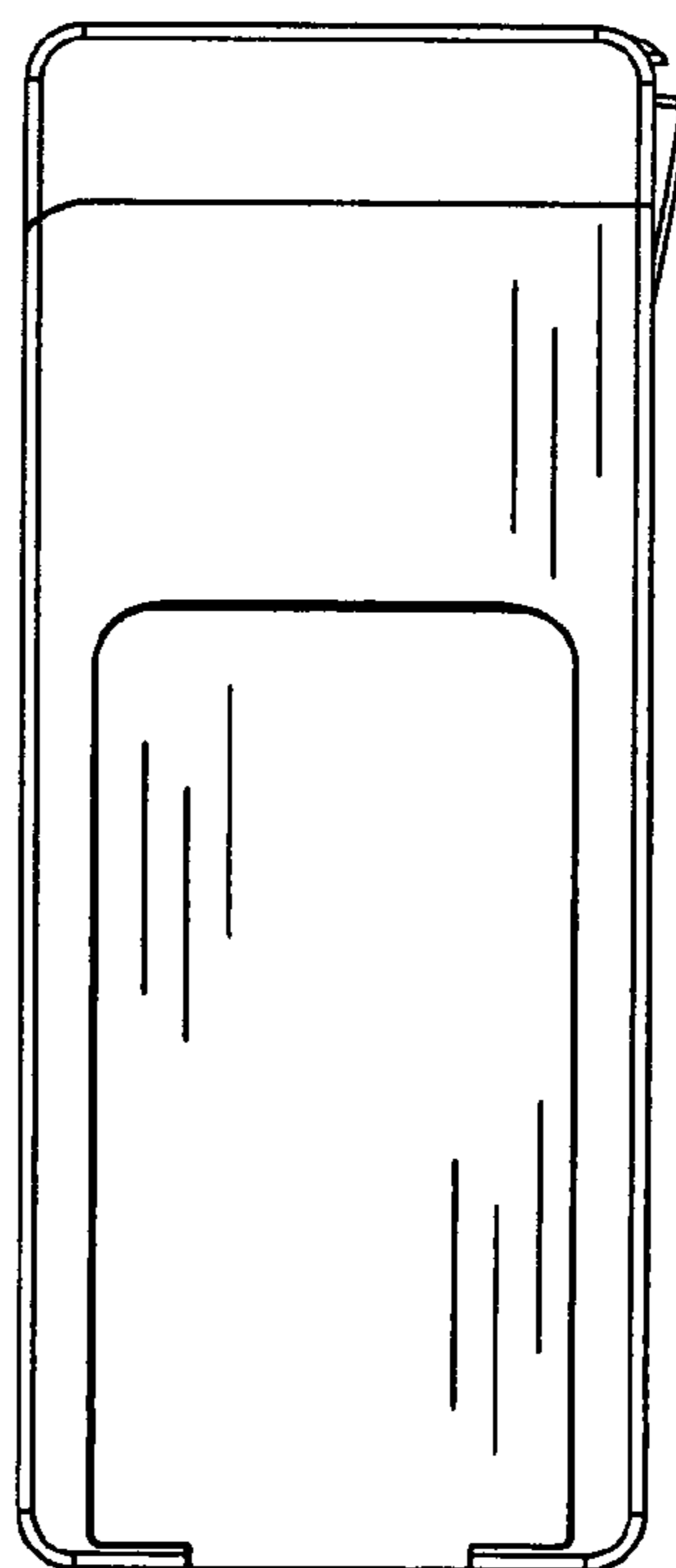

FIG. 3

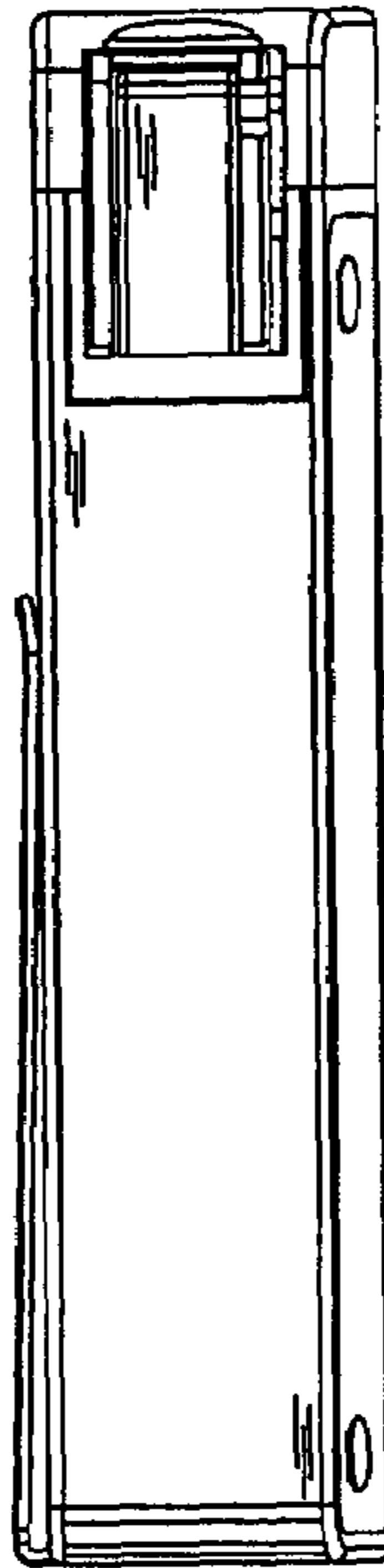

FIG. 4

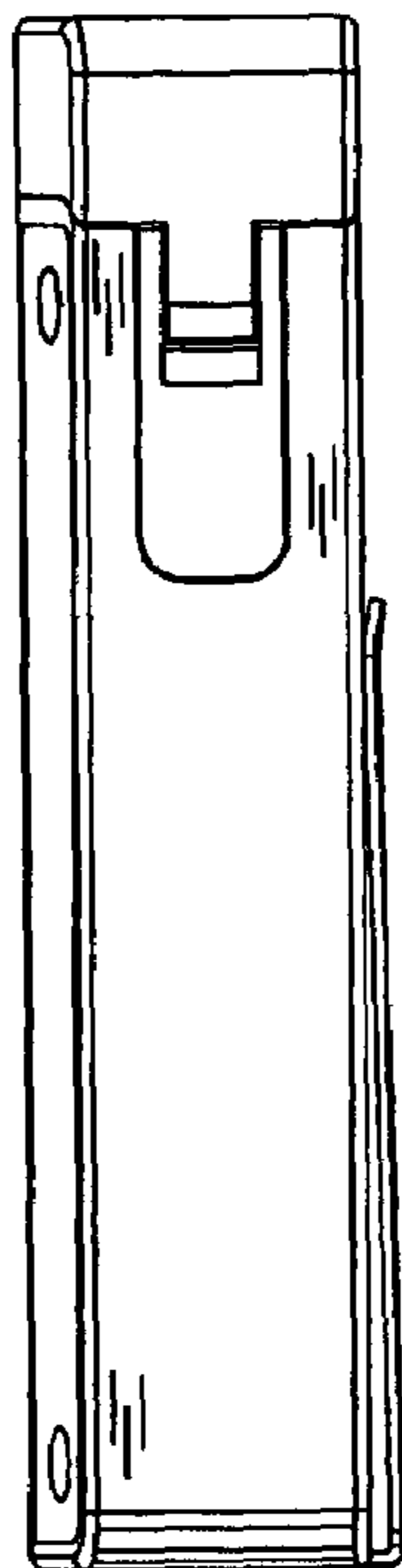

FIG. 5

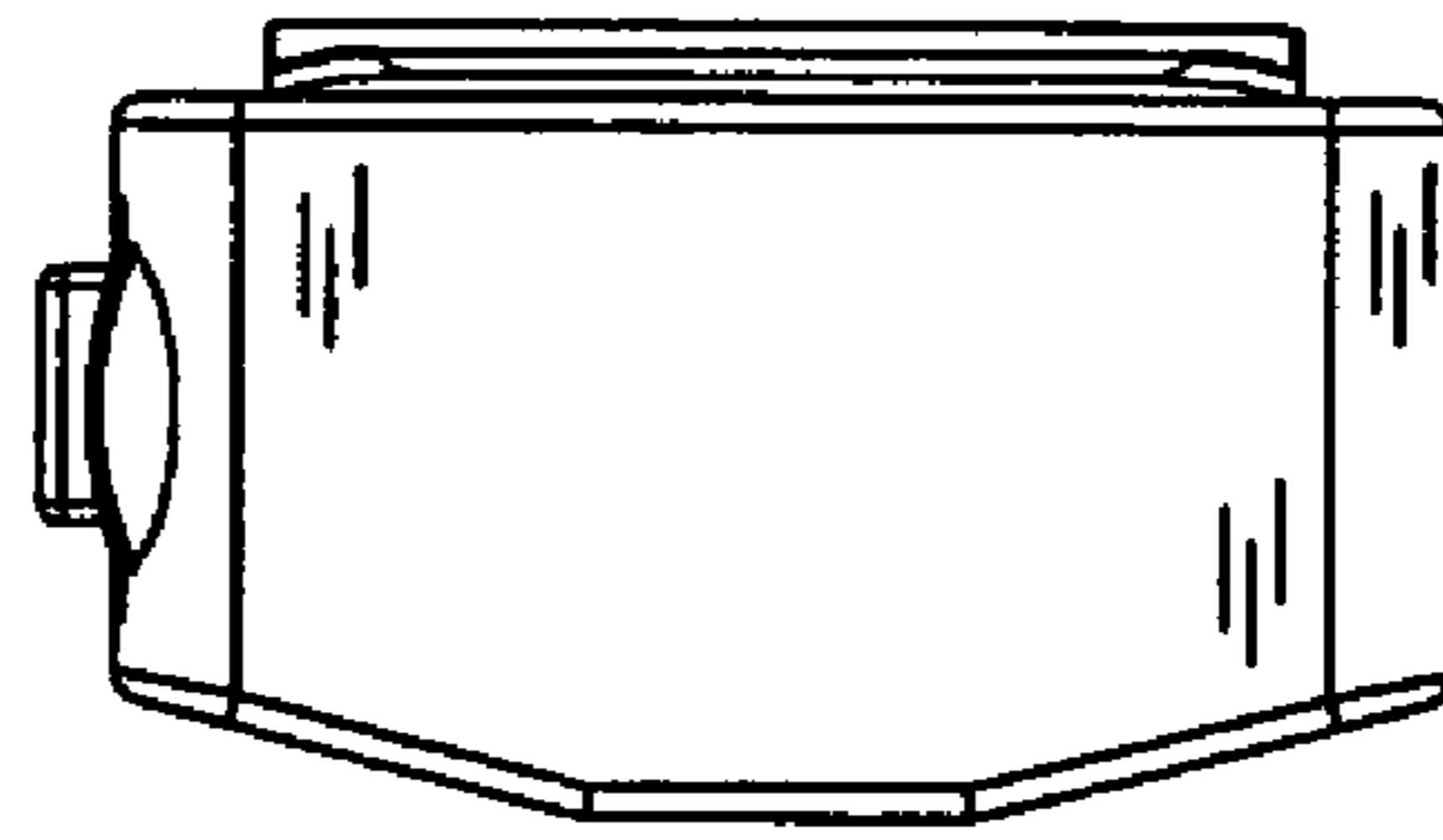

FIG. 6

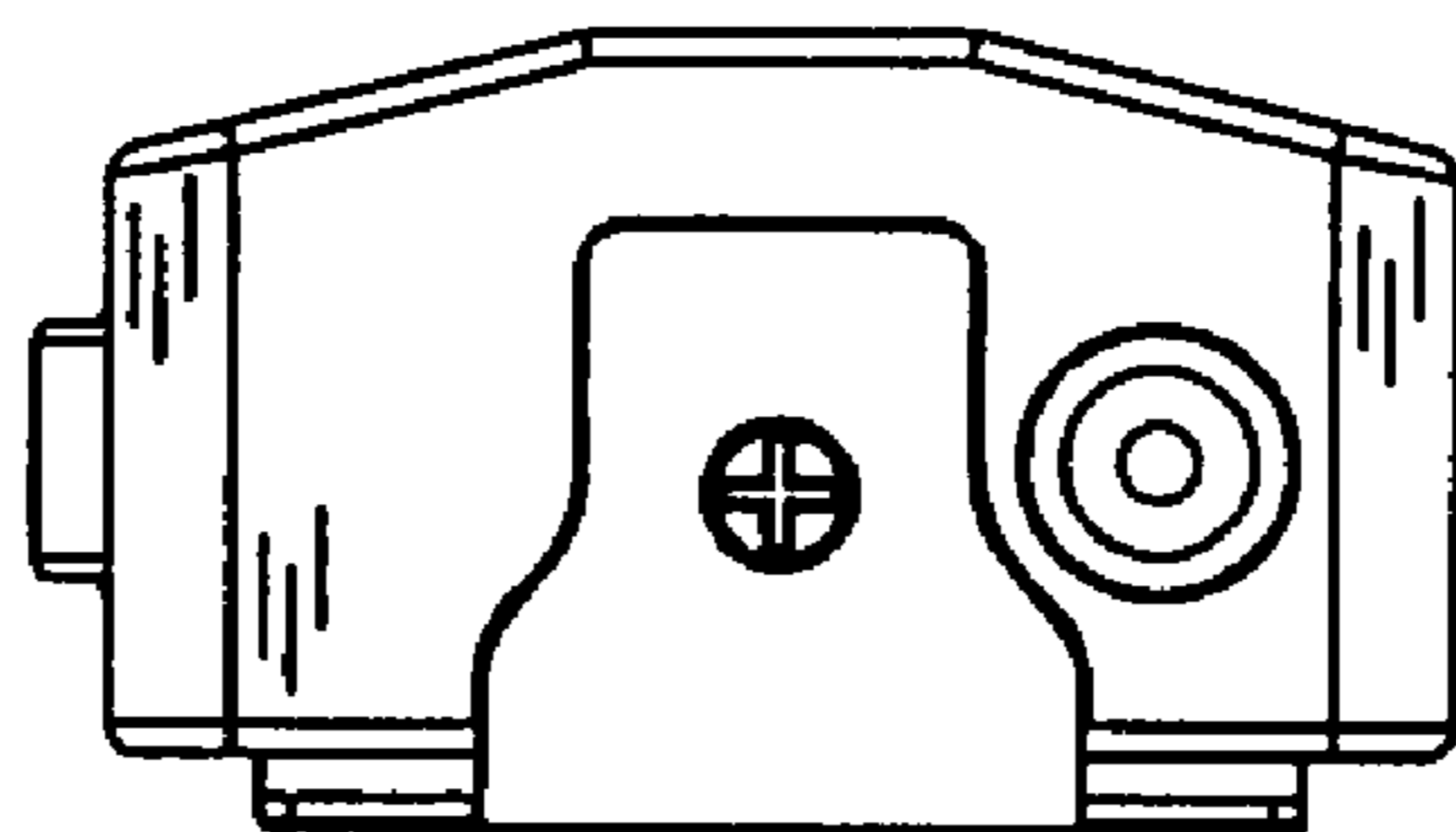

FIG. 7

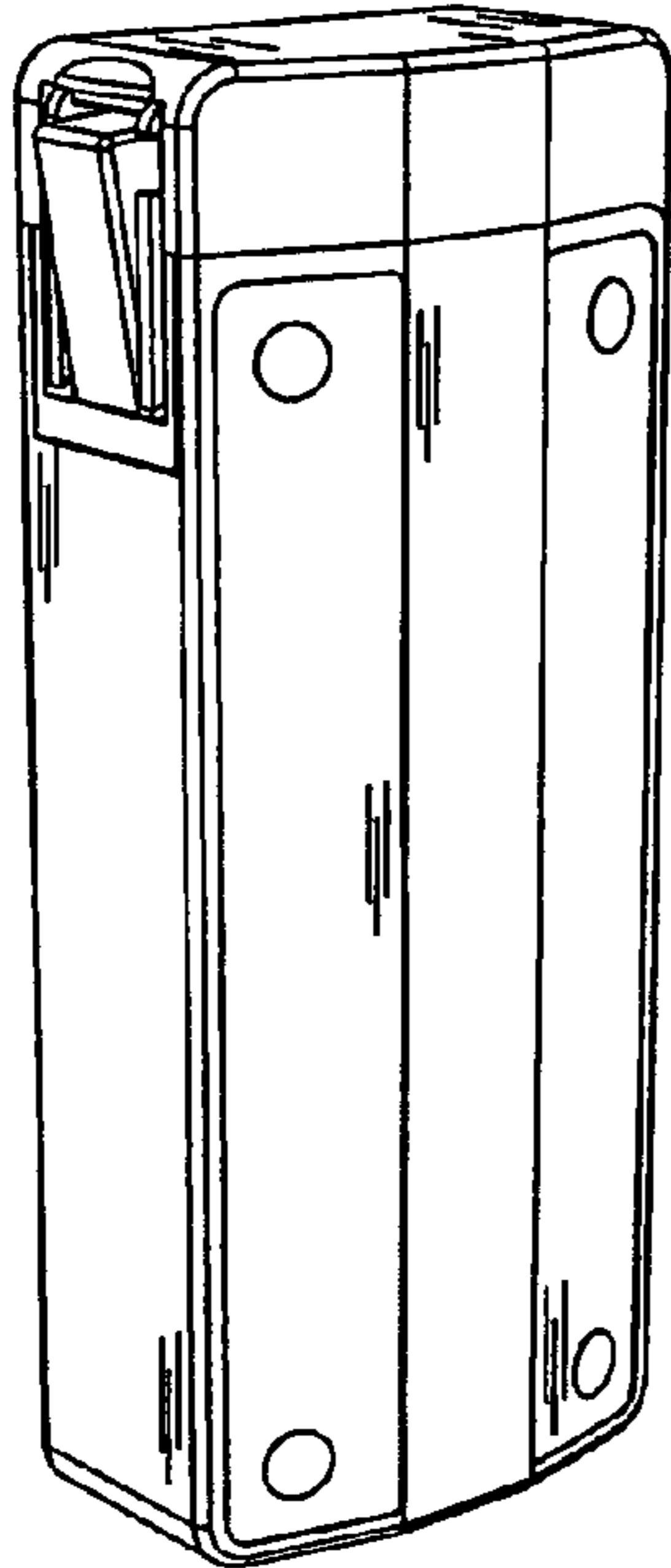

FIG. 8

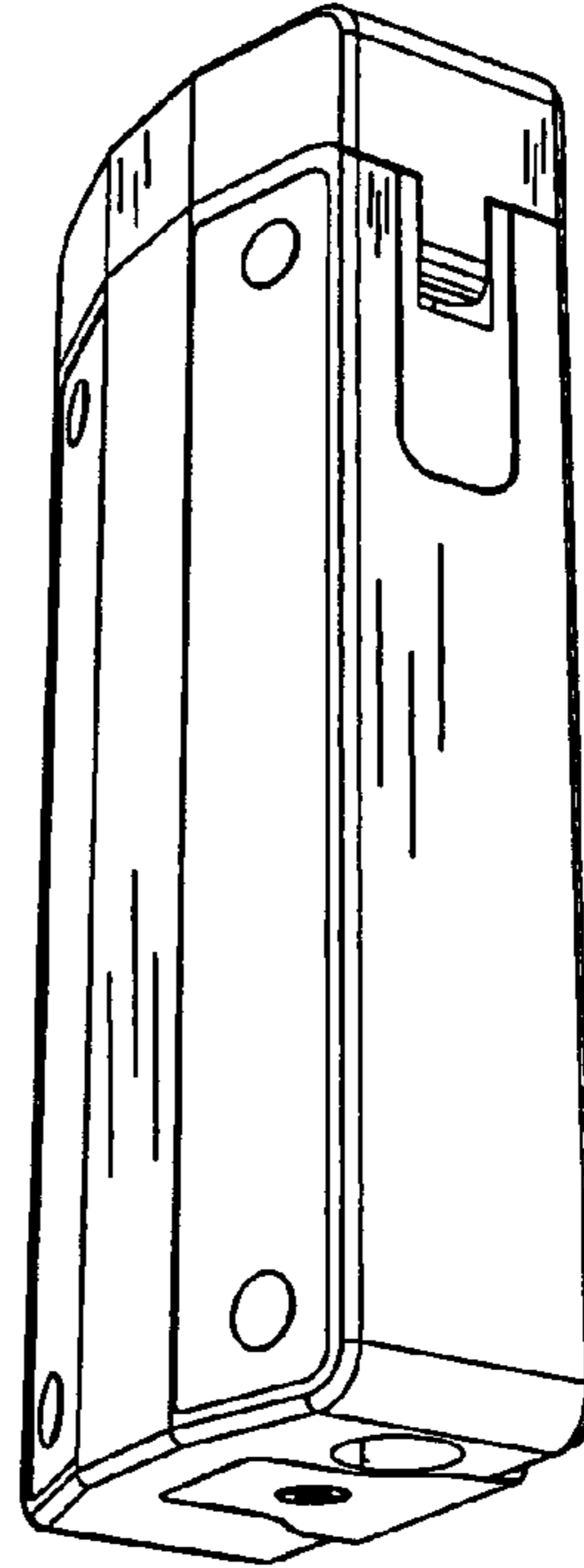

FIG. 9

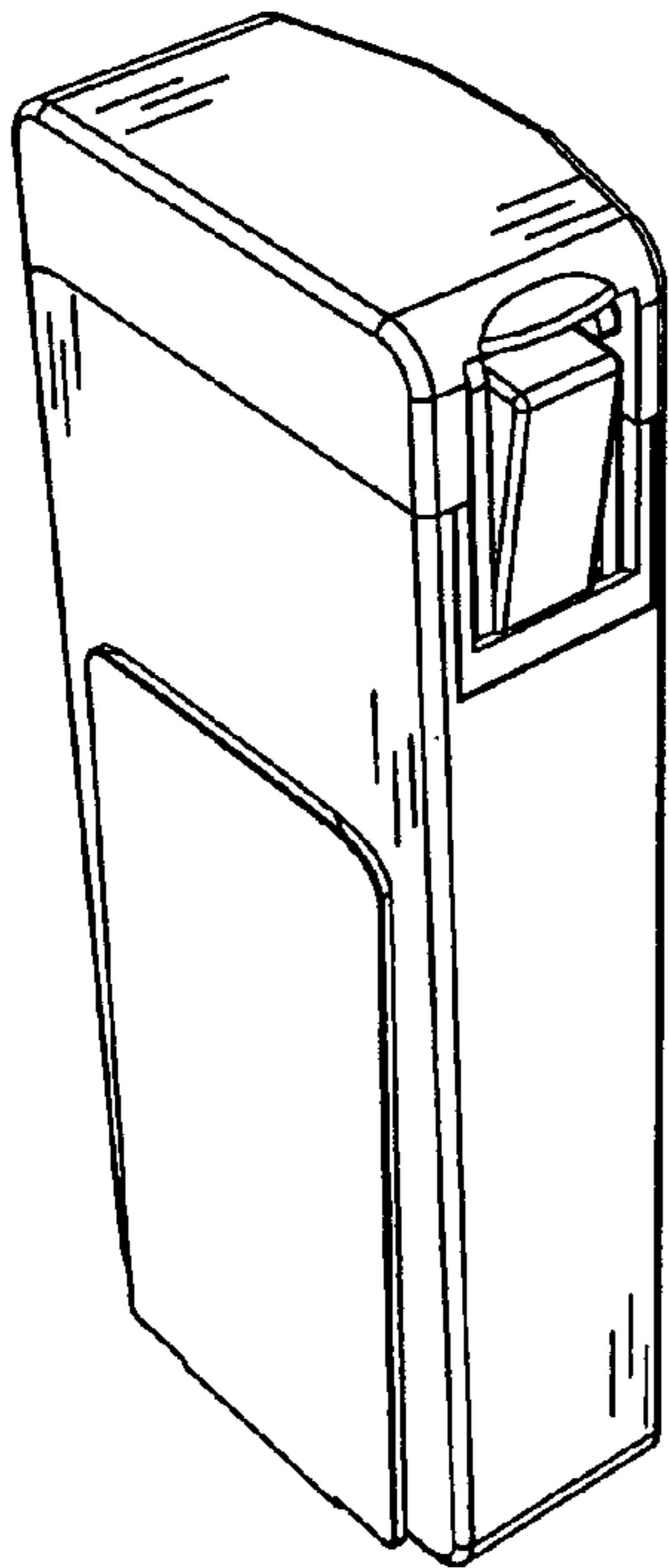

FIG. 10

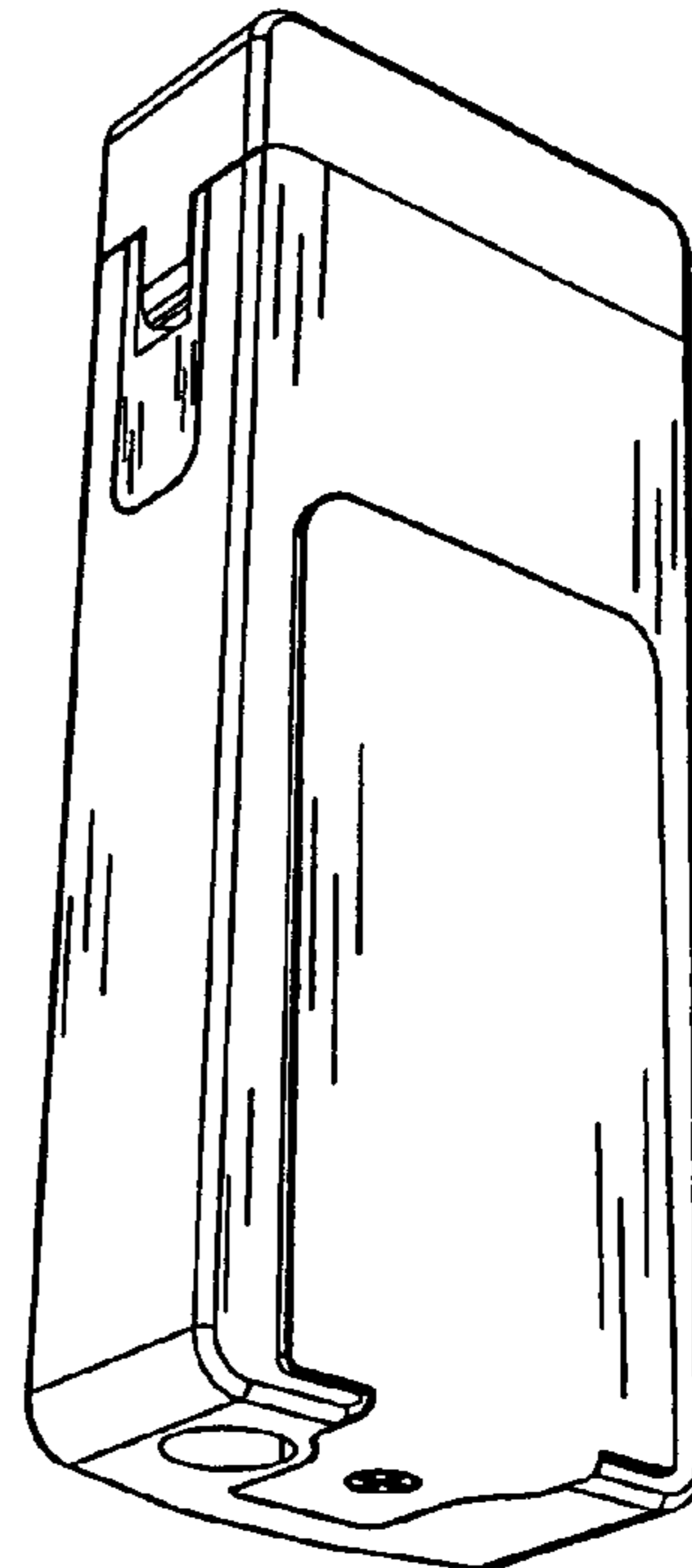

FIG. 11

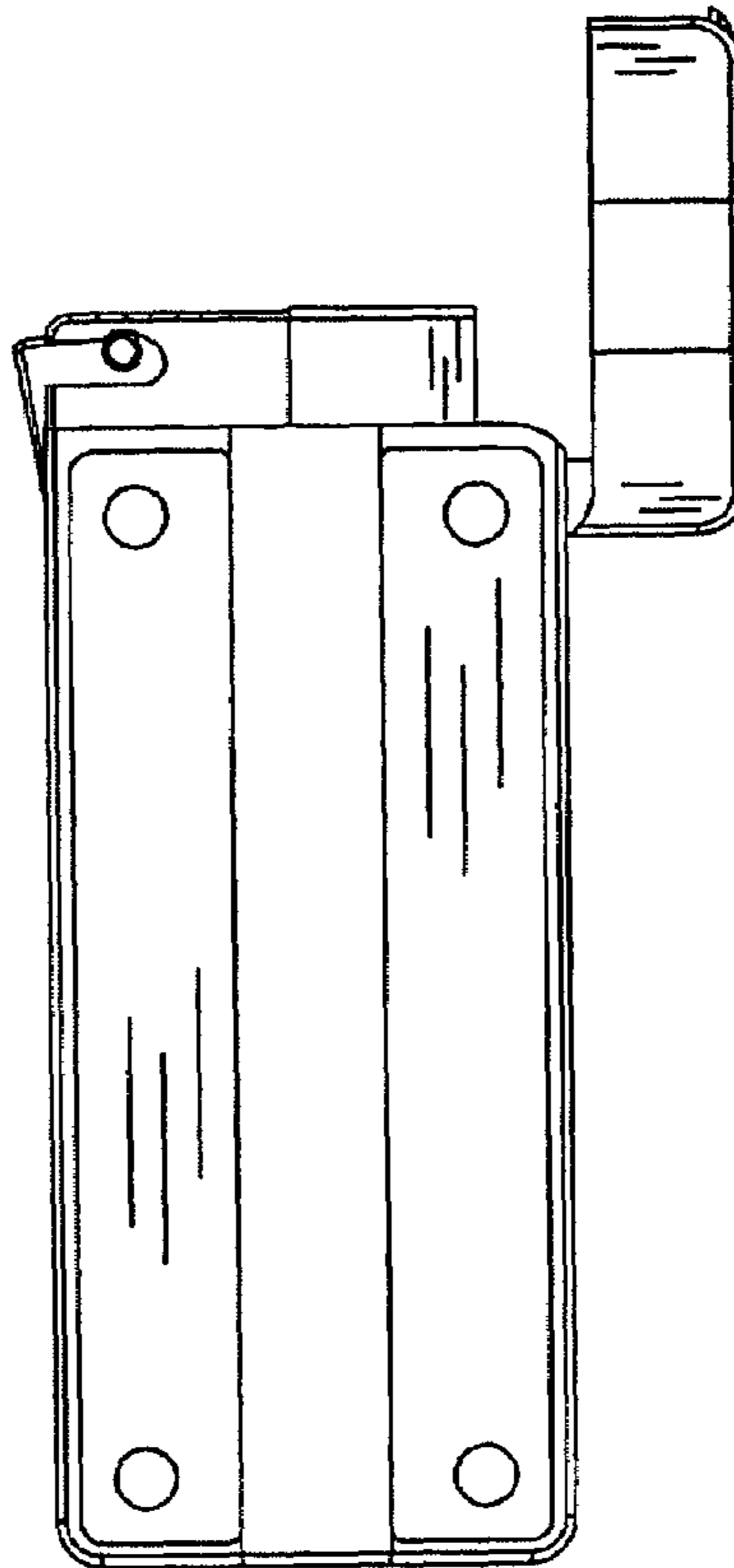

FIG. 12

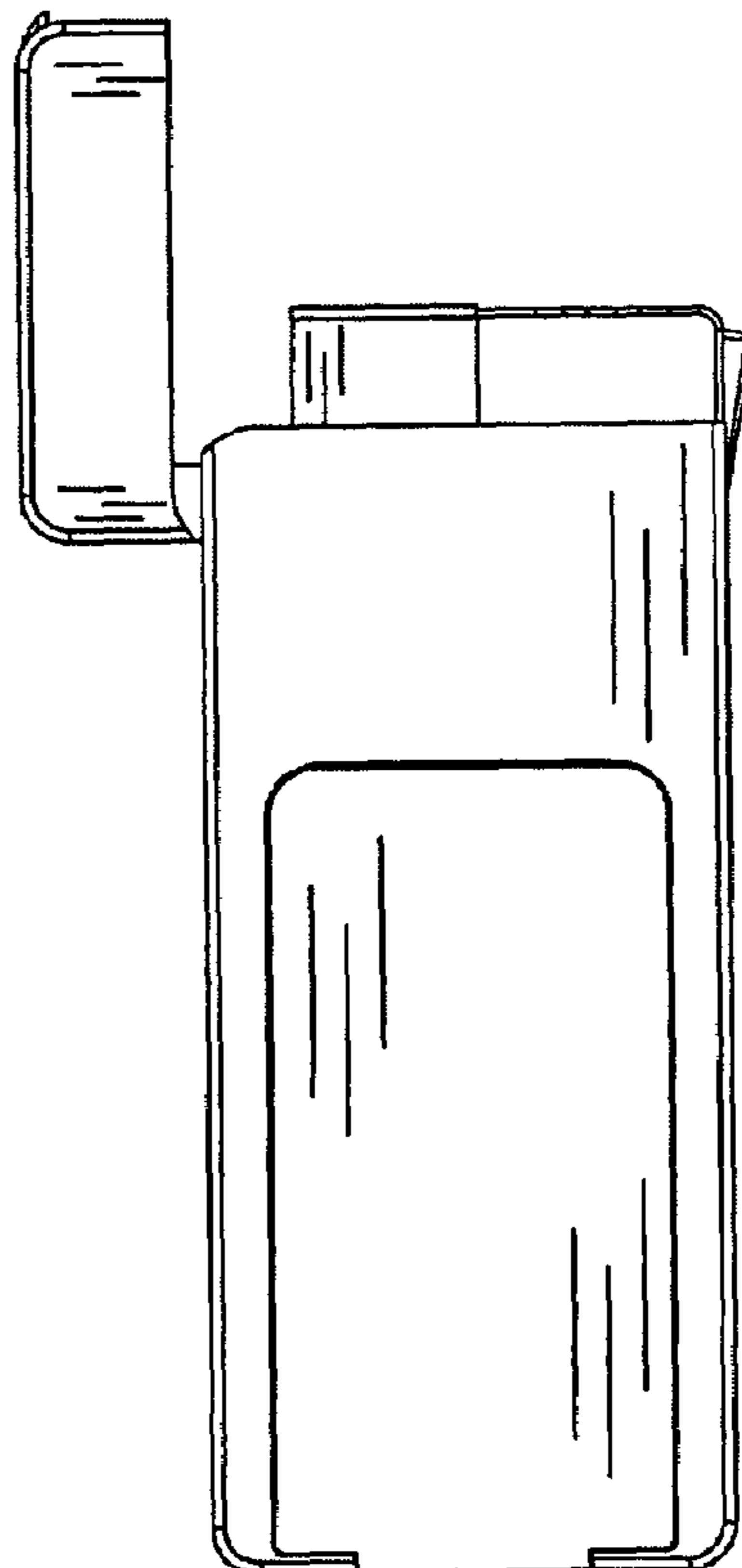

FIG. 13

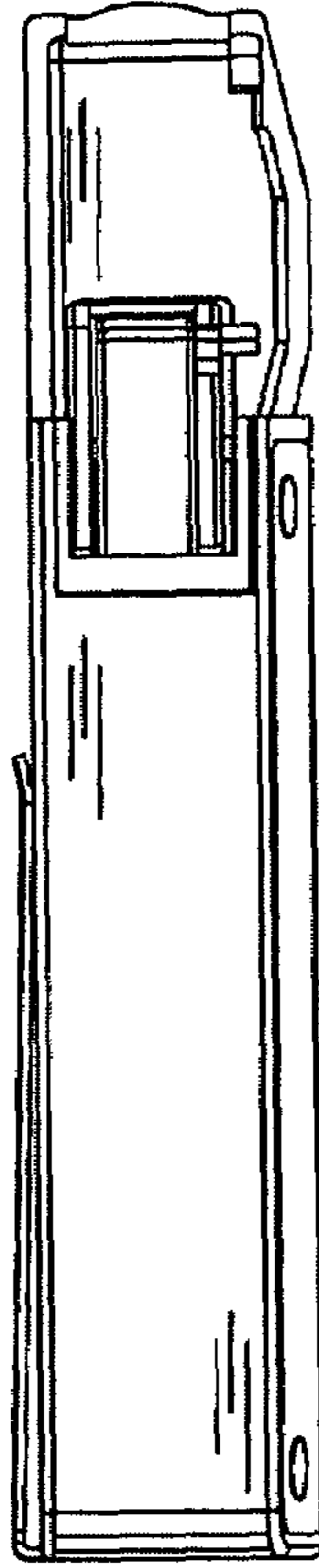

FIG. 14

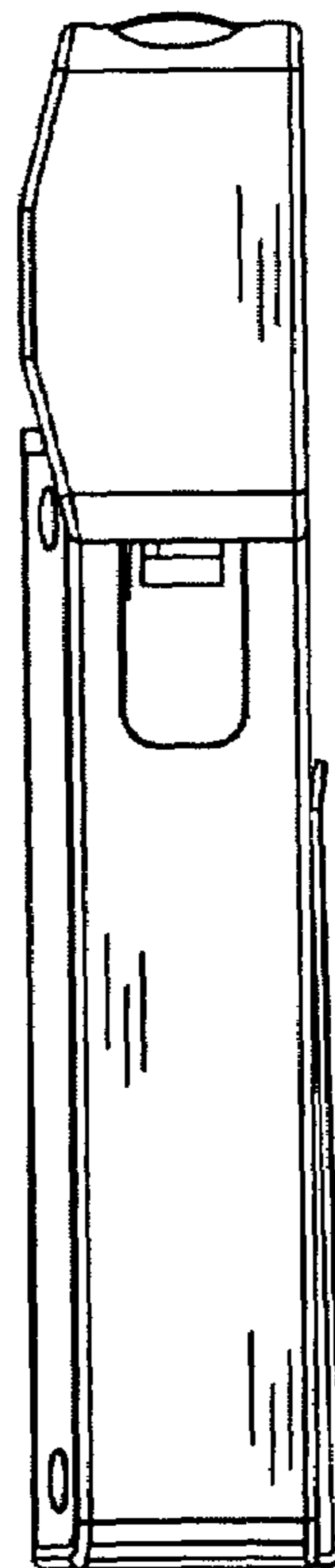

FIG. 15

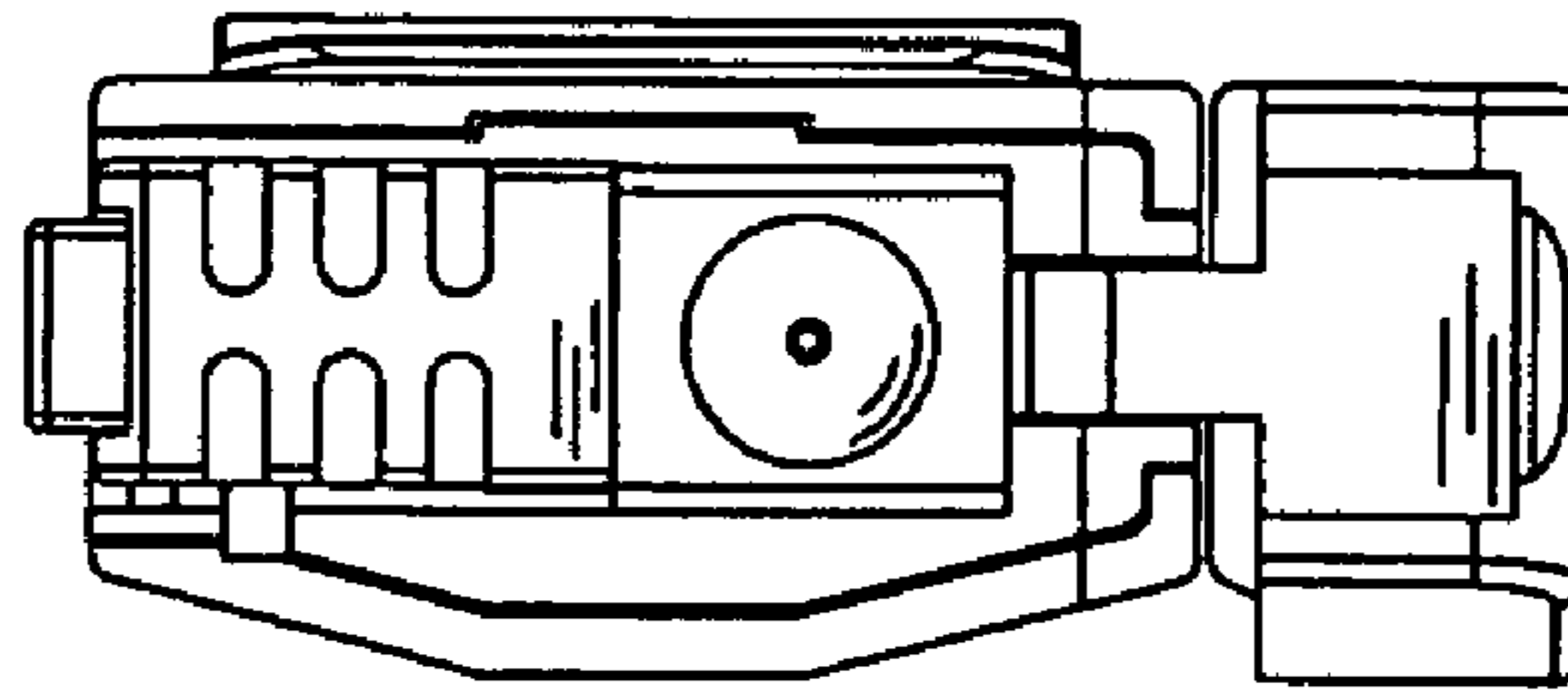

FIG. 16

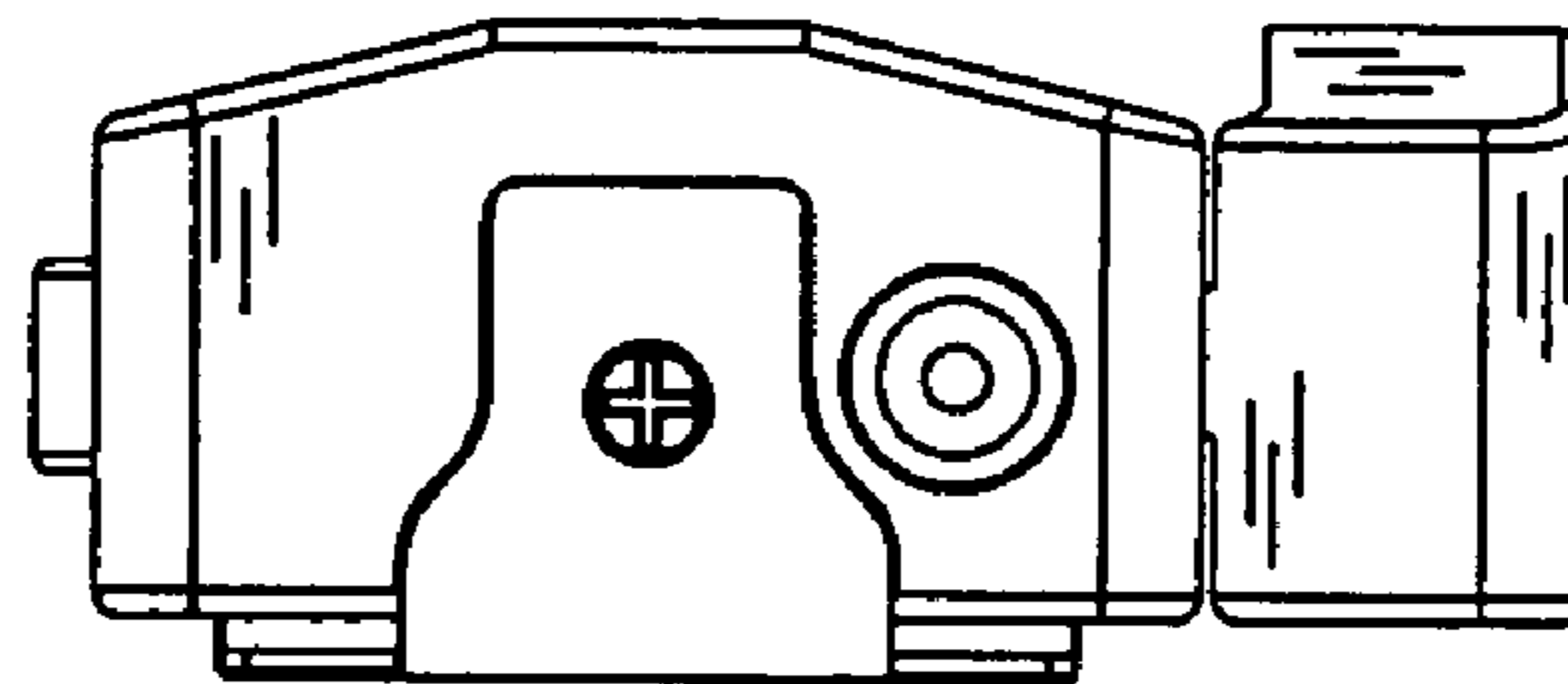

FIG. 17

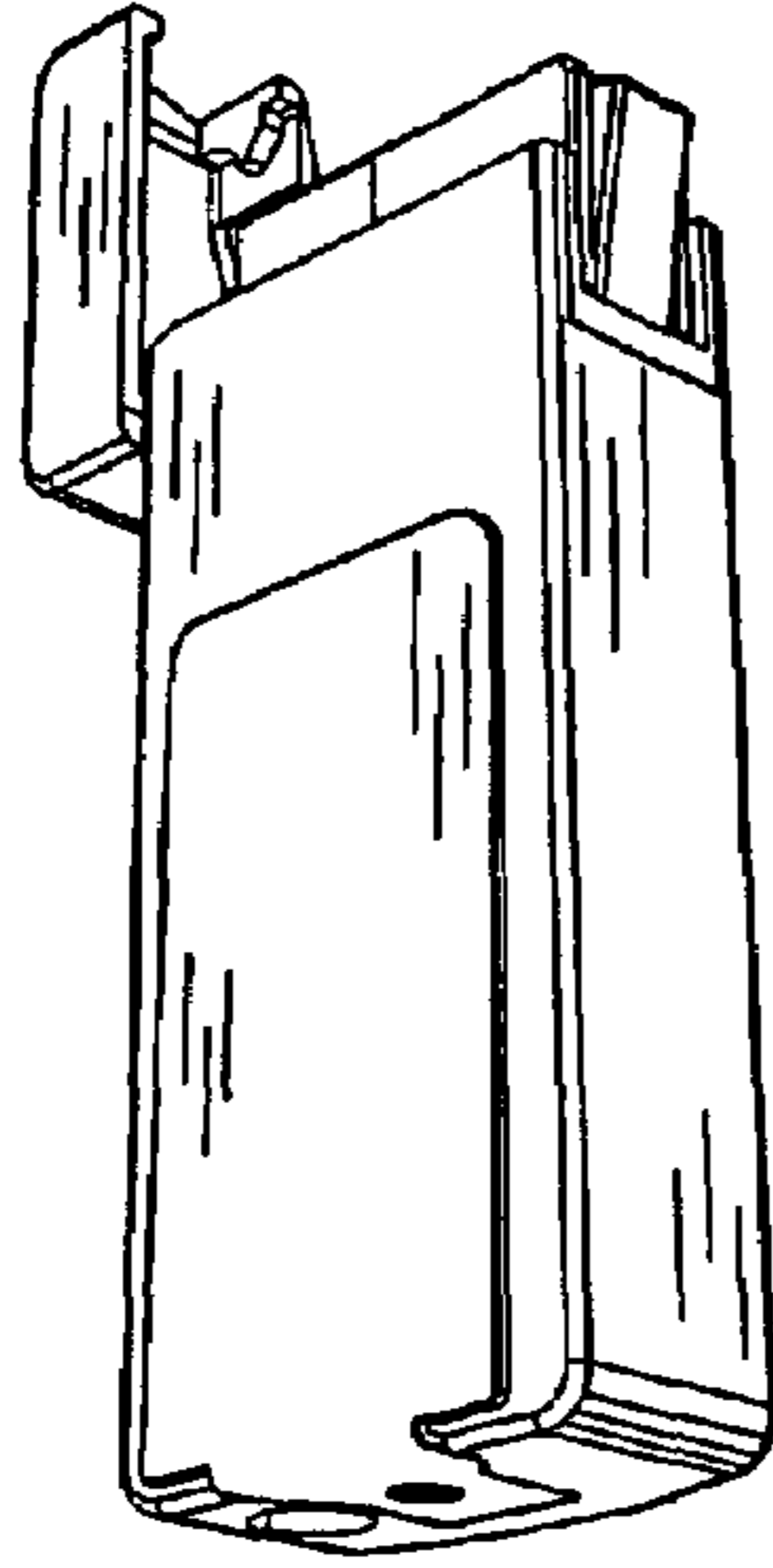

FIG. 18

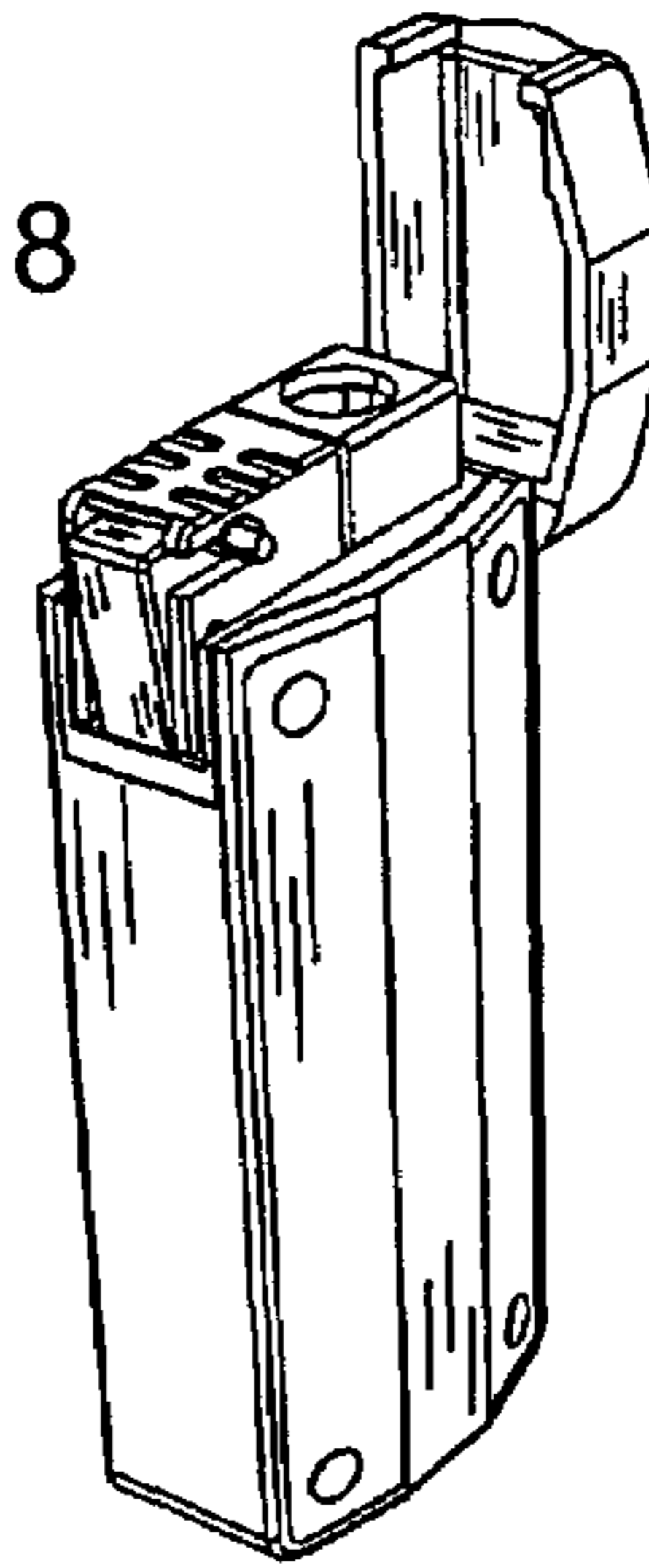

FIG. 19

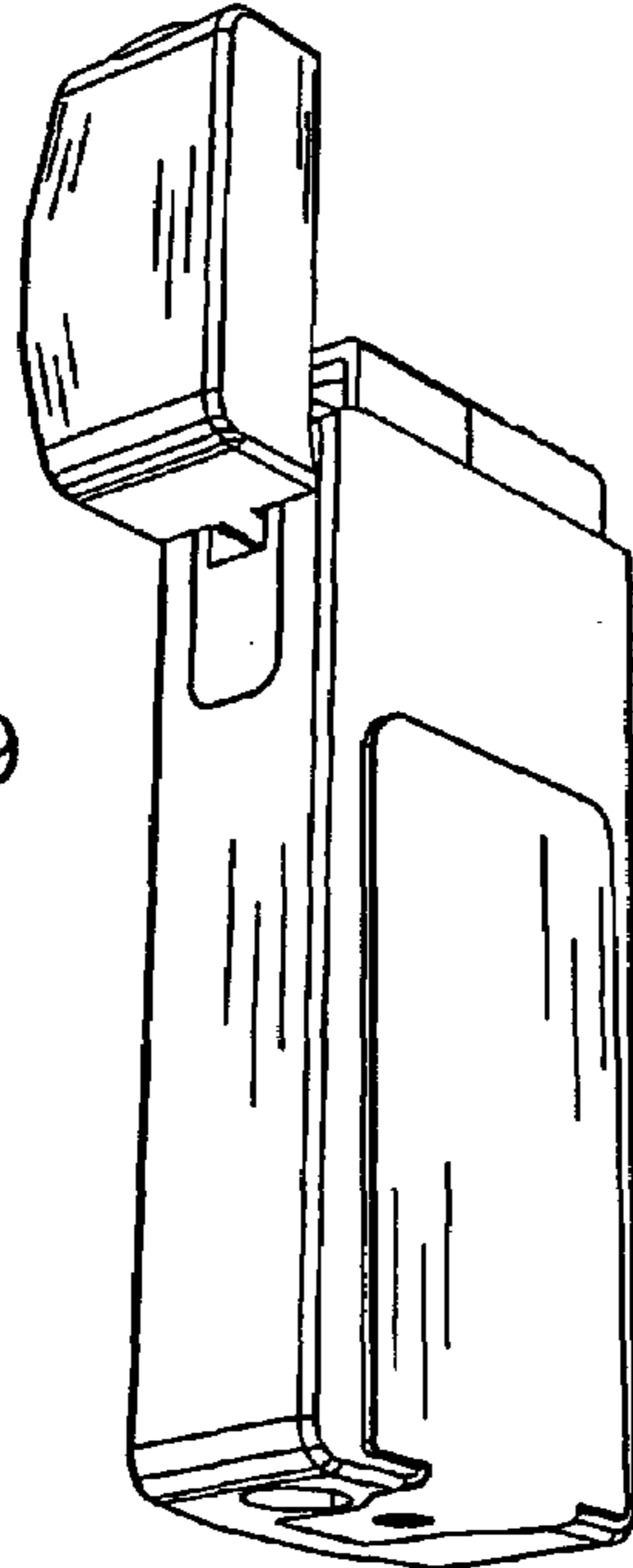

FIG. 20

