



US00D562856S

(12) **United States Design Patent** (10) **Patent No.:** **US D562,856 S**
Hawley et al. (45) **Date of Patent:** **** Feb. 26, 2008**

(54) **PLASMA GUN ANODE**

2004/0237530 A1* 12/2004 Brown 60/740
2006/0016789 A1* 1/2006 MacKenzie et al. 219/121.5
2006/0289404 A1* 12/2006 Hawley et al. 219/121.47

(76) Inventors: **Dave Hawley**, 1101 Prospect Ave.,
Westbury, NY (US) 11590; **Richard
McCullough**, 1101 Prospect Ave.,
Westbury, NY (US) 11590

FOREIGN PATENT DOCUMENTS

EP 0645946 B1 12/1996
EP 1065914 B1 1/2004

(**) Term: **14 Years**

OTHER PUBLICATIONS

(21) Appl. No.: **29/265,819**

Sulzer Metco Praxair and Wokajet Brochure, dated 2005.

(22) Filed: **Sep. 8, 2006**

* cited by examiner

Related U.S. Application Data

Primary Examiner—Antoine D. Davis
Assistant Examiner—Patricia Palasik
(74) *Attorney, Agent, or Firm*—Hogan & Hartson L.L.P.

(63) Continuation of application No. 11/392,650, filed on
Mar. 30, 2006.

(57) **CLAIM**

(51) **LOC (8) Cl.** **15-09**

The ornamental design for a plasma gun anode, as shown
and described.

(52) **U.S. Cl.** **D15/144**

(58) **Field of Classification Search** D15/144–144.2;
219/76, 121.47, 121.48, 121.51

See application file for complete search history.

DESCRIPTION

(56) **References Cited**

U.S. PATENT DOCUMENTS

4,455,470 A 6/1984 Klein et al.
D284,264 S * 6/1986 Resan D8/382
4,688,722 A 8/1987 Dellassio et al.
4,780,591 A 10/1988 Bernecki et al.
4,788,408 A 11/1988 Wlodarczyk et al.
4,853,515 A 8/1989 Willen et al.
5,013,883 A 5/1991 Fuimefreddo et al.
5,225,652 A 7/1993 Landes
5,332,885 A 7/1994 Landes
5,406,046 A 4/1995 Landes
5,637,242 A 6/1997 Muehlberger
5,744,777 A * 4/1998 Bernecki et al. 219/121.47
5,856,647 A * 1/1999 Luo 219/121.5
D520,037 S * 5/2006 Furujo et al. D15/144
D524,336 S * 7/2006 Conway et al. D15/144
7,126,080 B1 * 10/2006 Renault et al. 219/121.48
7,161,111 B2 * 1/2007 Schneider 219/121.4

FIG. 1 is a perspective view of a first embodiment thereof;
FIG. 2 is a front view of the first embodiment thereof;
FIG. 3 is a rear view the first embodiment thereof;
FIG. 4 is a side view the first embodiment thereof;
FIG. 5 is a perspective view of the first embodiment thereof,
showing for illustrative purposes only, the anode of FIG. 1
mounted in the nozzle assembly of a plasma gun;
FIG. 6 is a perspective view of a second embodiment
thereof;
FIG. 7 is a side view of the second embodiment thereof;
FIG. 8 is a perspective view of a third embodiment thereof;
and,
FIG. 9 is a side view of the third embodiment thereof.

Broken lines shown in the figures are for illustrative pur-
poses only and form no part of the claimed design.

1 Claim, 3 Drawing Sheets

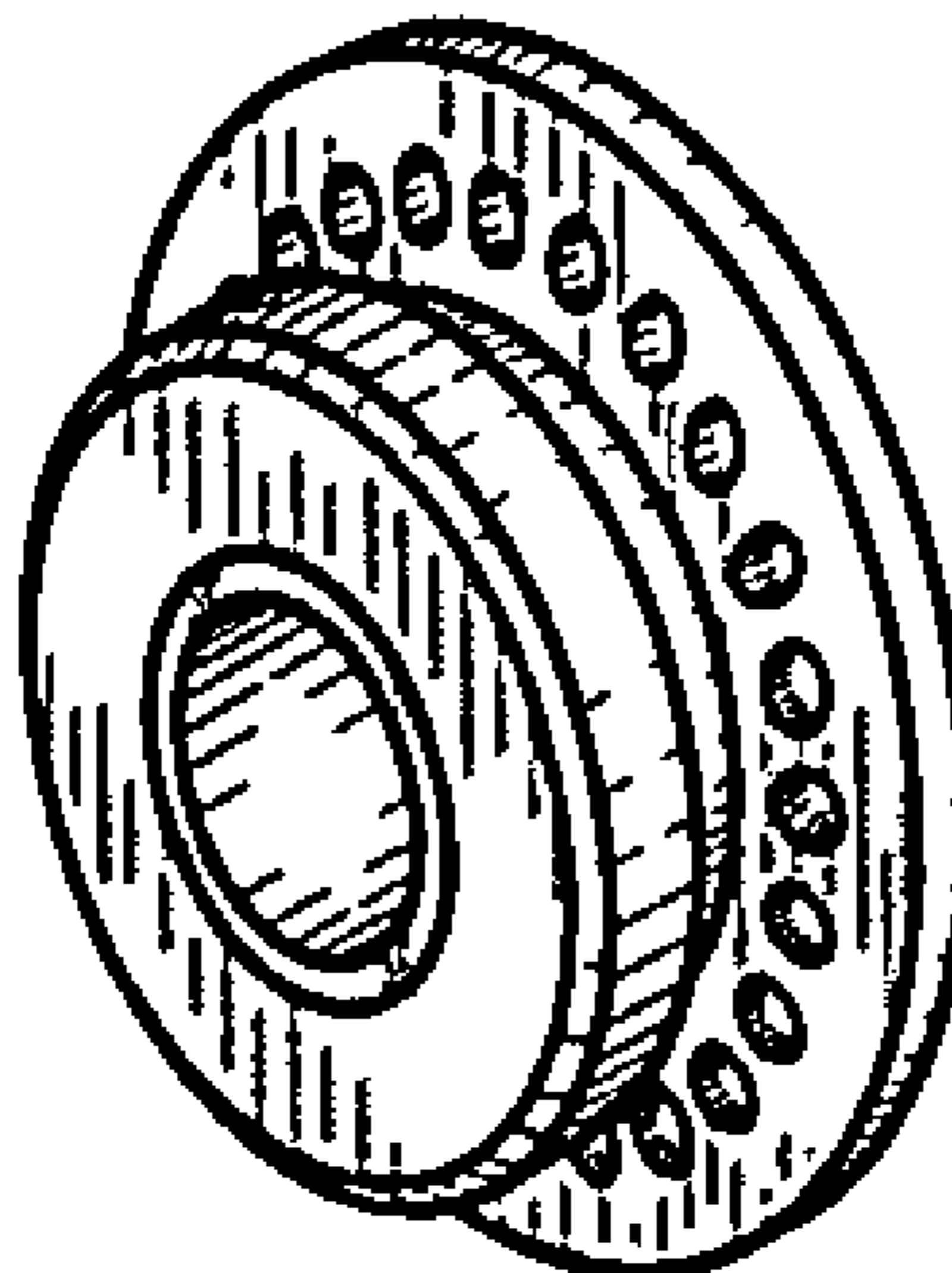

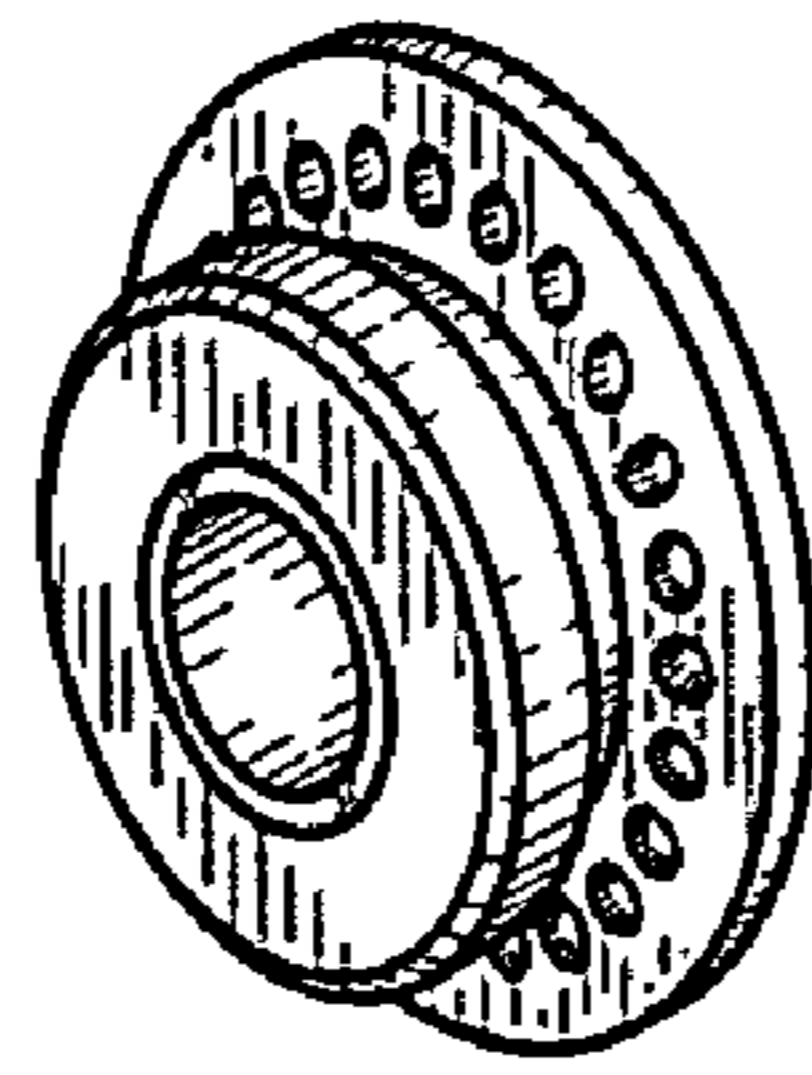

FIG. 1

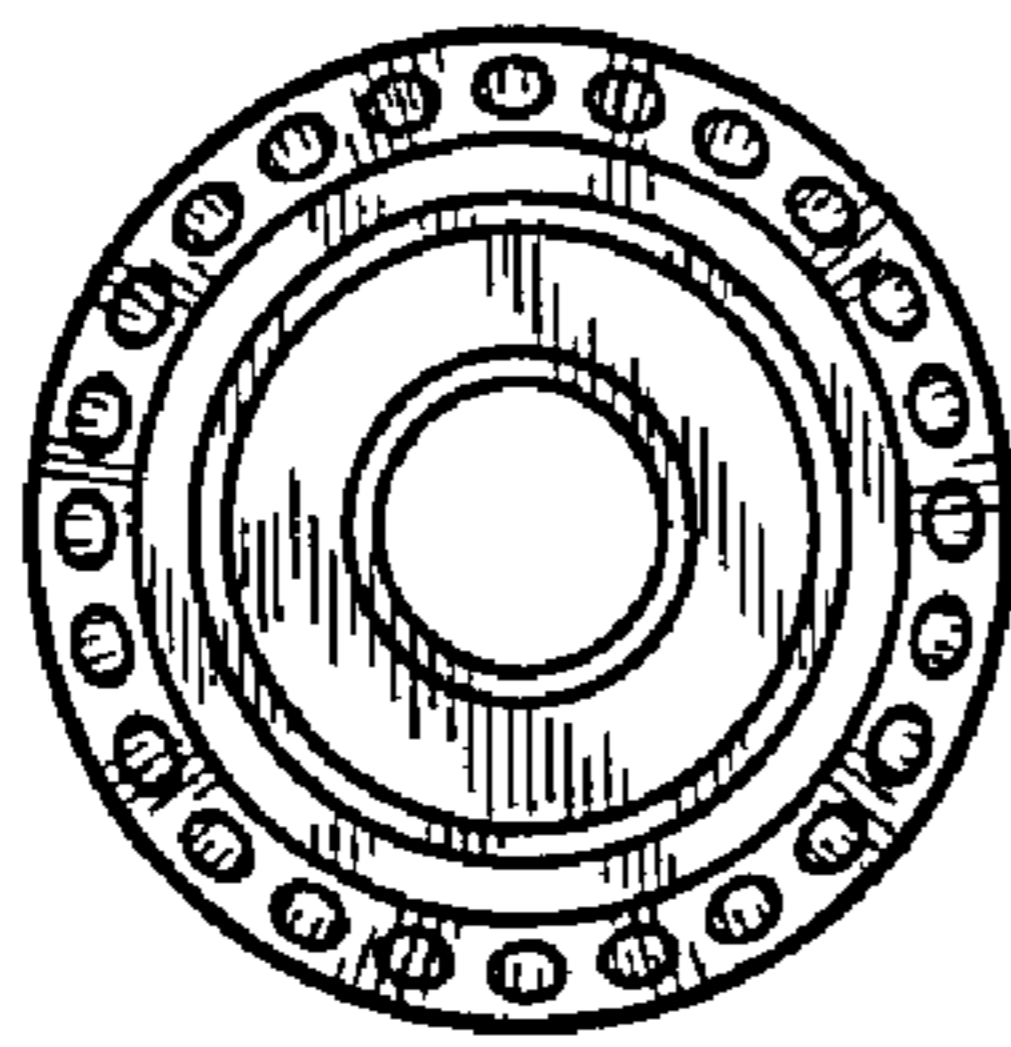

FIG. 2

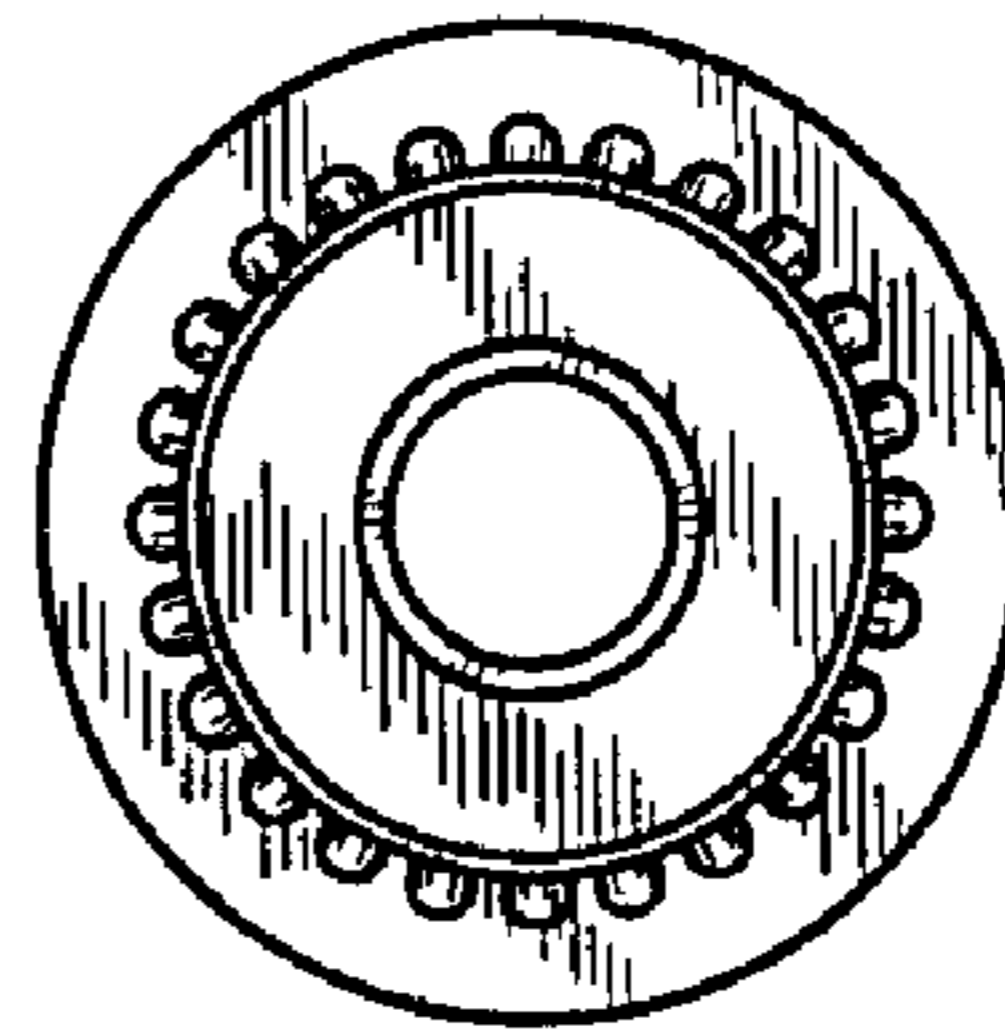

FIG. 3

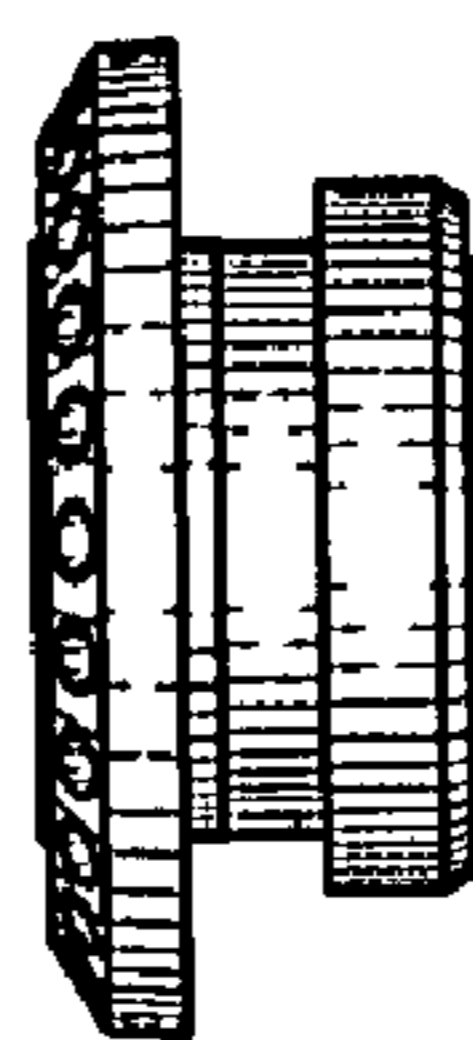

FIG. 4

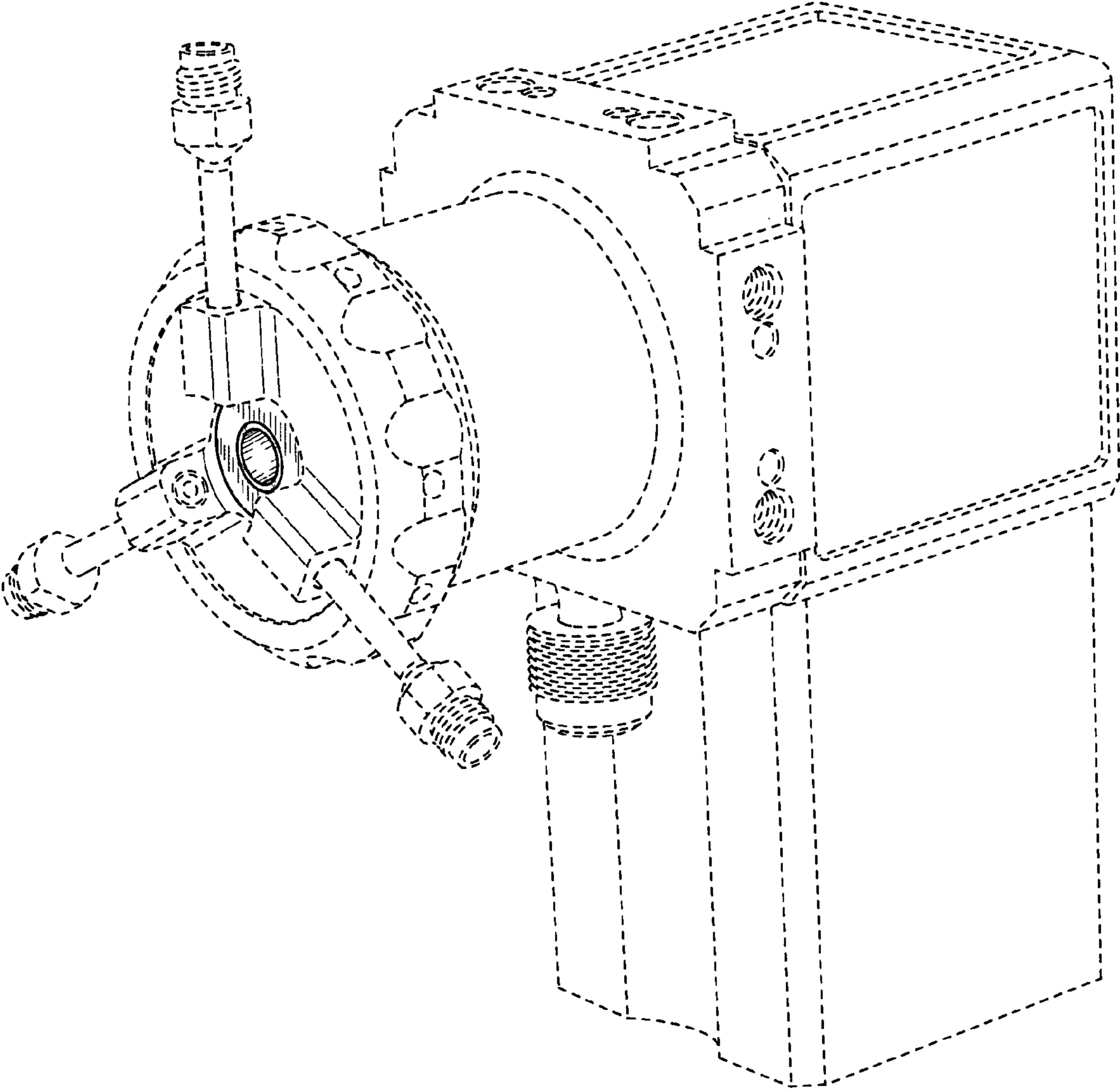

FIG. 5

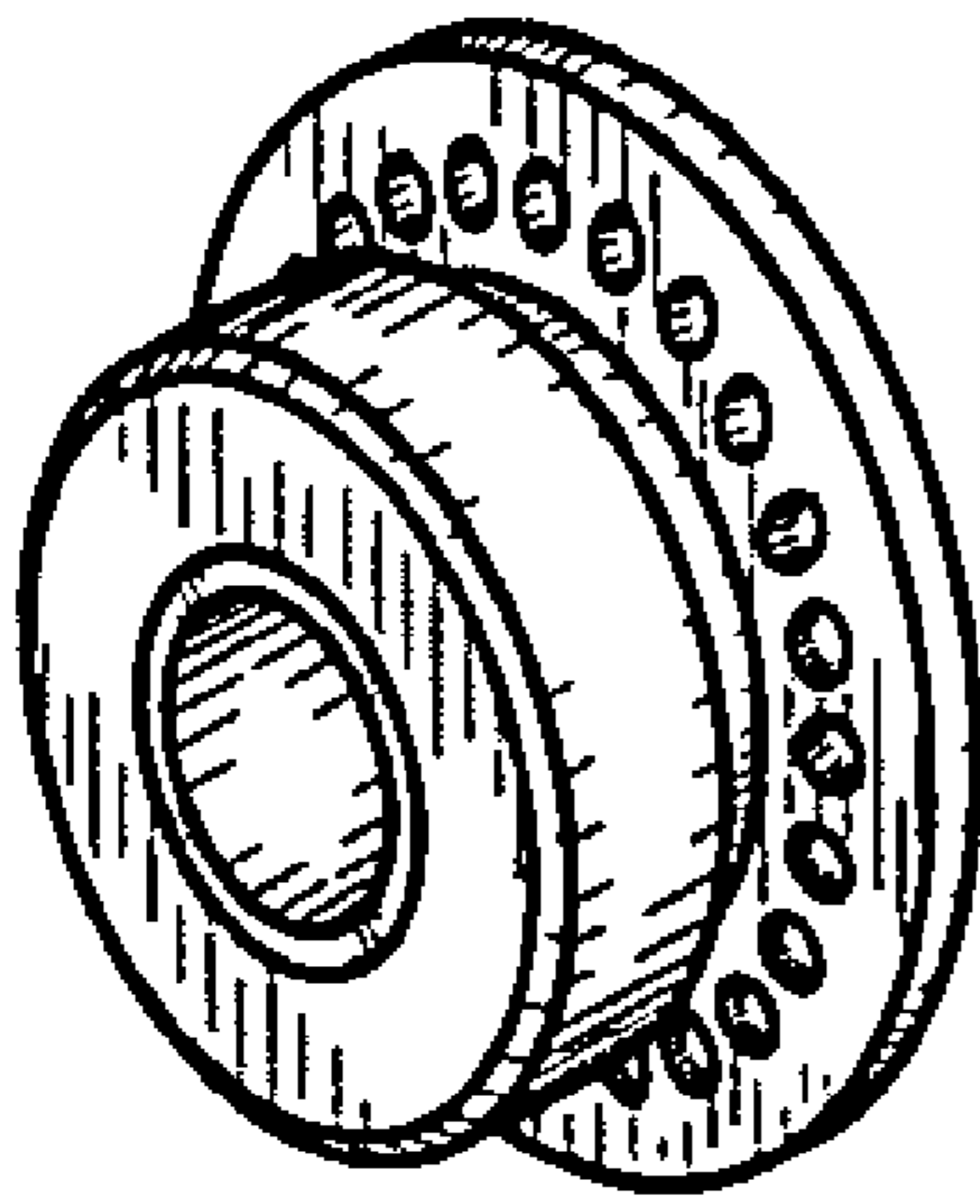

FIG. 6

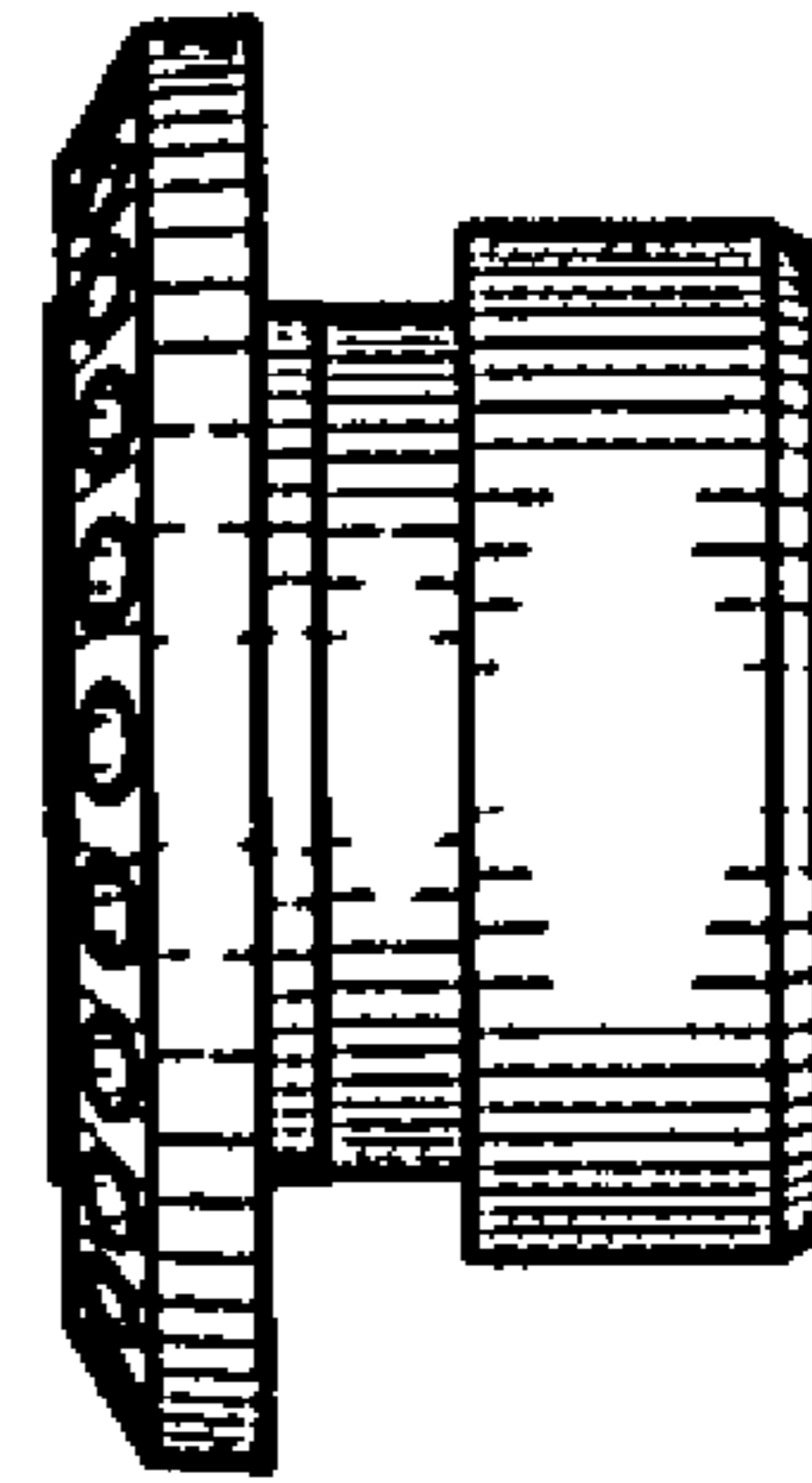

FIG. 7

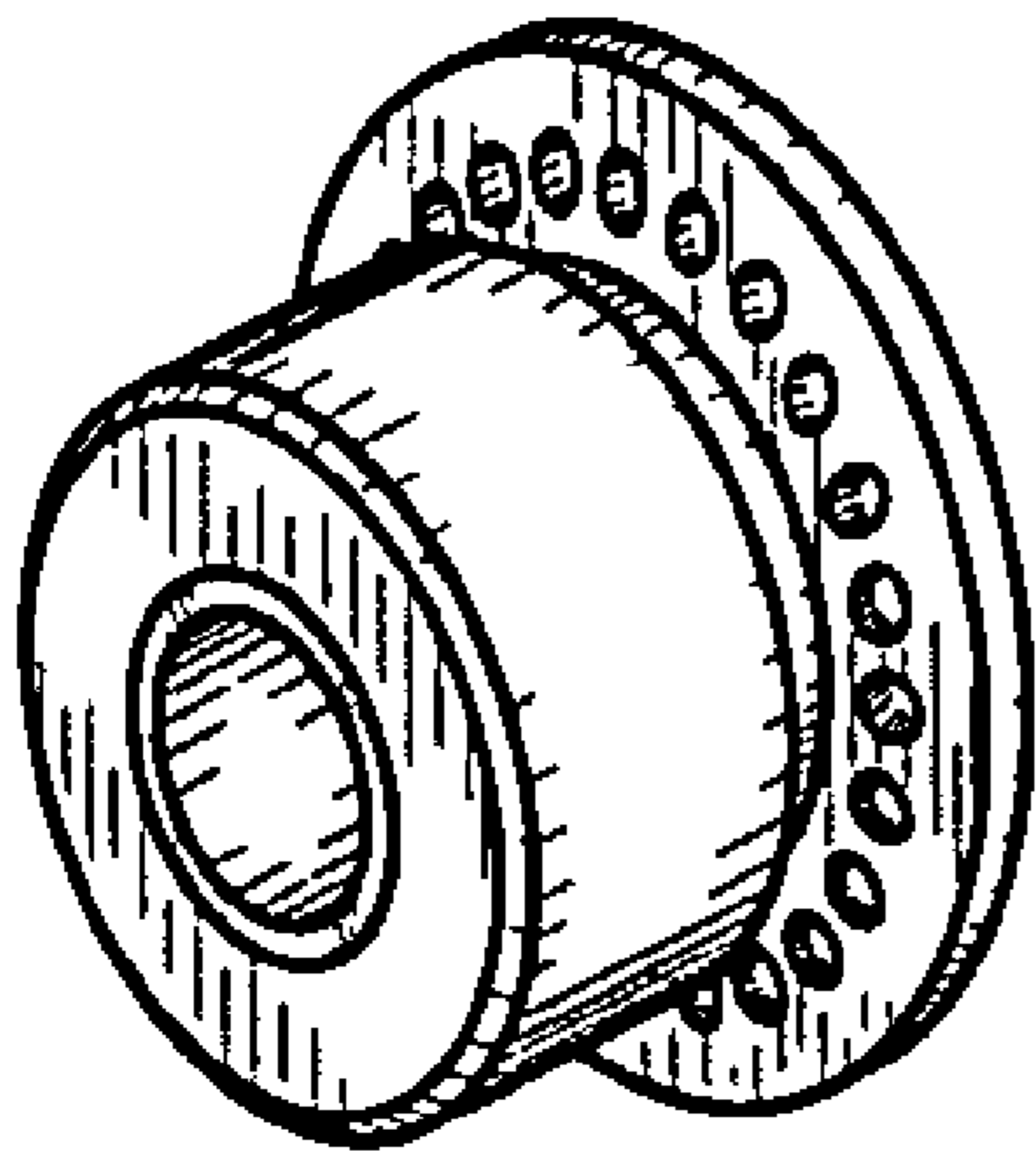

FIG. 8

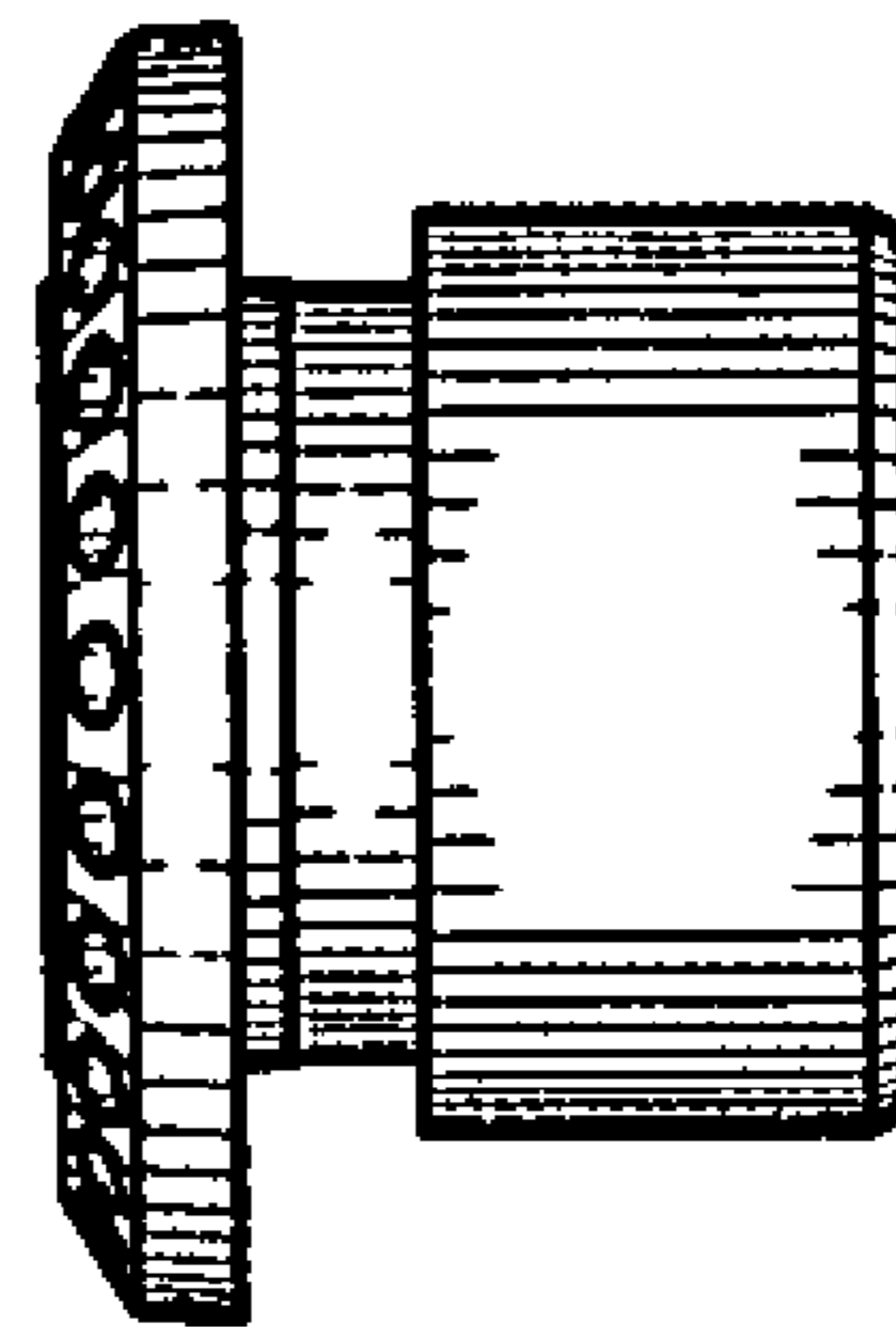

FIG. 9