



US00D562825S

(12) **United States Design Patent**  
**Fitch et al.**

(10) **Patent No.:** **US D562,825 S**  
(45) **Date of Patent:** **\*\* Feb. 26, 2008**

(54) **OPTICAL READING DEVICE**

(75) Inventors: **Timothy Robert Fitch**, Syracuse, NY (US); **Garth R. Gibby**, Beaverton, OR (US); **Scott W. Osiecki**, Skaneateles, NY (US); **Donwoong Kang**, Camillus, NY (US)

(73) Assignee: **Hand Held Products, Inc.**, Skaneateles Falls, NY (US)

(\*\*) Term: **14 Years**

(21) Appl. No.: **29/256,055**

(22) Filed: **Mar. 15, 2006**

(51) **LOC (8) Cl.** ..... **14-02**

(52) **U.S. Cl.** ..... **D14/426**

(58) **Field of Classification Search** ..... D14/428,  
D14/420, 426; 382/312, 313, 321; 235/472.01,  
235/462.45, 462.43; 250/568  
See application file for complete search history.

(56) **References Cited**

U.S. PATENT DOCUMENTS

D362,435 S *	9/1995	Charych et al. ....	D14/428
D388,076 S *	12/1997	Swift et al. ....	D14/428
D400,199 S *	10/1998	Fitch et al. ....	D14/428
D405,077 S *	2/1999	Urushihata et al. ....	D14/428
D414,171 S *	9/1999	Swift et al. ....	D14/428
D418,500 S *	1/2000	Giordano et al. ....	D14/429
6,223,988 B1 *	5/2001	Batterman et al. ....	235/472.01
D456,810 S *	5/2002	Schlieffers .....	D14/428

D470,145 S *	2/2003	Schlieffers et al. ....	D14/428
6,517,003 B2 *	2/2003	Vassura et al. ....	235/472.01
6,824,060 B2 *	11/2004	Barkan .....	235/462.25
6,883,713 B2 *	4/2005	Schlieffers .....	235/472.01

\* cited by examiner

*Primary Examiner*—M. H. Tung

*Assistant Examiner*—Susan Moon Lee

(57) **CLAIM**

The ornamental design for an optical reading device, as shown and described.

**DESCRIPTION**

FIG. 1 is a top perspective view of an optical reading device.

FIG. 2 is a front view of the optical reading device shown in FIG. 1.

FIG. 3 is a rear view of the optical reading device shown in FIG. 1.

FIG. 4 is a first side view of the optical reading device shown in FIG. 1.

FIG. 5 is a second side view, opposite that of FIG. 4, of the optical reading device shown in FIG. 1.

FIG. 6 is a bottom view of the optical reading device shown in FIG. 1; and,

FIG. 7 is a top view of the optical reading device shown in FIG. 1.

The portions depicted in broken line are for illustrative purposes only and form no part of the claimed design.

**1 Claim, 7 Drawing Sheets**

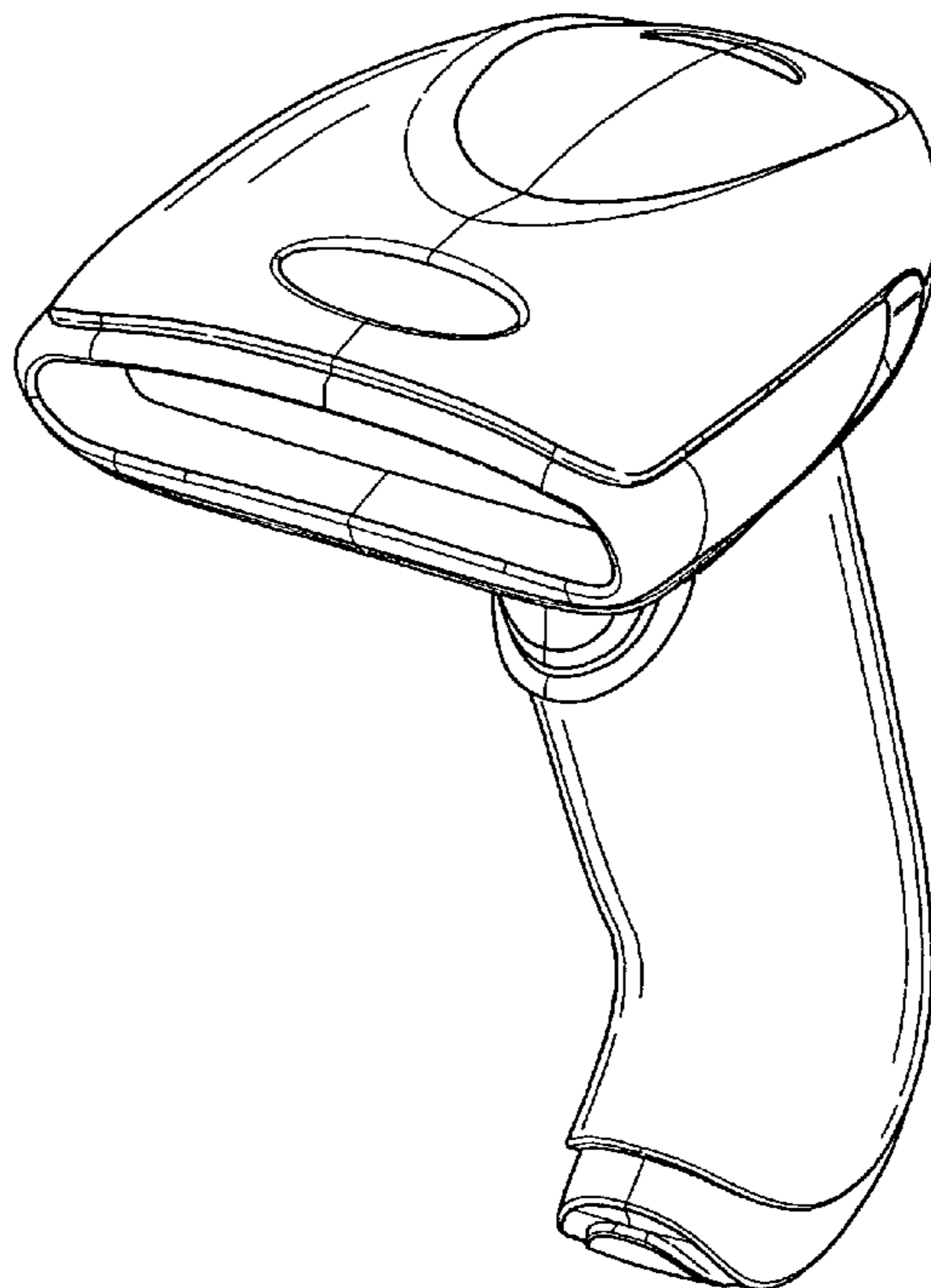

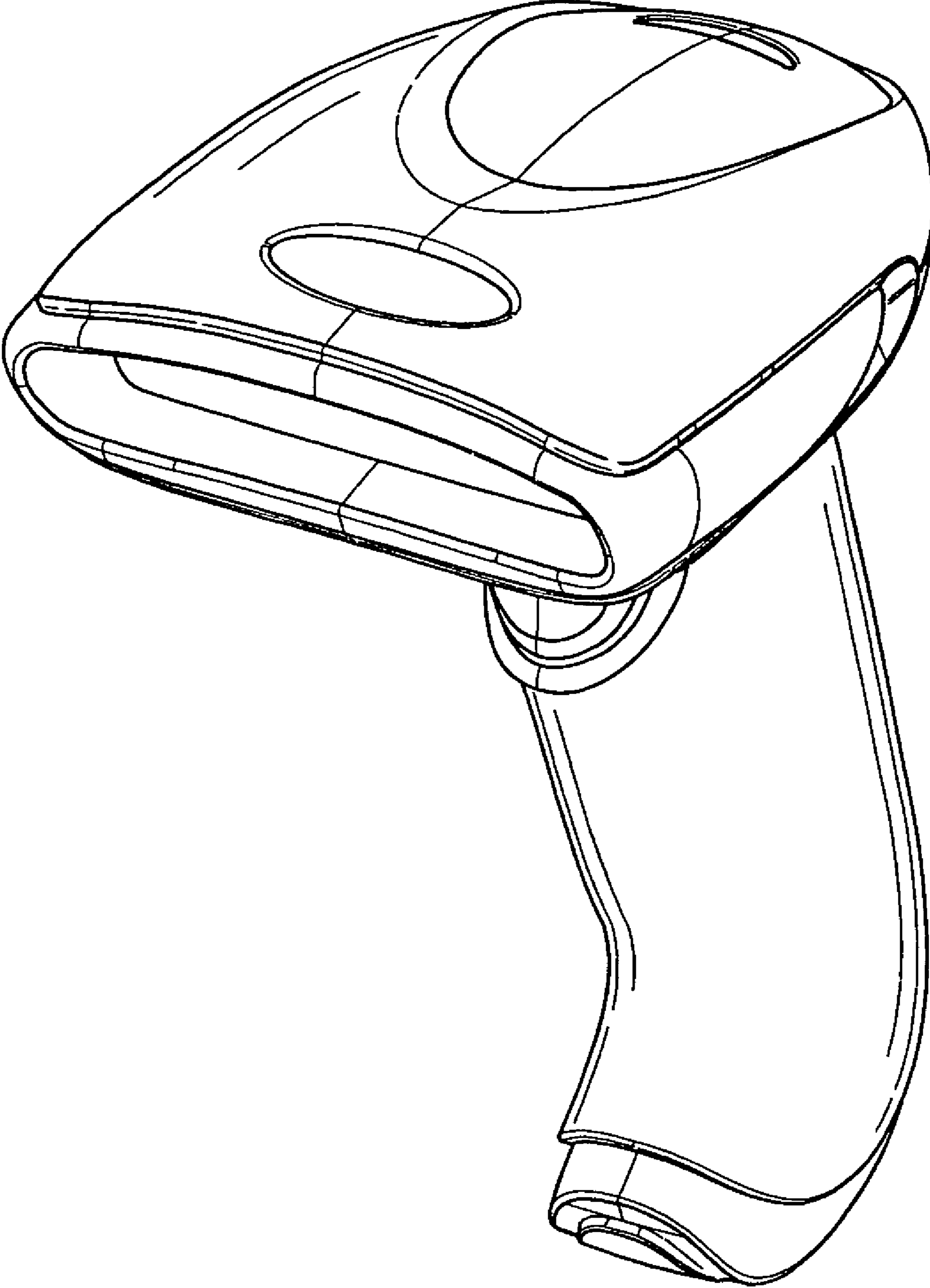

FIG. 1

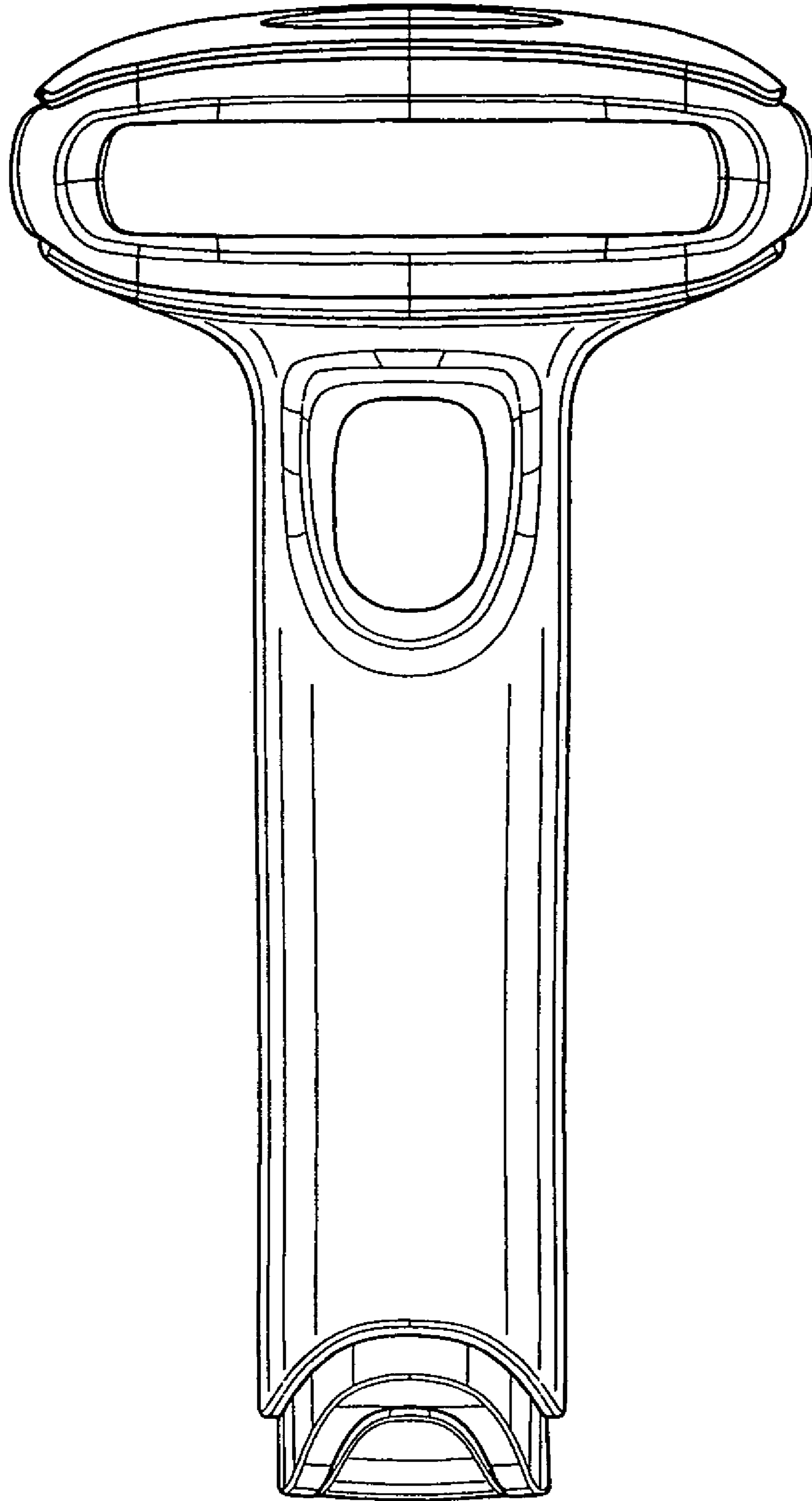

FIG. 2

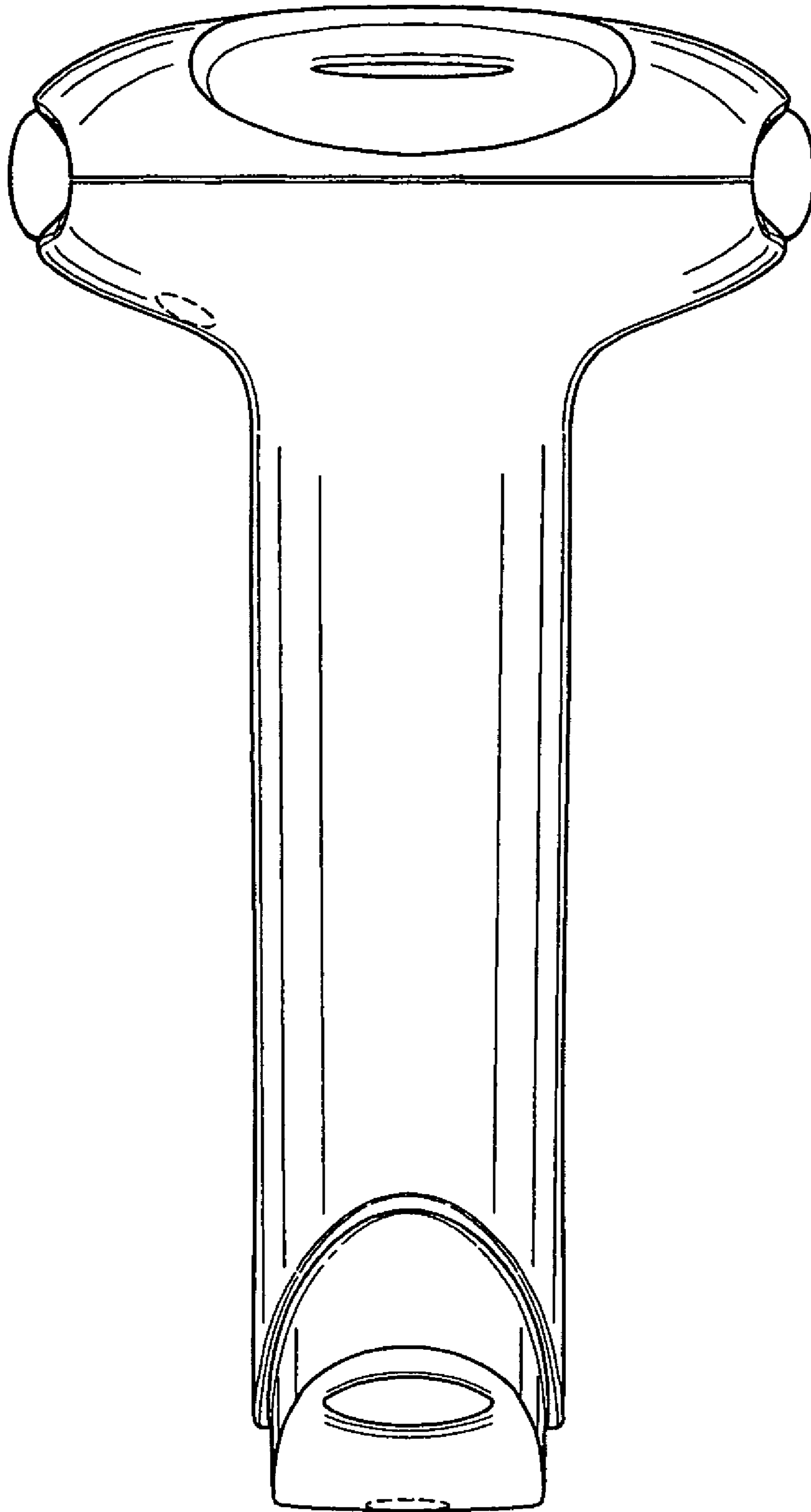

FIG. 3

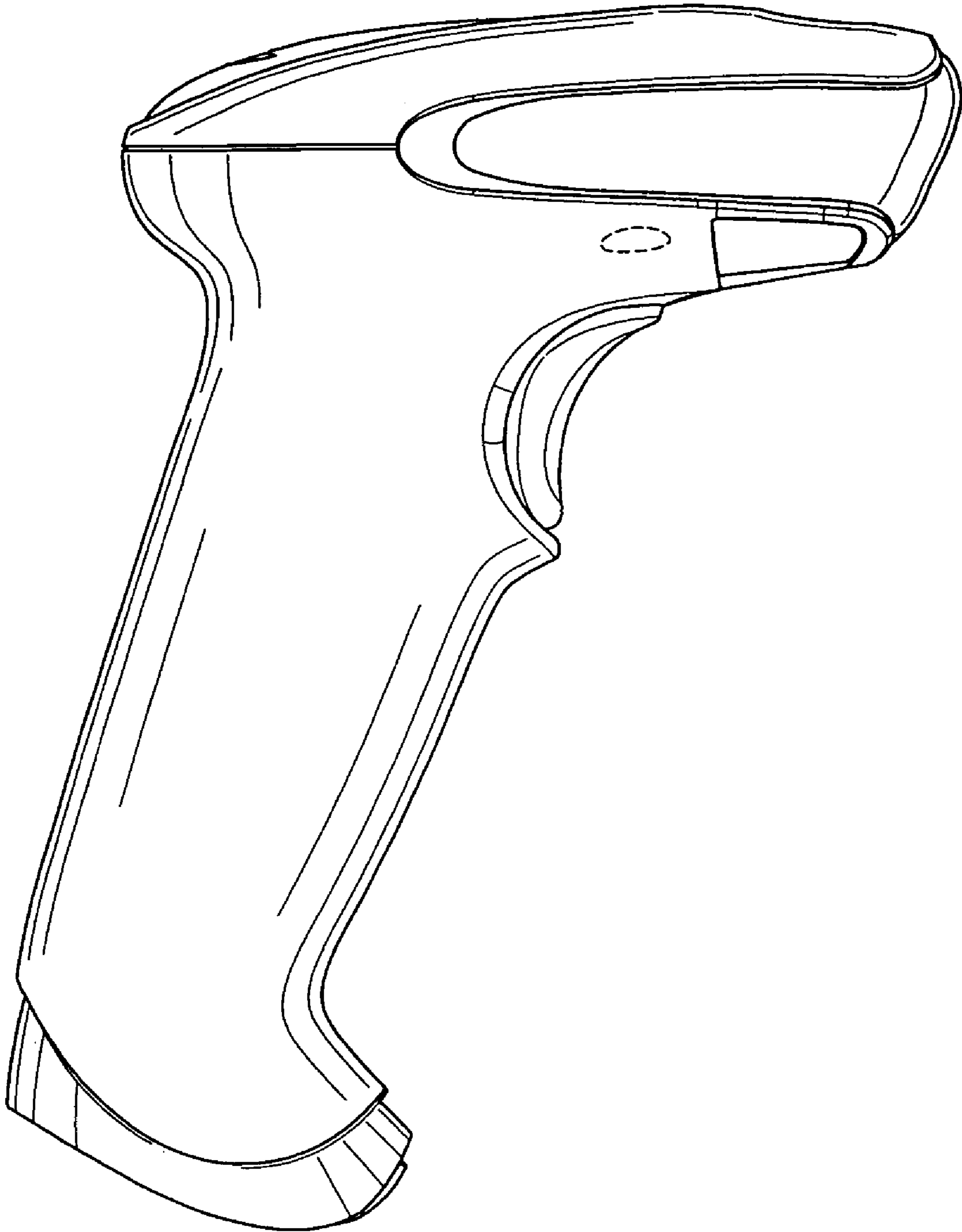

FIG. 4

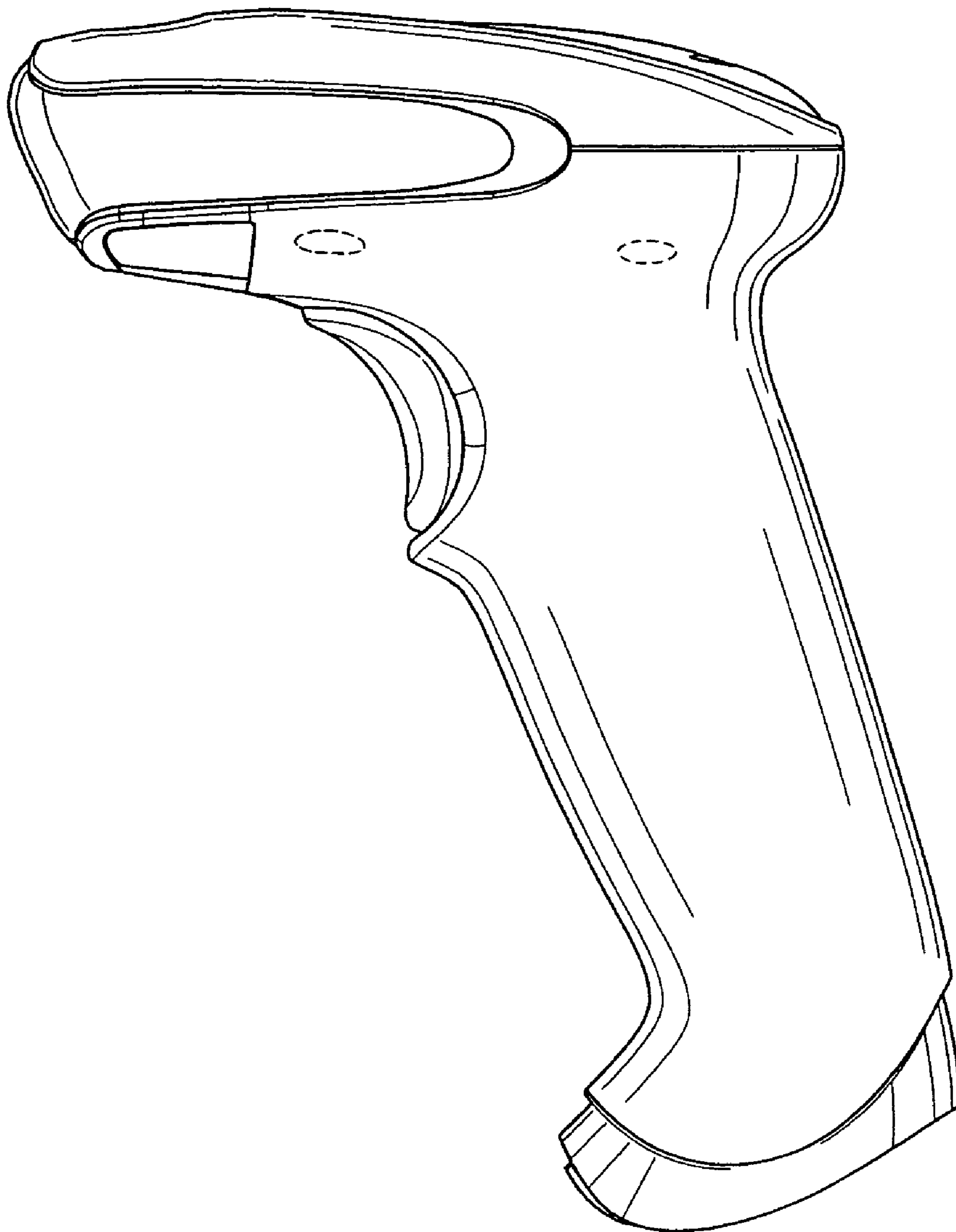

FIG. 5

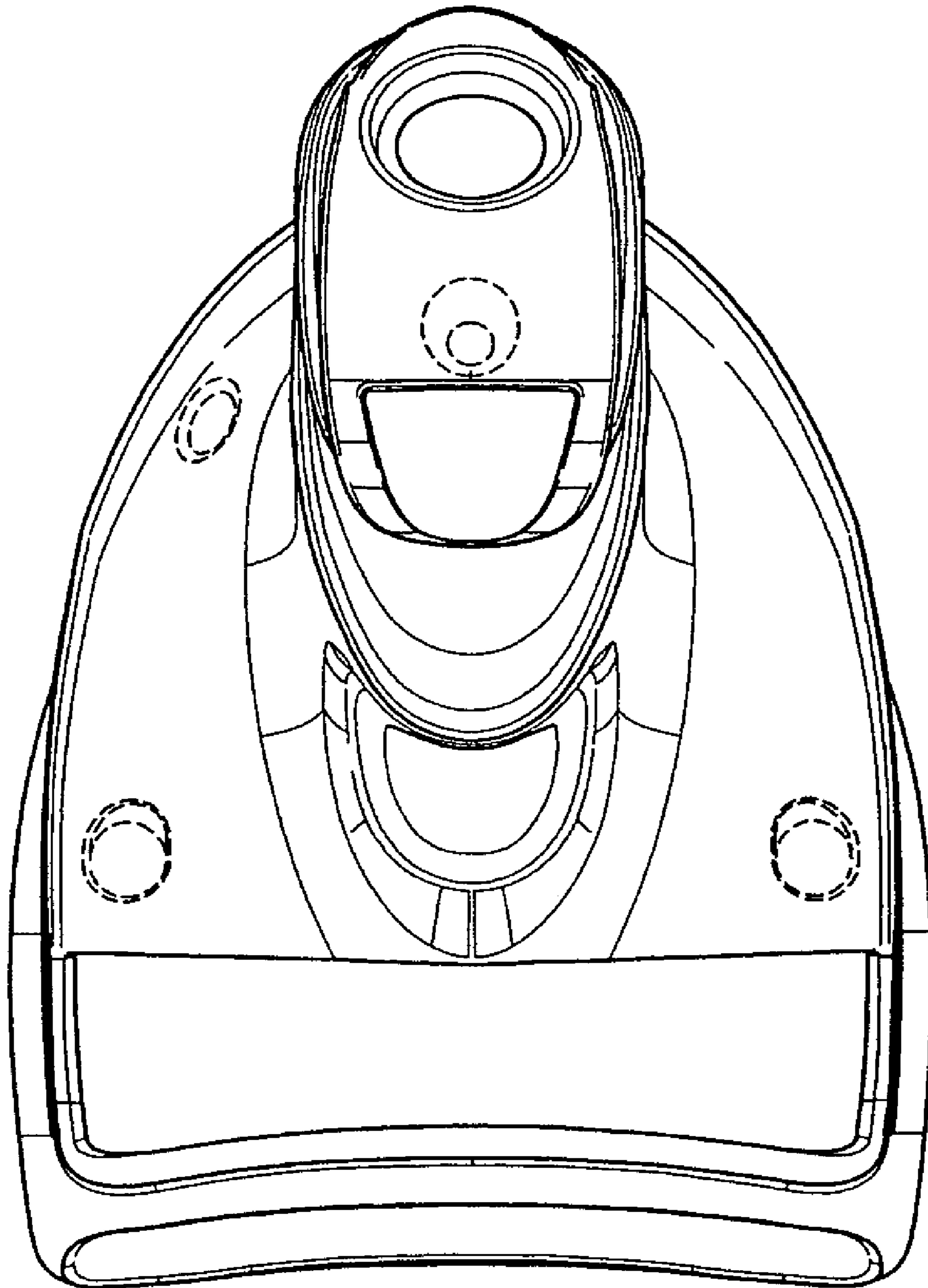

FIG. 6

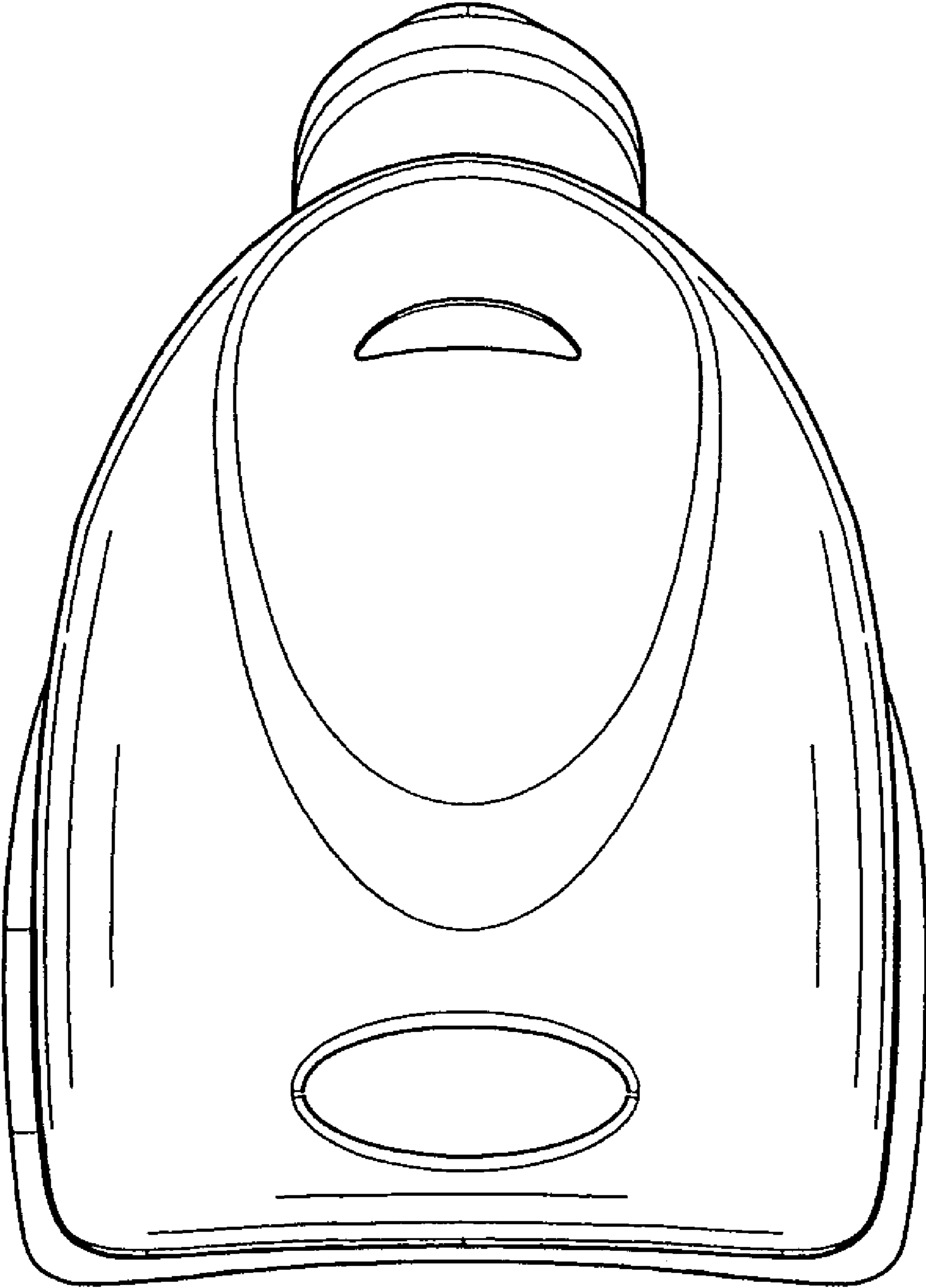

FIG. 7