



US00D562805S

(12) **United States Design Patent**
Tokuno

(10) **Patent No.:** **US D562,805 S**

(45) **Date of Patent:** **** Feb. 26, 2008**

(54) **SPEAKER**

(75) Inventor: **Masato Tokuno**, Tokyo (JP)

(73) Assignee: **IDEA International Co., Ltd.**, Tokyo (JP)

(**) Term: **14 Years**

(21) Appl. No.: **29/266,441**

(22) Filed: **Sep. 21, 2006**

(51) **LOC (8) Cl.** **14-01**

(52) **U.S. Cl.** **D14/216; D14/217**

(58) **Field of Classification Search** D14/204,
D14/207, 209-217, 168, 172, 496; 181/143-144,
181/147-148, 150, 157, 198-199, 151, 153;
381/300-302, 306, 333, 345, 361-364, 386-388,
381/332, 336

See application file for complete search history.

(56) **References Cited**

U.S. PATENT DOCUMENTS

D242,360 S *	11/1976	Kossen, Jr.	D14/213
5,319,164 A *	6/1994	Shen	181/150
5,444,194 A *	8/1995	Reinke	181/153
D478,062 S *	8/2003	Stephens	D14/207
D518,029 S *	3/2006	Tsang	D14/216

* cited by examiner

Primary Examiner—Nanda Bondade
(74) *Attorney, Agent, or Firm*—Wenderoth, Lind & Ponack L.L.P.

(57) **CLAIM**

The ornamental design for a speaker, as shown and described.

DESCRIPTION

FIG. 1 is a front view of the speaker;
FIG. 2 is a rear view of the speaker of FIG. 1;
FIG. 3 is a right side view of the speaker of FIG. 1;
FIG. 4 is a left side view of the speaker of FIG. 1;
FIG. 5 is a top plan view of the speaker of FIG. 1;
FIG. 6 is a bottom plan view of the speaker of FIG. 1;
FIG. 7 is a top perspective view of the speaker of FIG. 1;
FIG. 8 is a bottom perspective view of FIG. 1;
FIG. 9 is a sectional view taken along line 9—9 in FIG. 5;
and,
FIG. 10 is a top perspective view thereof.

The broken line showing on the drawing disclosure is for illustrative purposes only and forms no part of the claimed design.

1 Claim, 5 Drawing Sheets

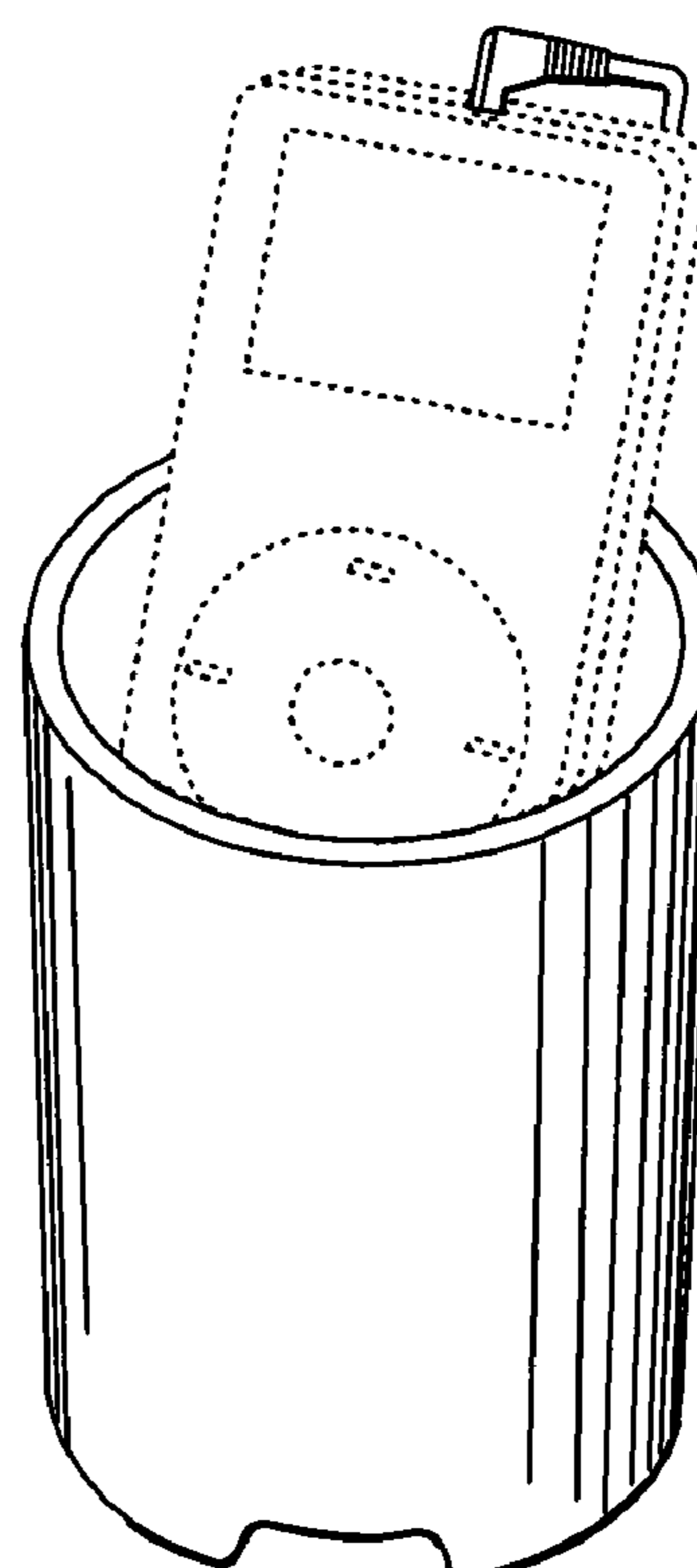
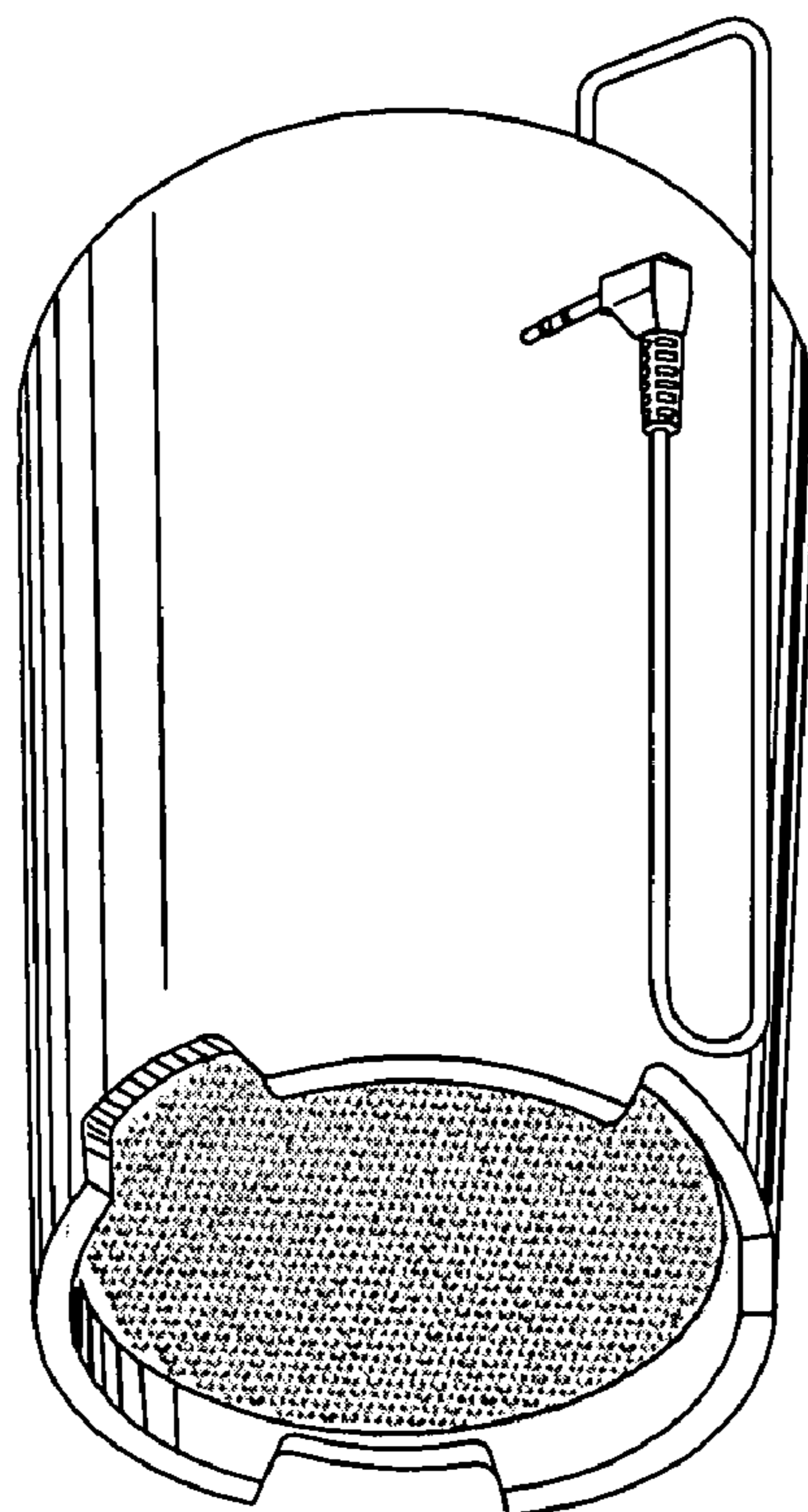

FIG. 1

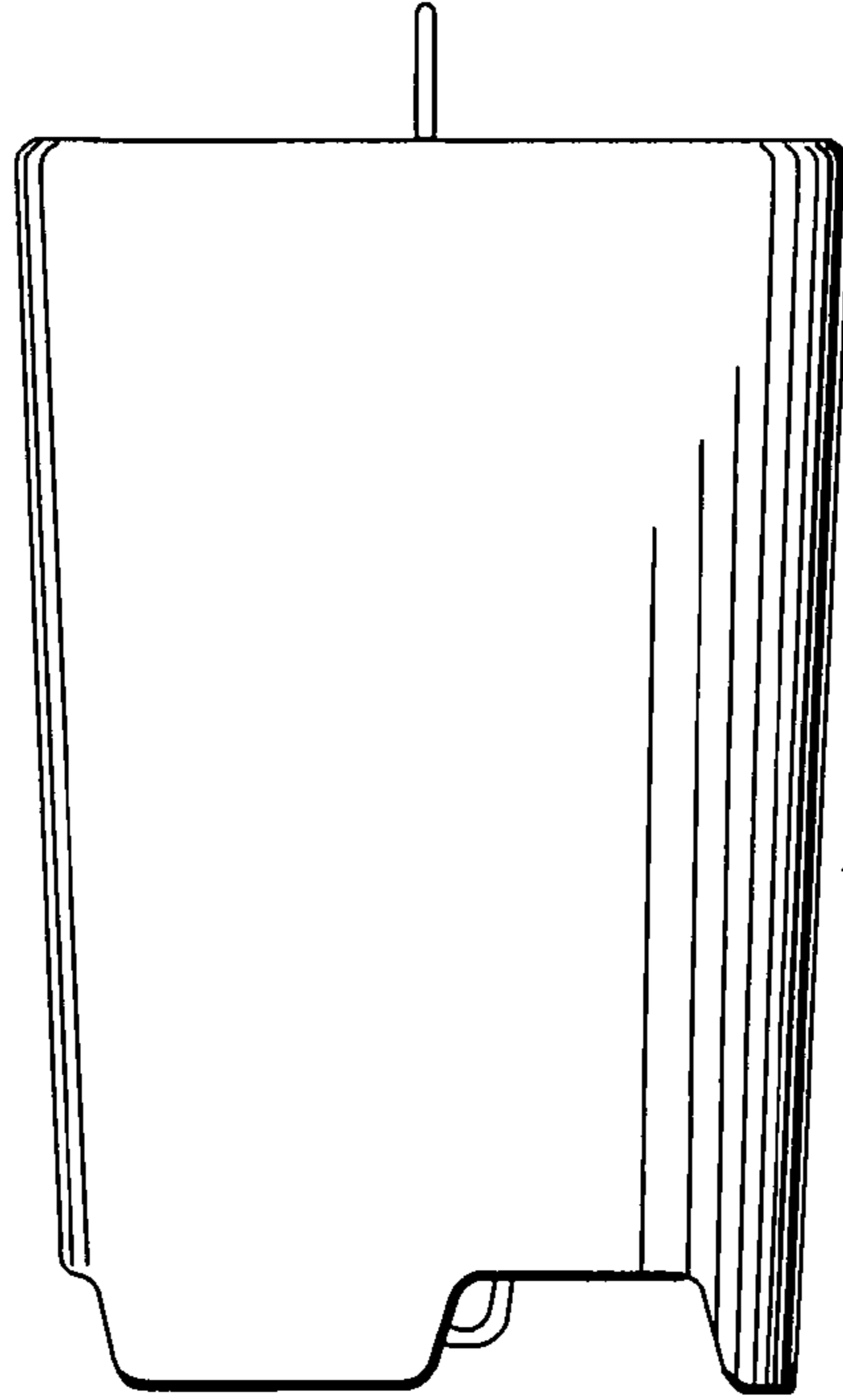

FIG. 2

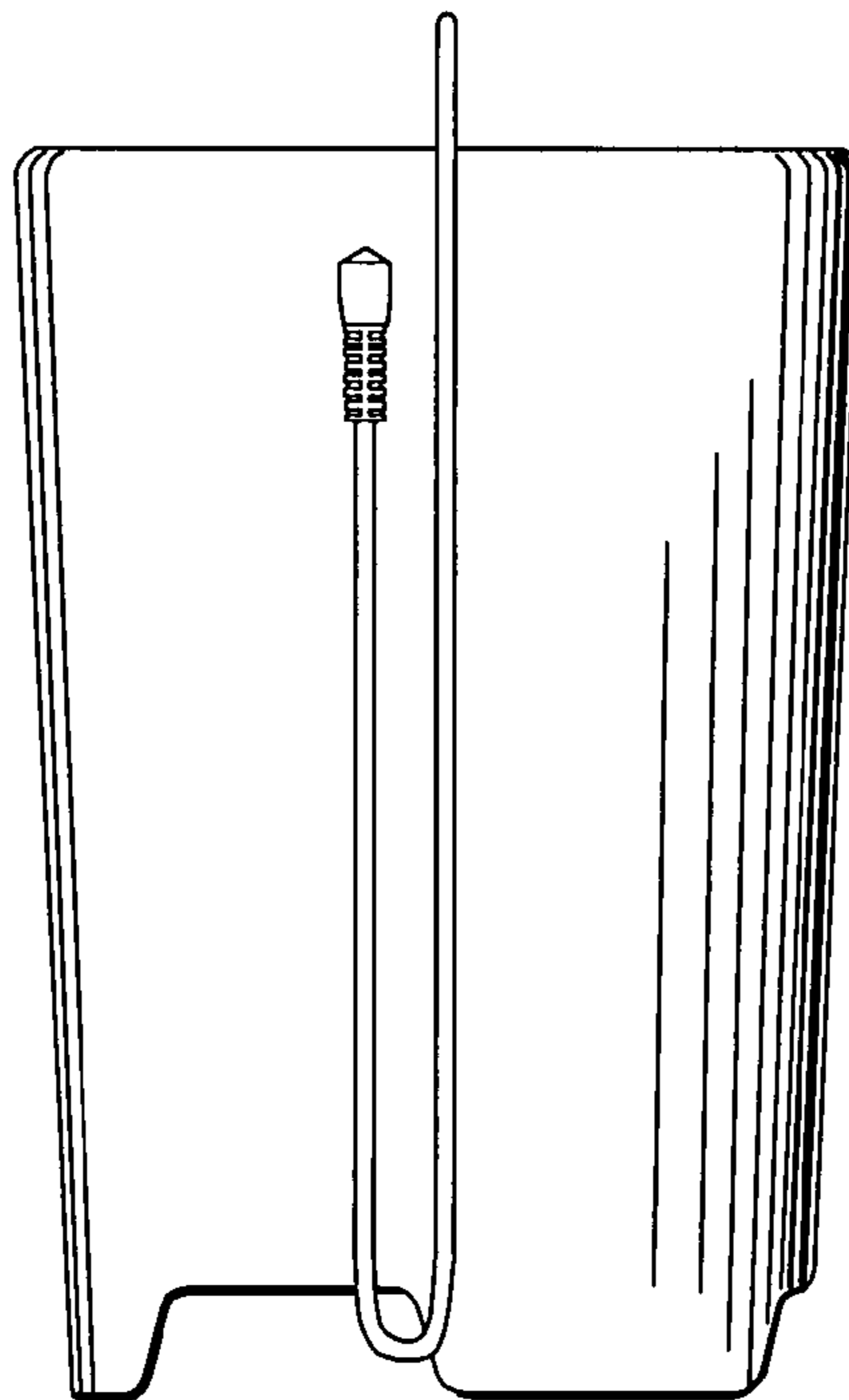

FIG. 3

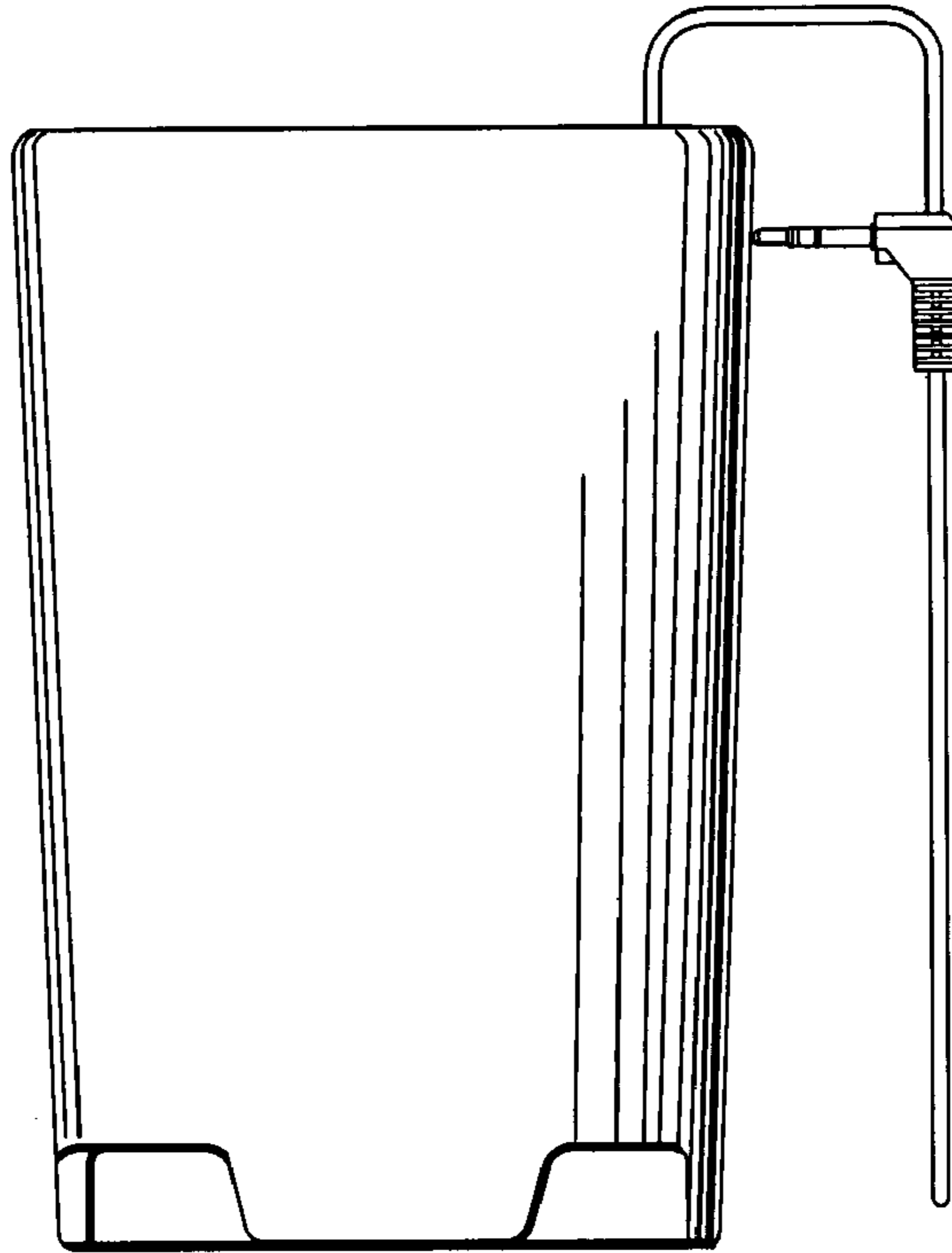

FIG. 4

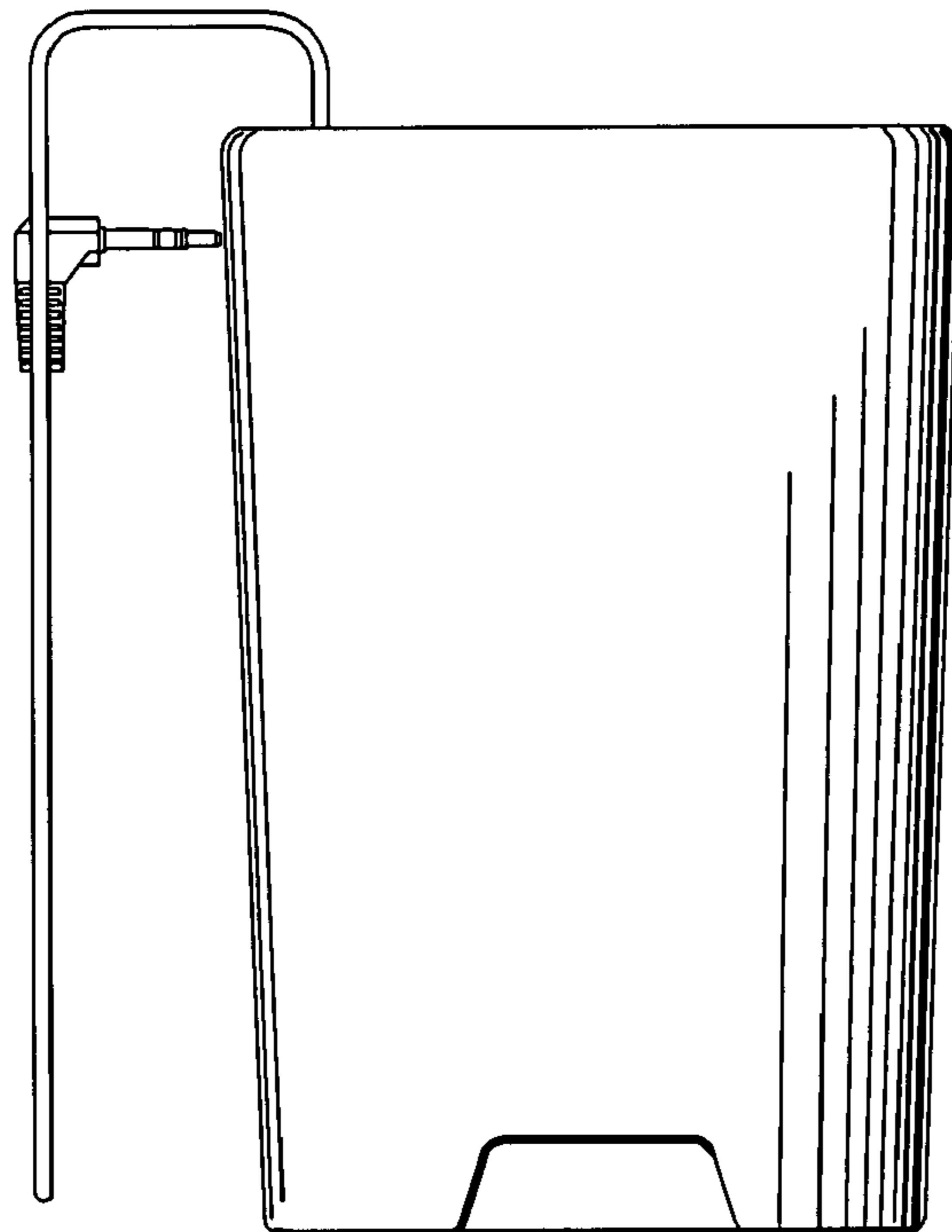

FIG. 5

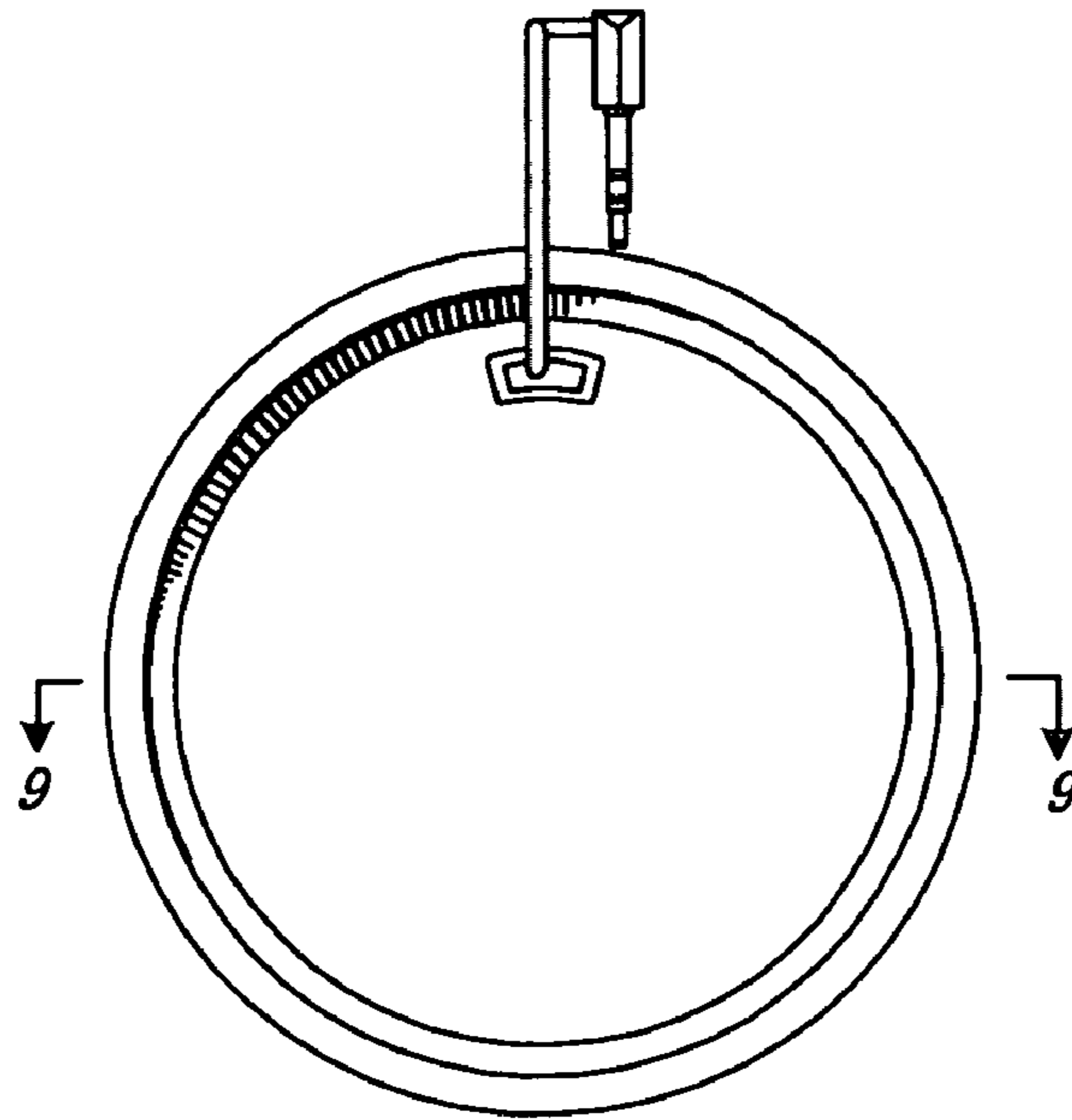

FIG. 6

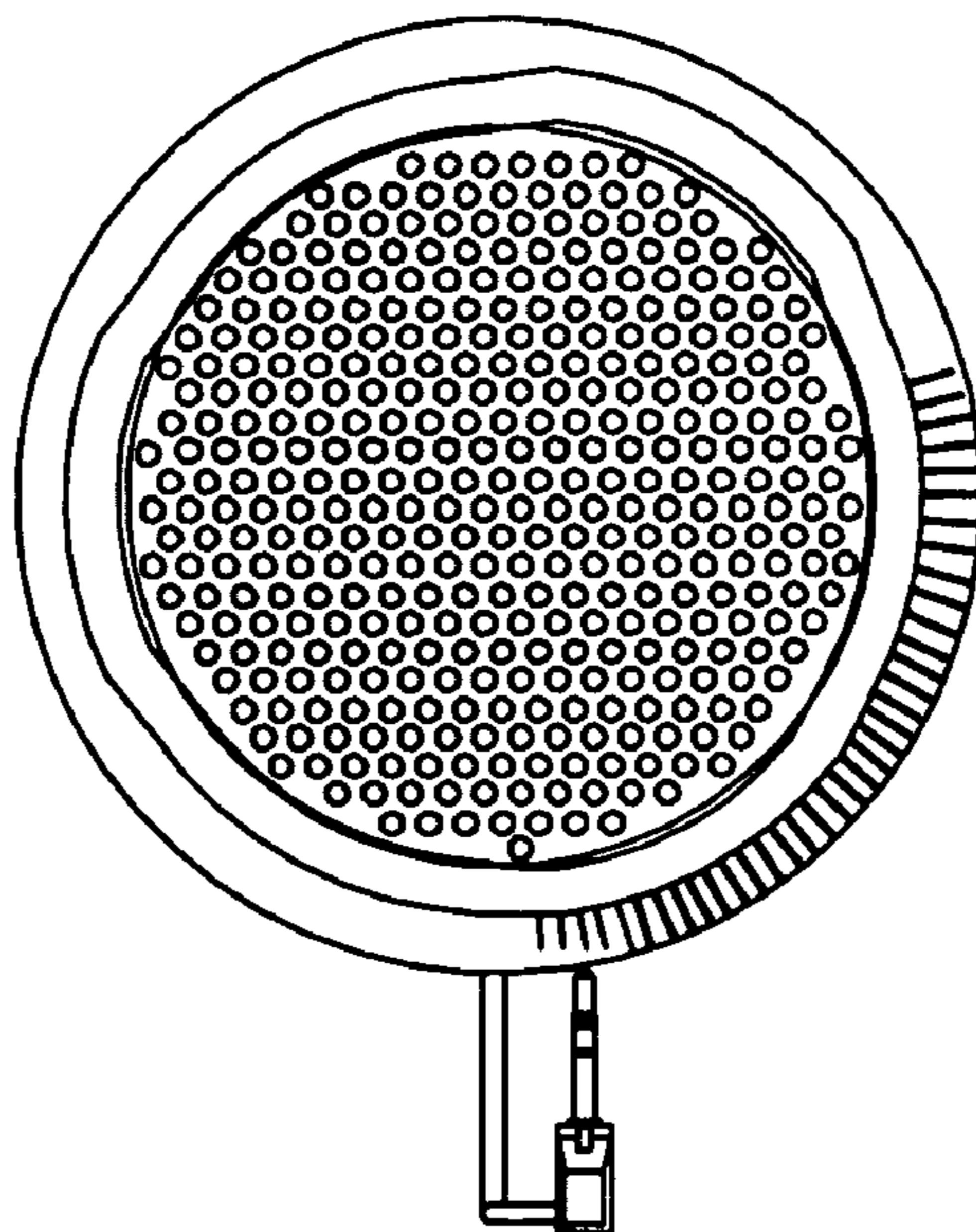

FIG. 7

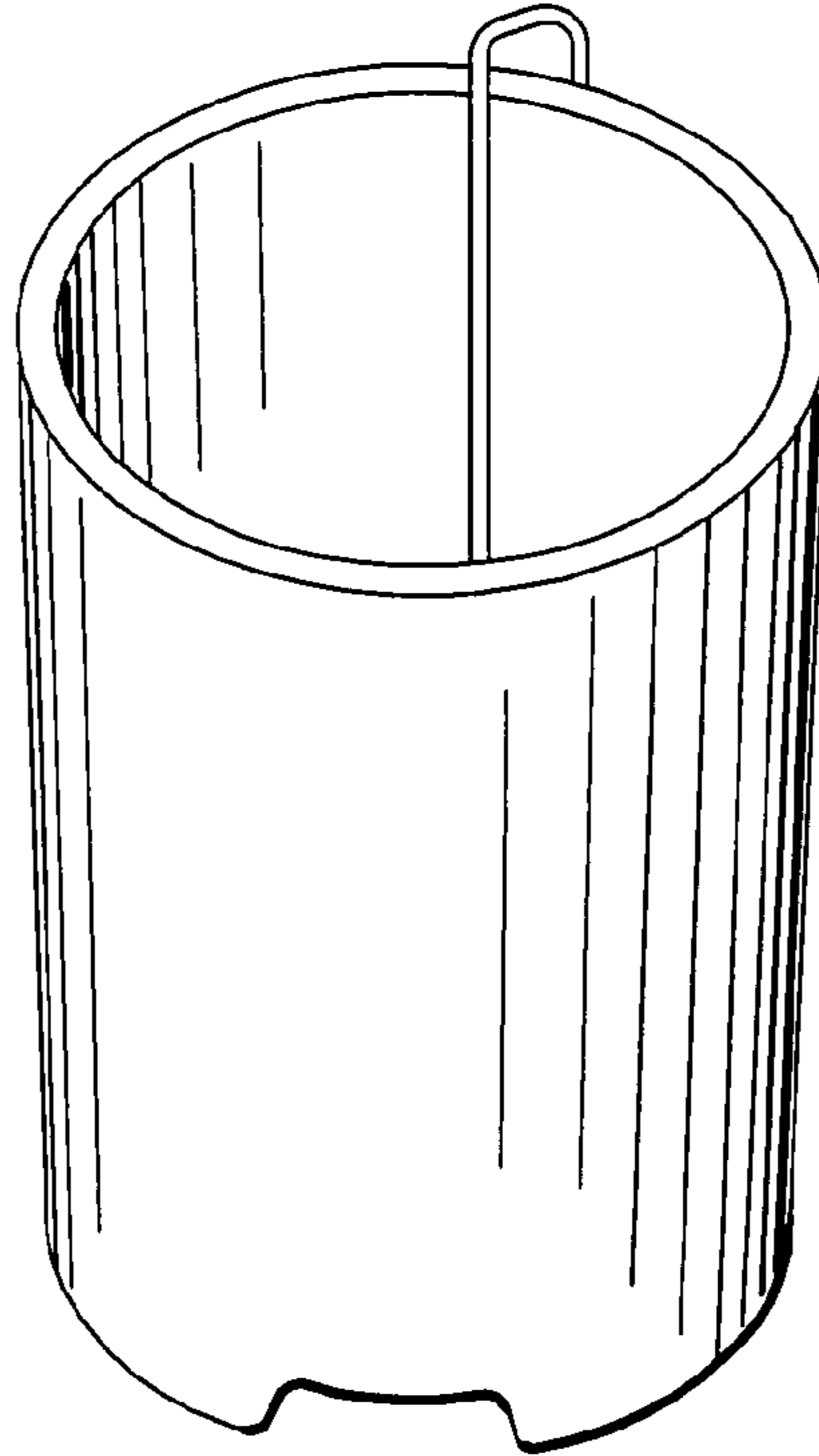

FIG. 8

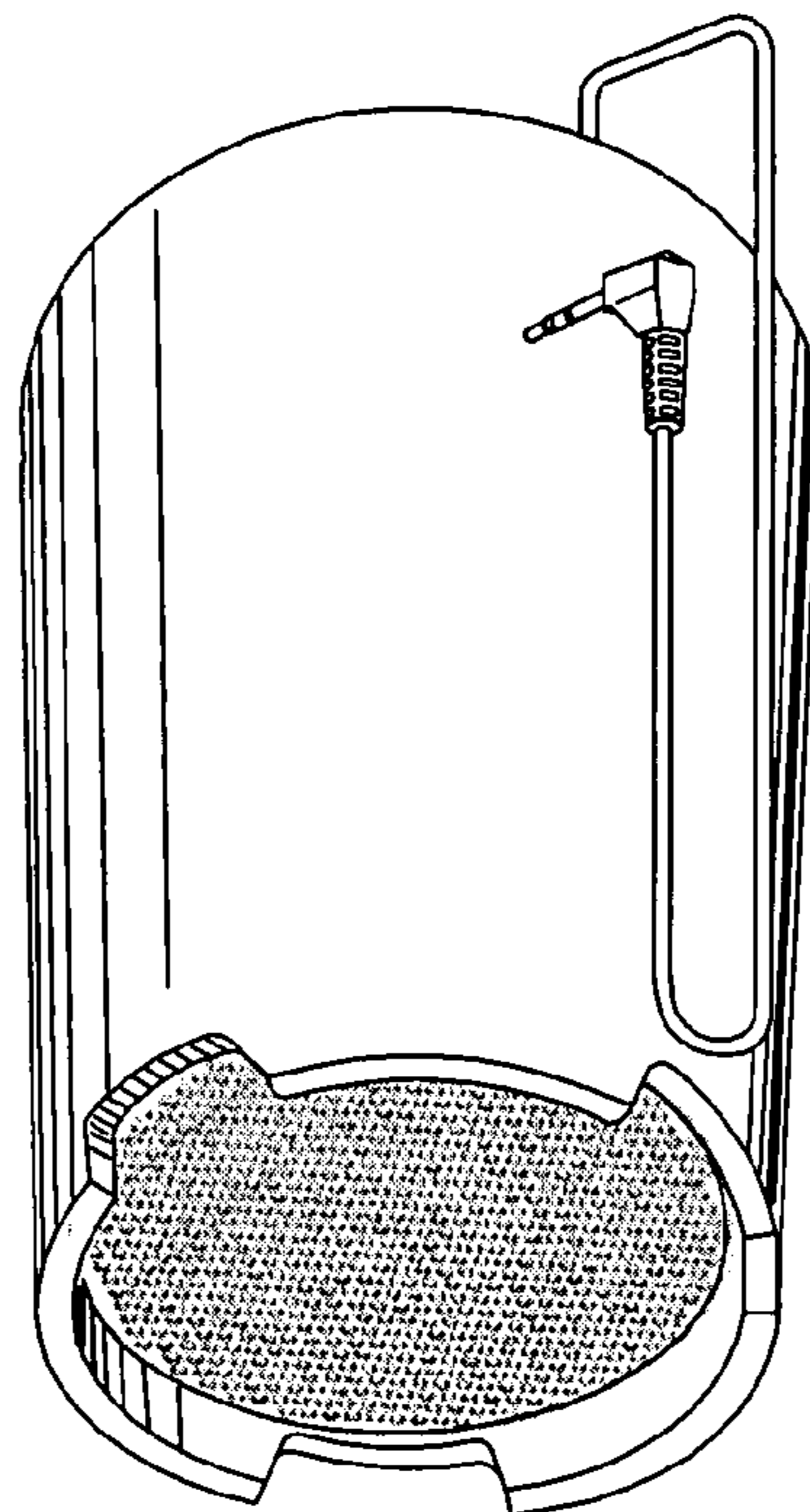

FIG. 9

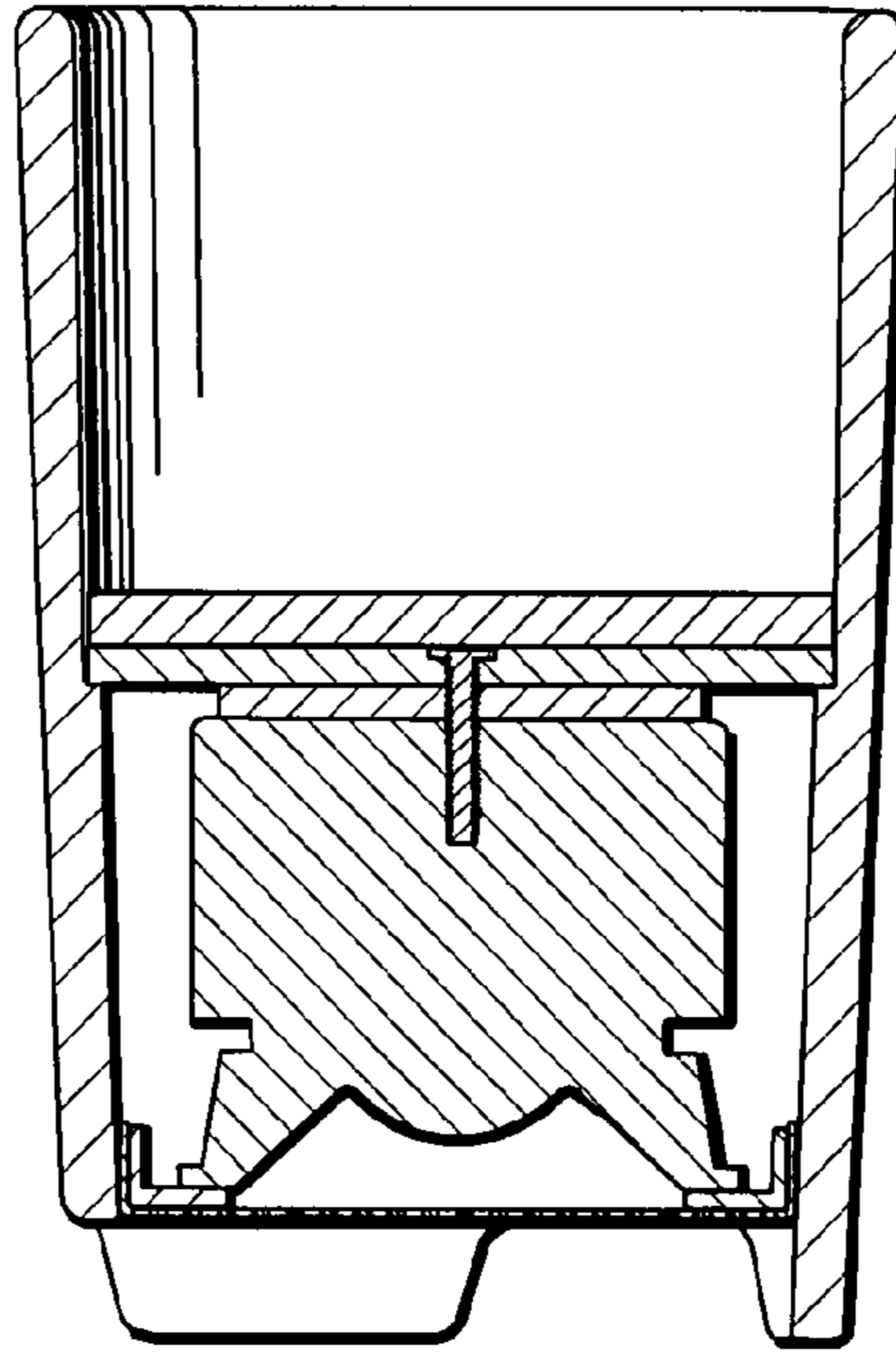

FIG. 10

