



US00D562688S

(12) **United States Design Patent**  
**Mühlhausen et al.**

(10) **Patent No.:** **US D562,688 S**

(45) **Date of Patent:** **\*\* Feb. 26, 2008**

(54) **BOTTLE**

(75) Inventors: **Hans-Georg Mühlhausen**, Dusseldorf (DE); **Matthias Reimann**, Dusseldorf (DE)

(73) Assignee: **Henkel Kommanditgesellschaft auf Aktien**, Dusseldorf (DE)

(\*\*) Term: **14 Years**

(21) Appl. No.: **29/271,184**

(22) Filed: **Jan. 11, 2007**

(30) **Foreign Application Priority Data**

Jul. 13, 2006 (EM) ..... 000560263

(51) **LOC (8) Cl.** ..... **09-01**

(52) **U.S. Cl.** ..... **D9/534**

(58) **Field of Classification Search** ..... D9/516,  
D9/523, 525, 528, 529, 531, 534, 540, 575;  
215/14, 200, 217, 218, 223, 241, 379, 382-385,  
215/396, 398; 220/200, 260, 890; 222/92,  
222/109, 210, 212, 205; D23/211, 211.1,  
D23/211.2

See application file for complete search history.

(56) **References Cited**

**U.S. PATENT DOCUMENTS**

- D246,156 S \* 10/1977 Muscatiello et al. .... D9/525
- D273,275 S \* 4/1984 Markis ..... D9/534
- D346,962 S \* 5/1994 Steijns et al. .... D9/523
- D377,902 S \* 2/1997 Marucci ..... D9/534
- D485,185 S \* 1/2004 Versace ..... D9/523
- D510,869 S \* 10/2005 Gross et al. .... D9/523

D529,398 S \* 10/2006 Van Dingenen ..... D9/719

\* cited by examiner

*Primary Examiner*—Stella M. Reid

*Assistant Examiner*—Shanda C. Hill

(74) *Attorney, Agent, or Firm*—Connolly Bove Lodge & Hutz LLP

(57) **CLAIM**

The ornamental design for bottle, as shown and described.

**DESCRIPTION**

FIG. 1 is a perspective view of the bottle showing our design;

FIG. 2 is a front elevational view thereof;

FIG. 3 is a rear elevational view thereof;

FIG. 4 is a left side elevational view thereof;

FIG. 5 is a right side elevational view thereof;

FIG. 6 is a top plan view thereof;

FIG. 7 is a bottom plan view thereof;

FIG. 8 is a perspective view of a second embodiment of the bottle of FIG. 1, the differences being in the shorter length of the cap closure on the figurative arm of the bottle body;

FIG. 9 is a front elevational view thereof;

FIG. 10 is a rear elevational view thereof;

FIG. 11 is a left side elevational view thereof;

FIG. 12 is a right side elevational view thereof;

FIG. 13 is a top plan view thereof; and,

FIG. 14 is a bottom plan view thereof.

**1 Claim, 8 Drawing Sheets**

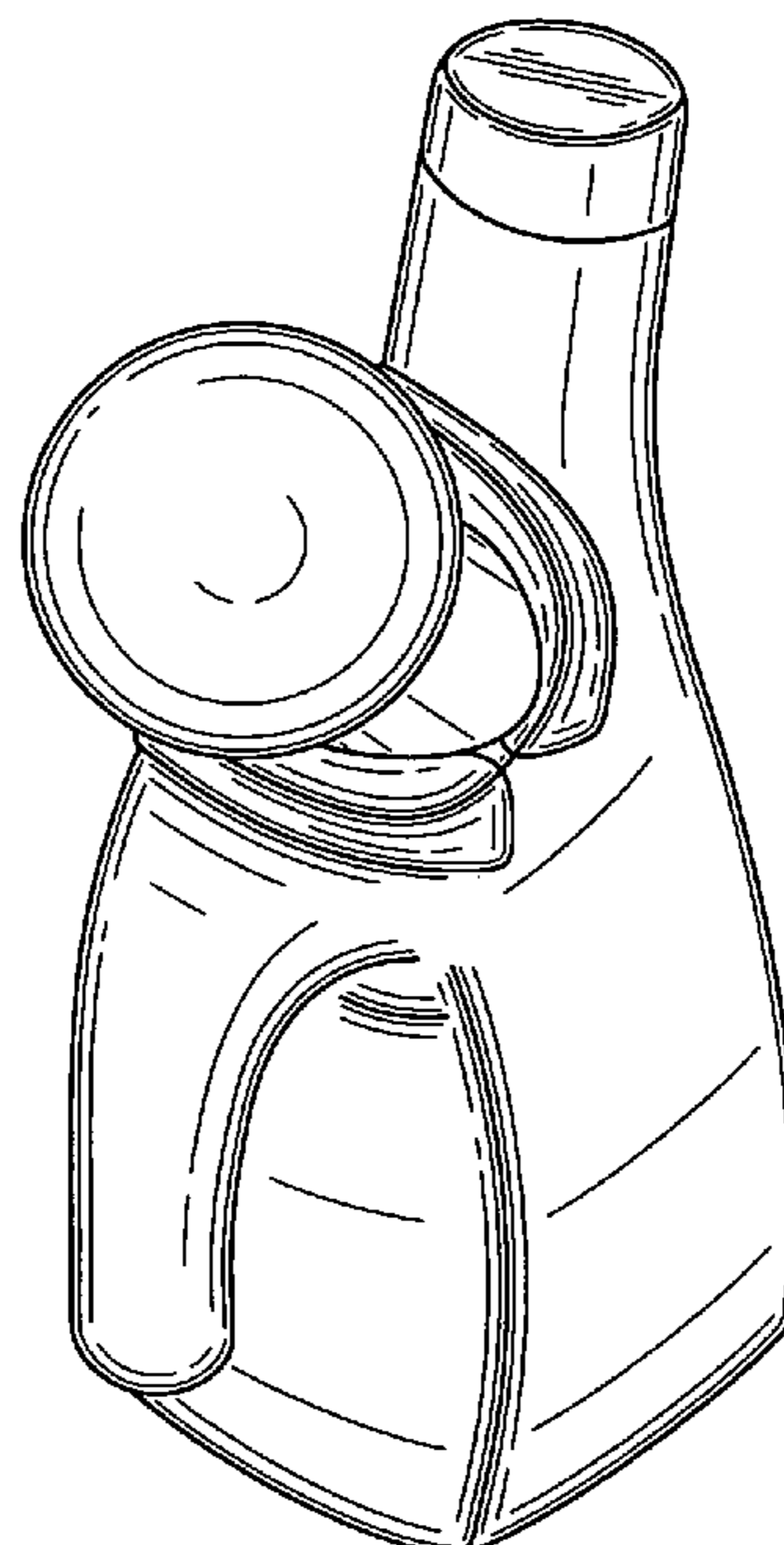
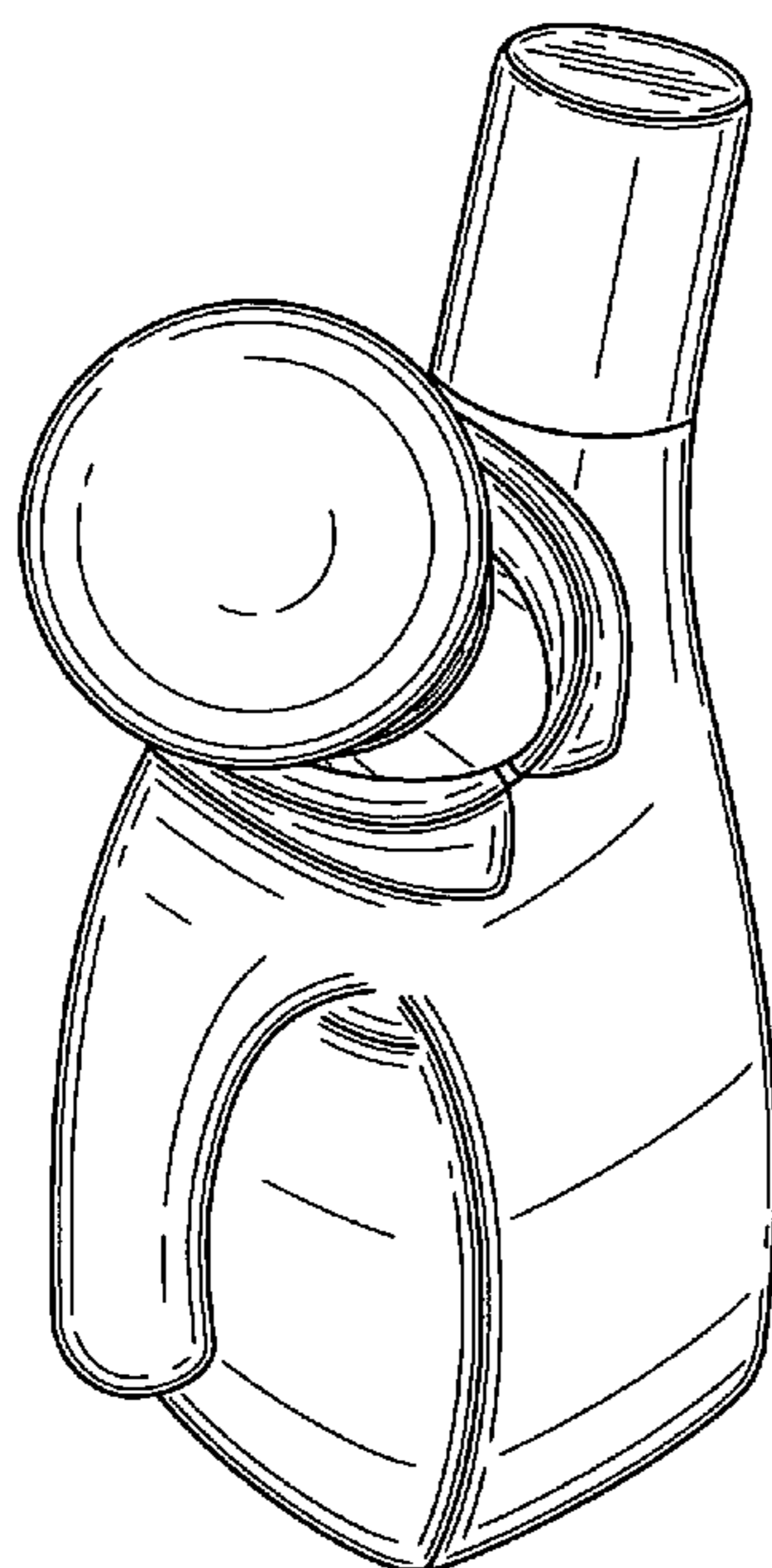

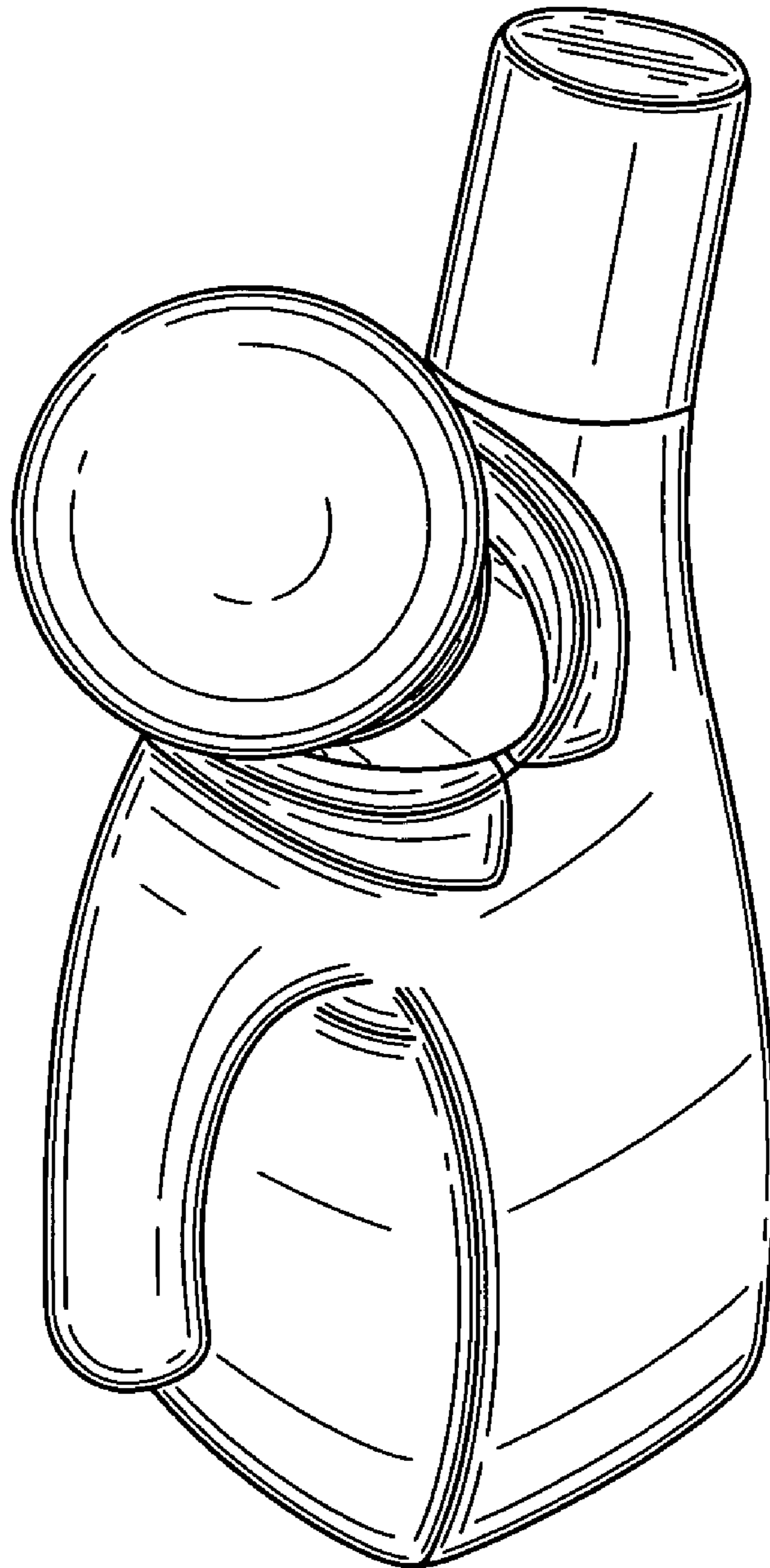

FIG. 1

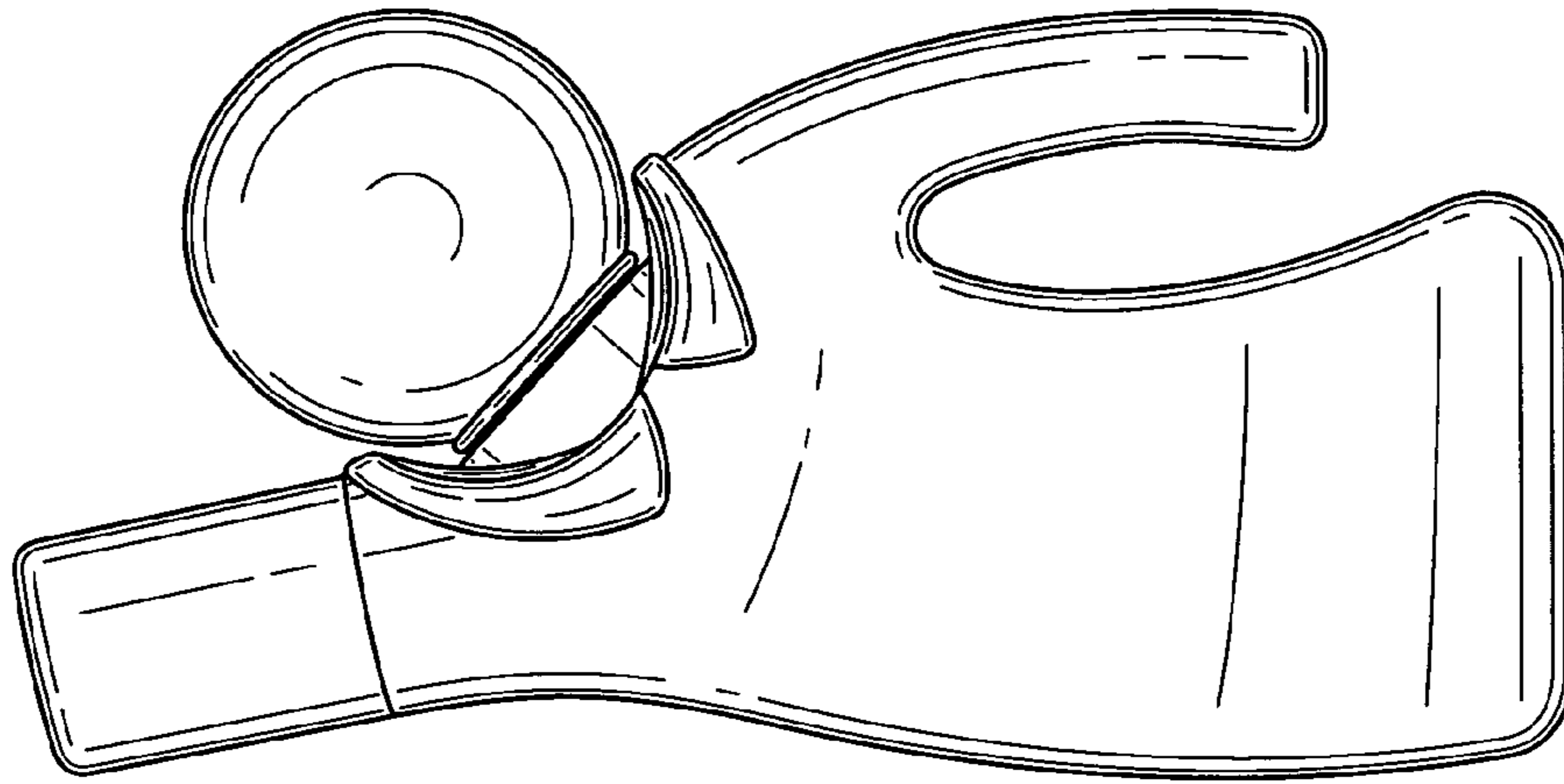

FIG. 3

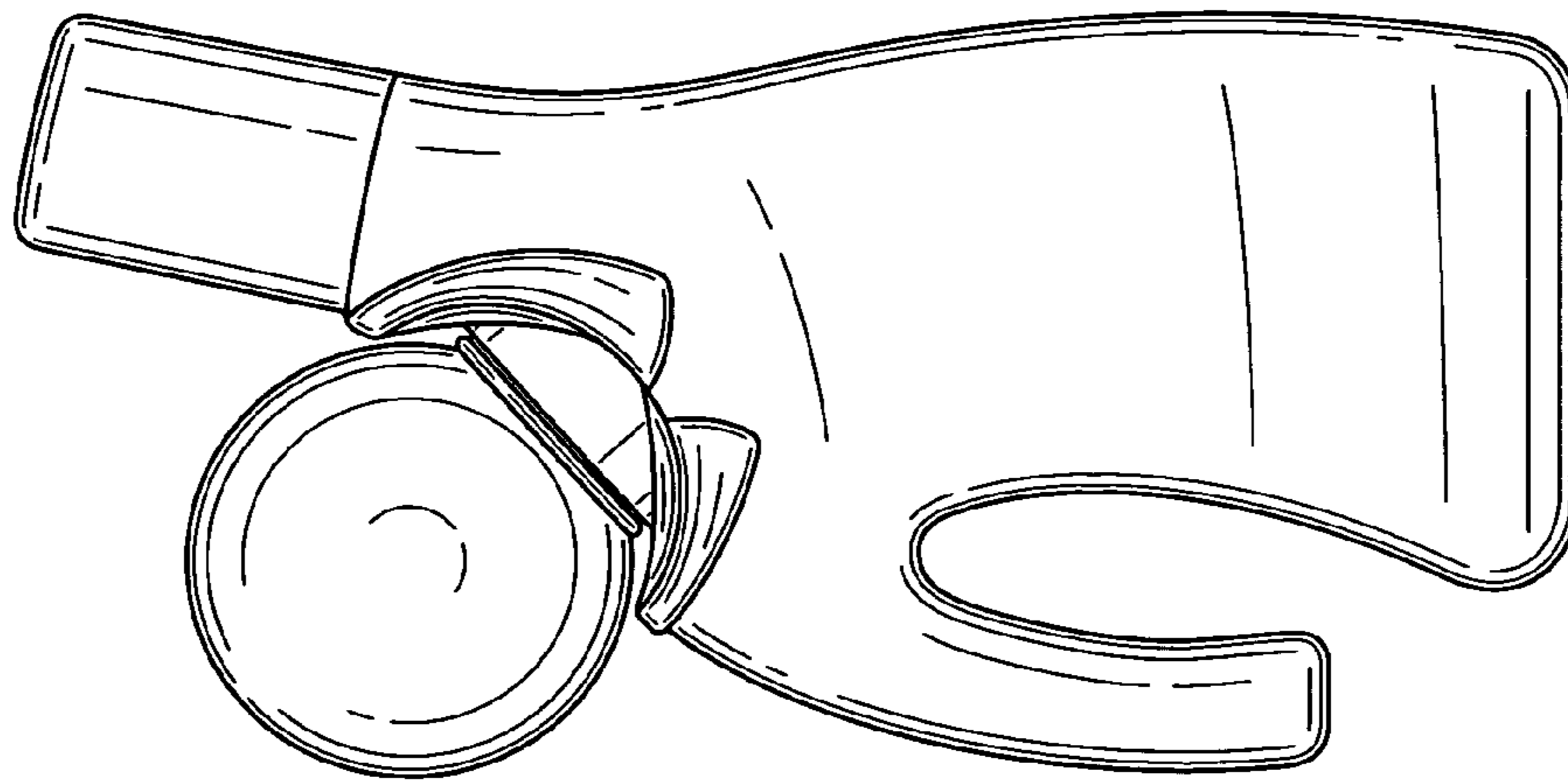

FIG. 2

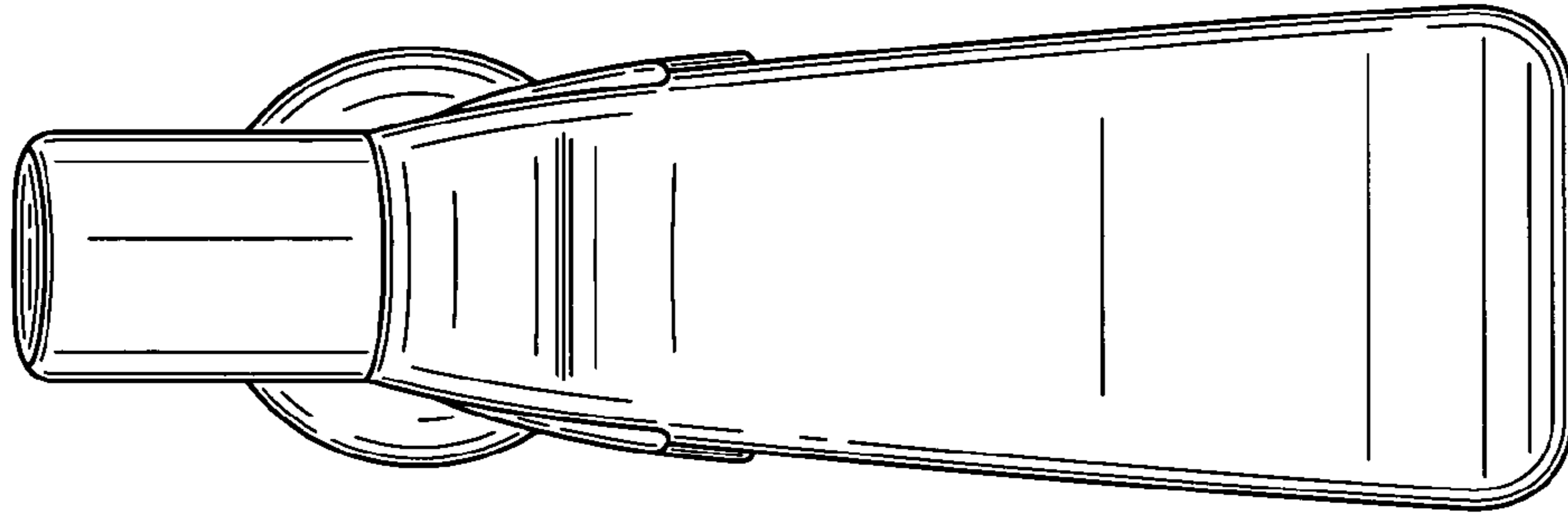

FIG. 5

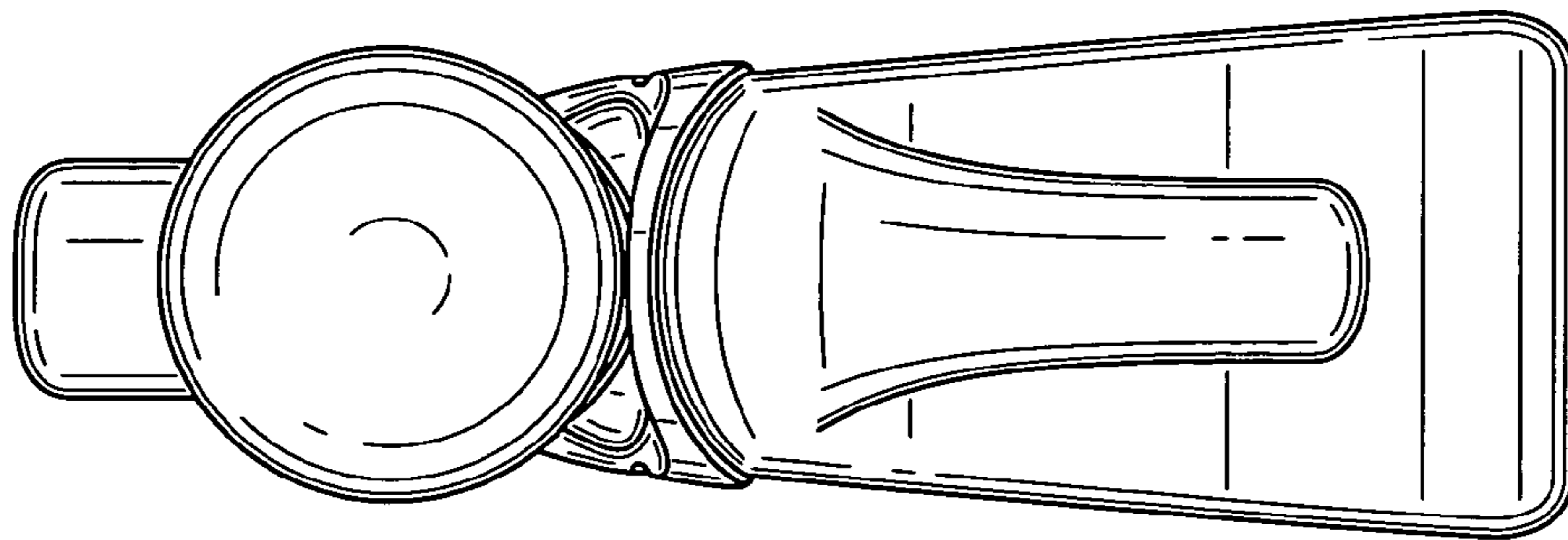

FIG. 4

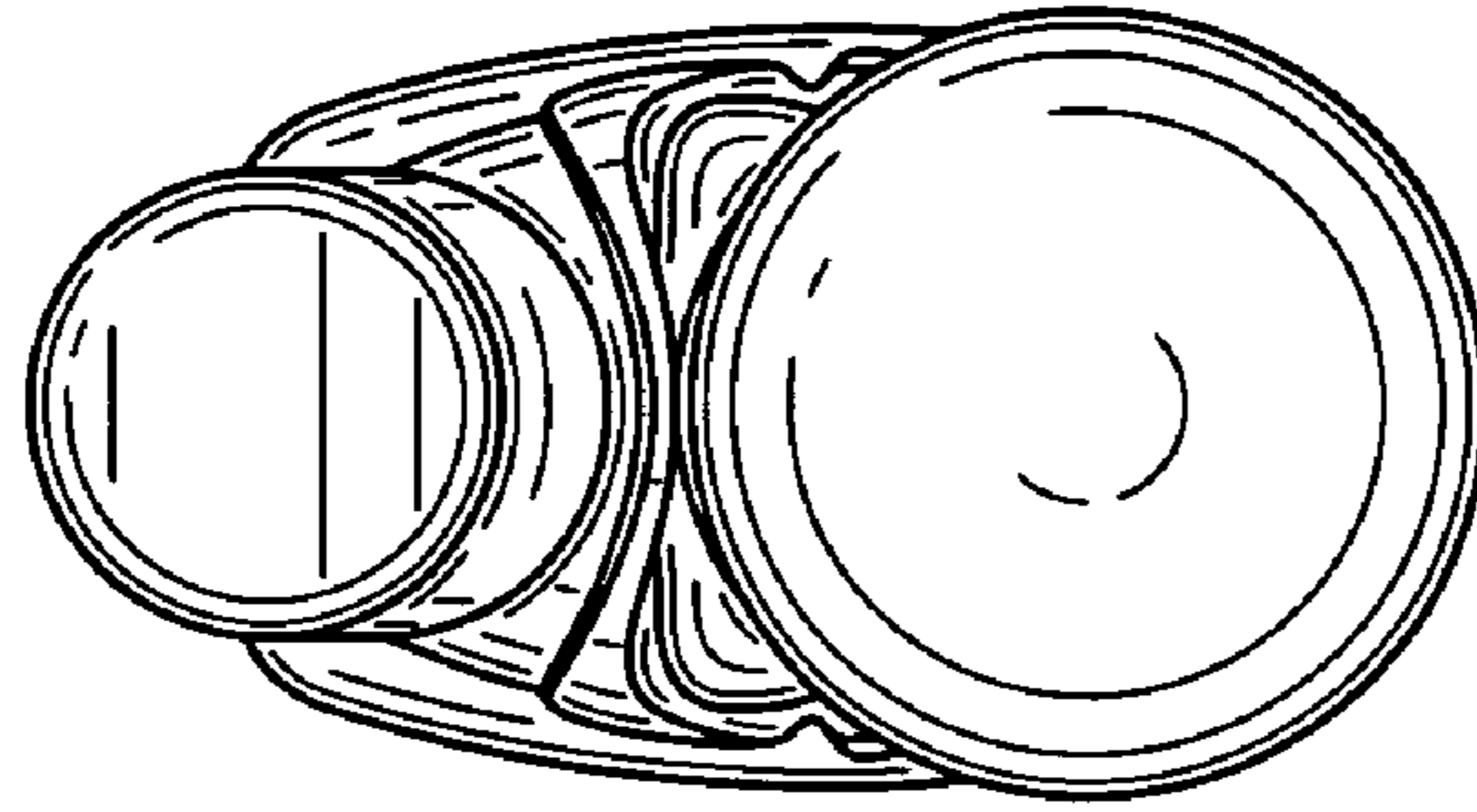

FIG. 6

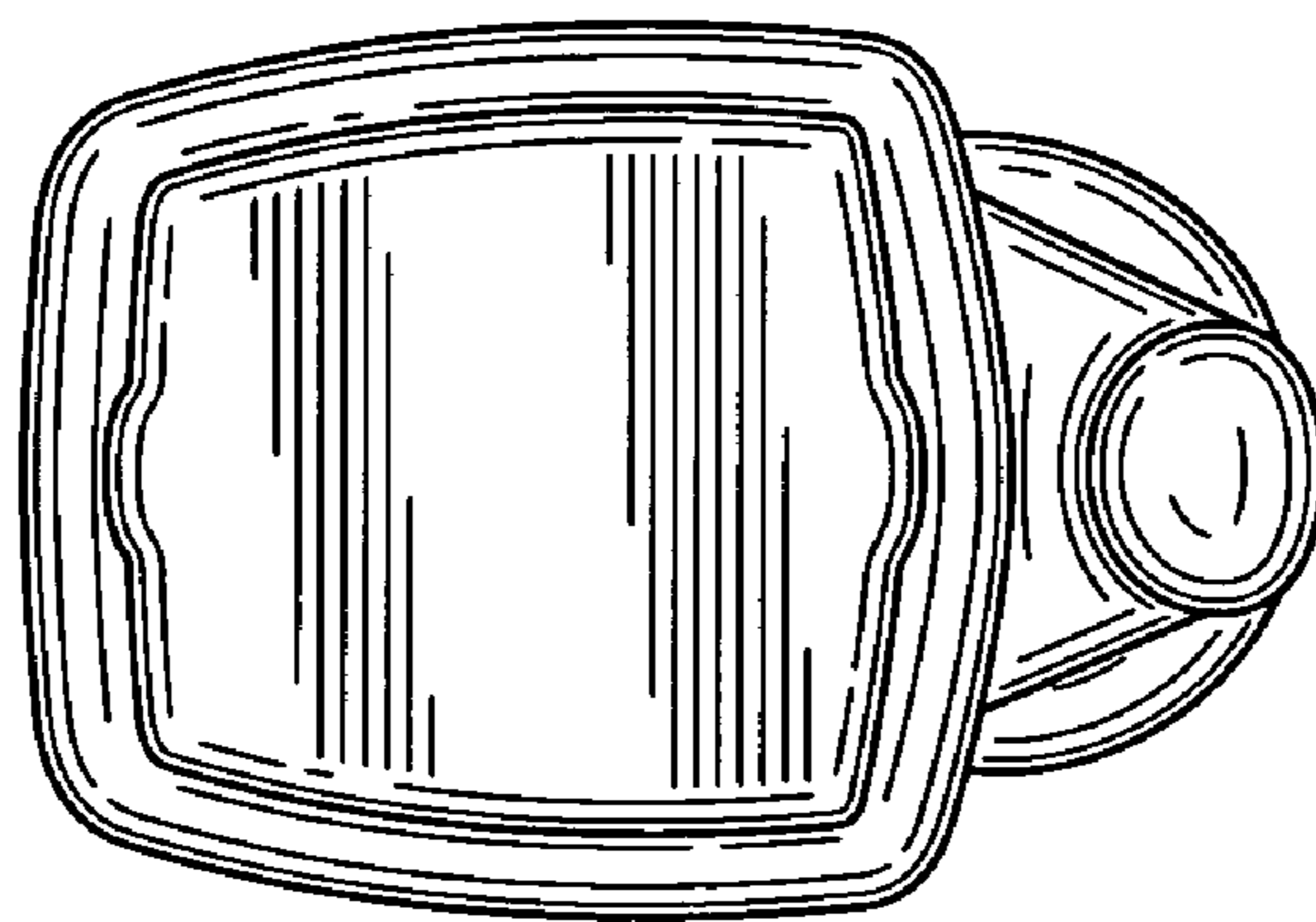

FIG. 7



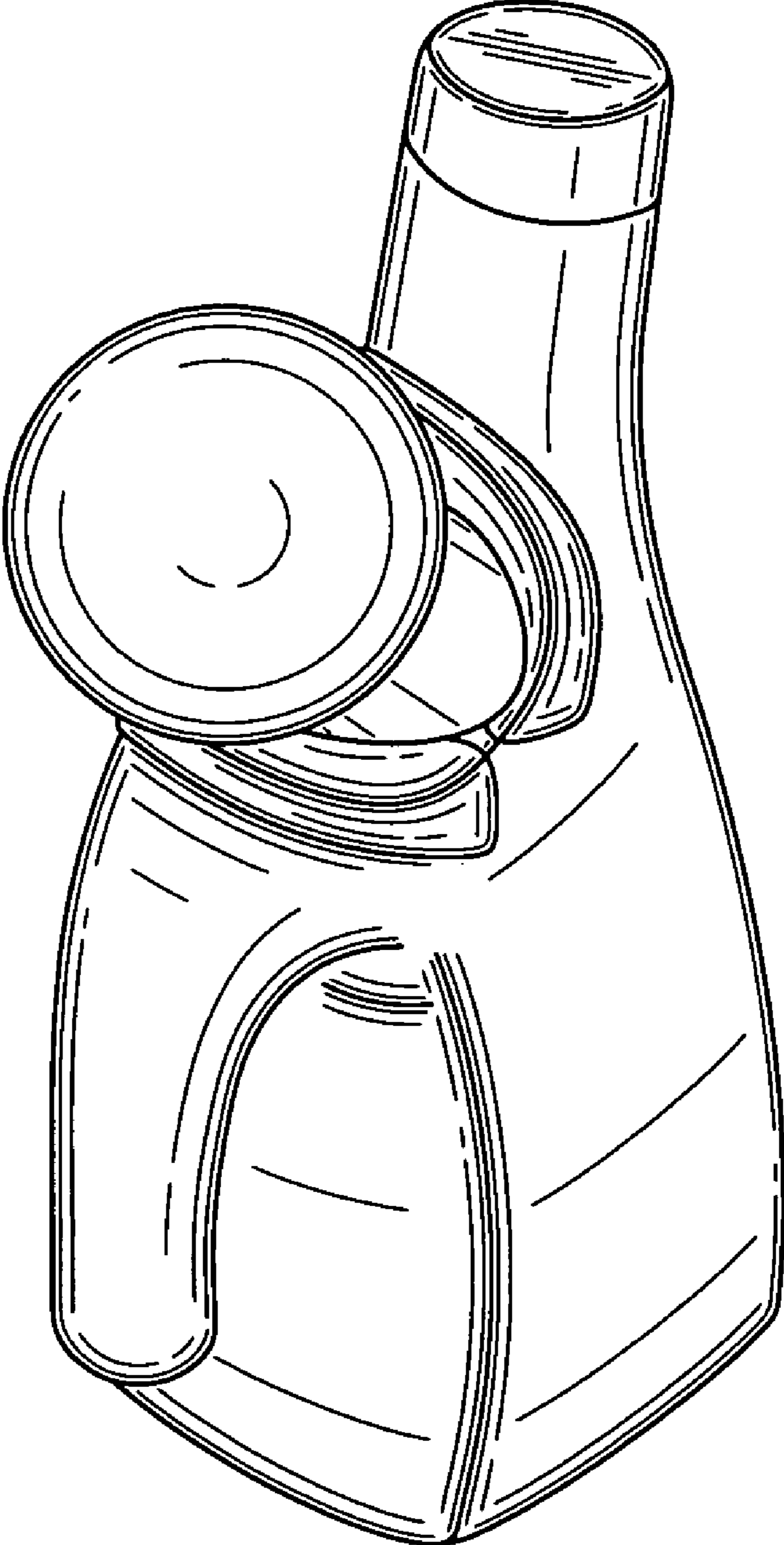

FIG. 8

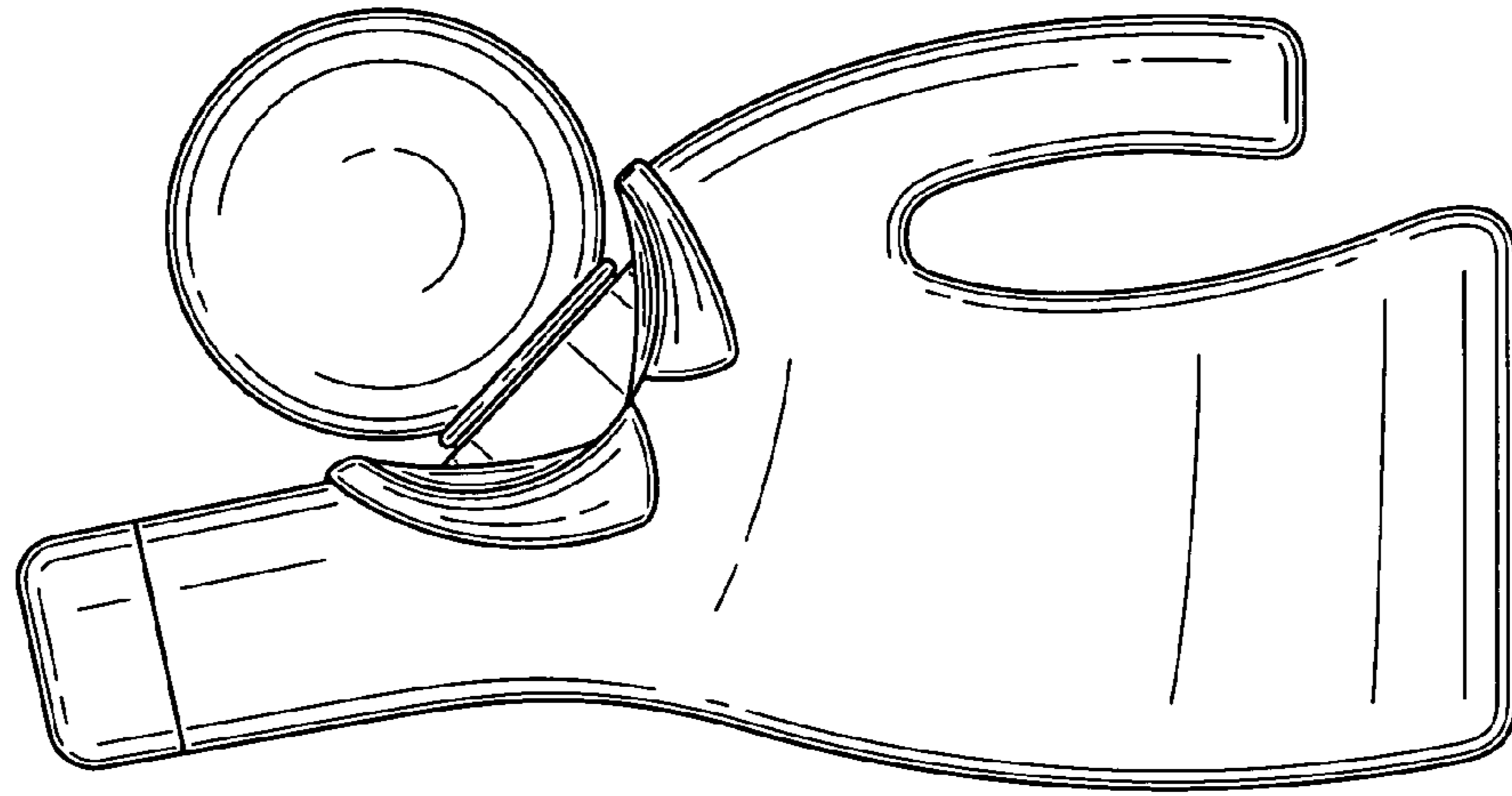

FIG. 10

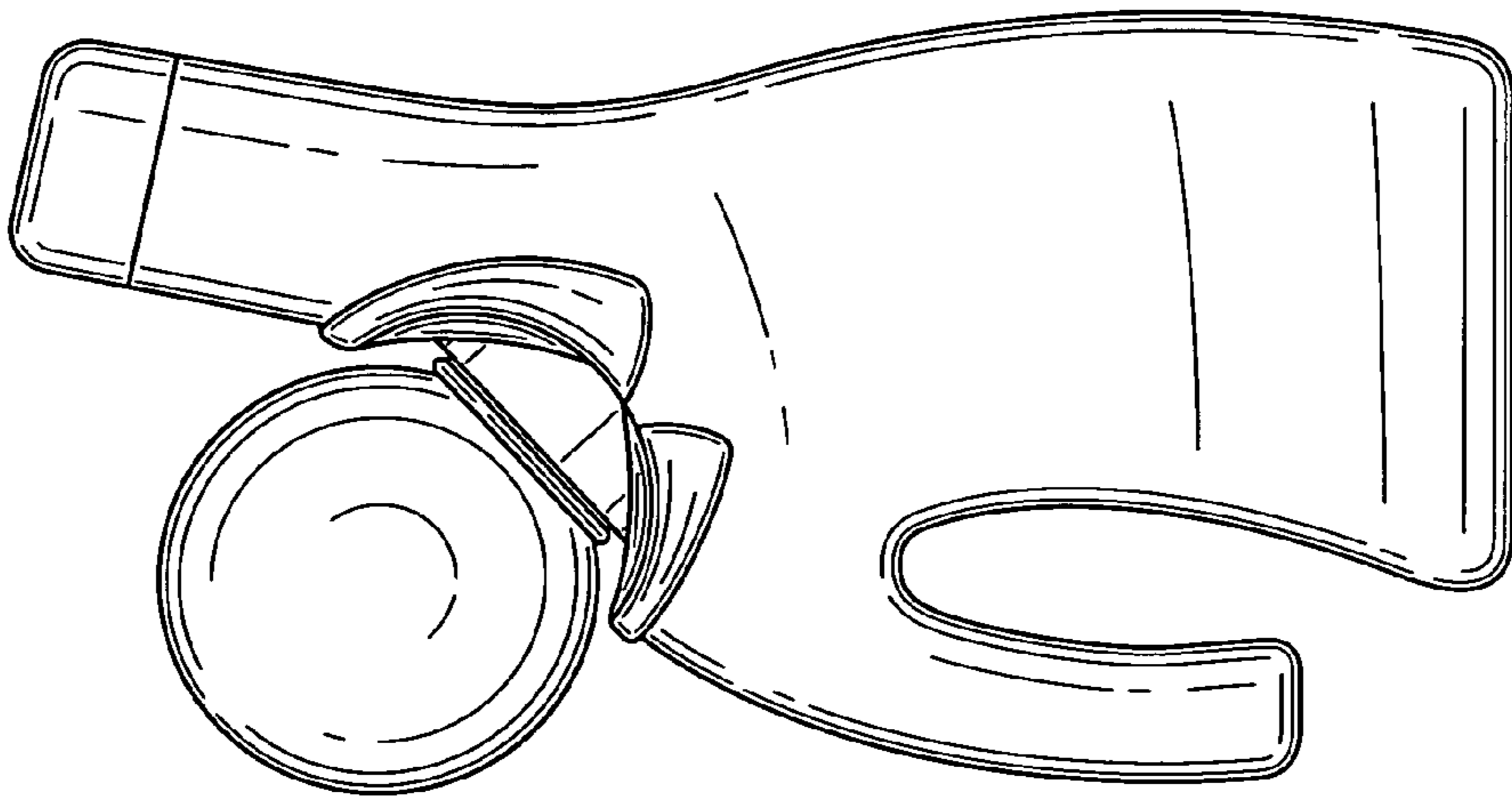

FIG. 9

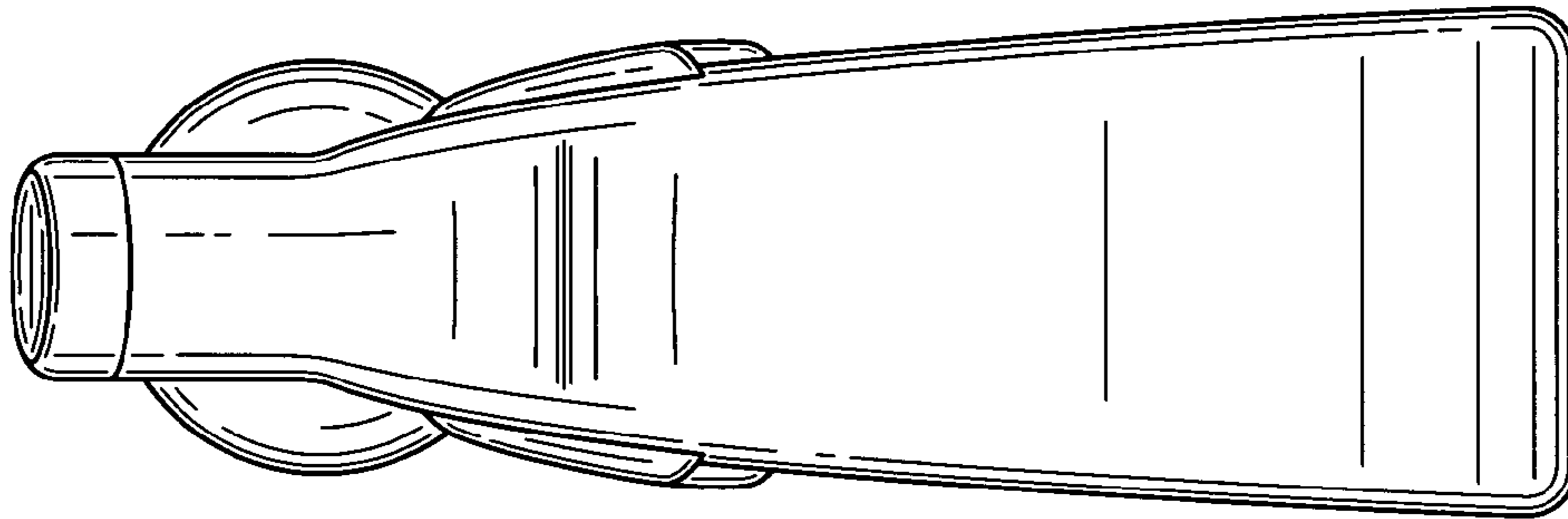

FIG. 12

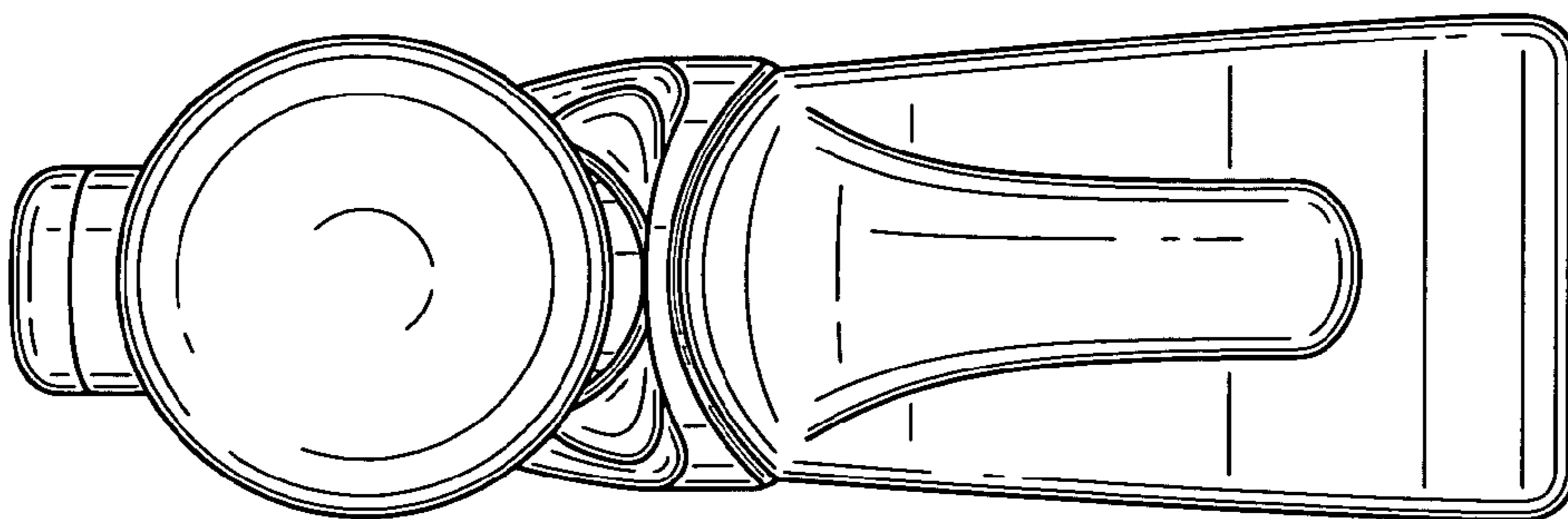

FIG. 11



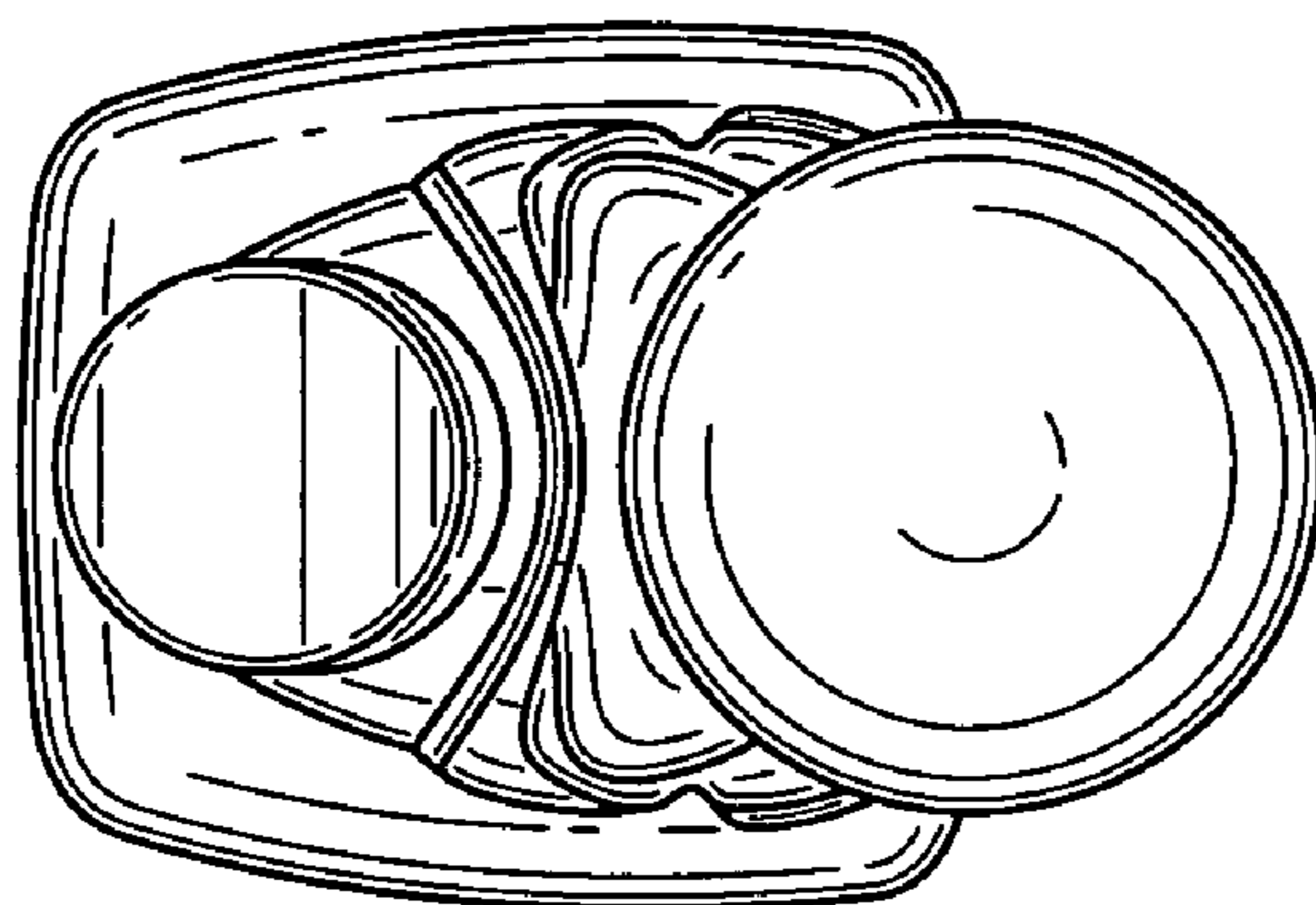

FIG. 13

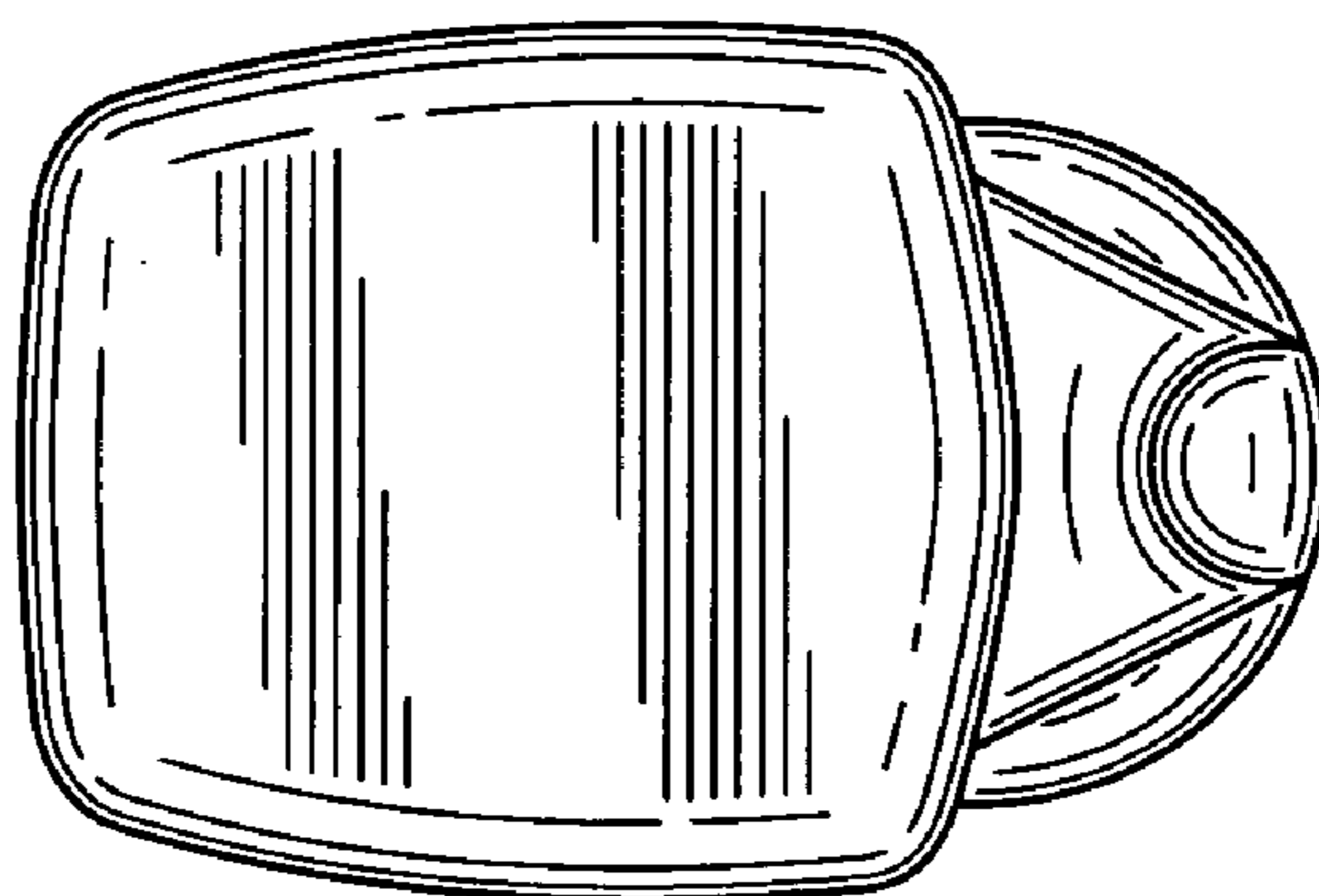

FIG. 14