

US00D562674S

(12) **United States Design Patent**  
**Shinjo**

(10) **Patent No.:** **US D562,674 S**

(45) **Date of Patent:** **\*\* Feb. 26, 2008**

(54) **CLINCH BOLT**

D455,338 S \* 4/2002 Moser ..... D8/387

(75) Inventor: **Katsumi Shinjo**, Osaka (JP)

\* cited by examiner

(73) Assignee: **Pias Sales Co., Ltd**, Osaka (JP)

*Primary Examiner*—Holly H. Baynham

*Assistant Examiner*—Sheryl Friedman

(\*\*) Term: **14 Years**

(74) *Attorney, Agent, or Firm*—Antonelli, Terry, Stout &

Kraus, LLP.

(21) Appl. No.: **29/262,172**

(57) **CLAIM**

(22) Filed: **Jun. 28, 2006**

The ornamental design for a clinch bolt, as shown and described.

(30) **Foreign Application Priority Data**

**DESCRIPTION**

Dec. 28, 2005 (JP) ..... 2005-038564

(51) **LOC (8) Cl.** ..... **08-08**

FIG. 1 is a perspective view thereof;

(52) **U.S. Cl.** ..... **D8/387**

FIG. 2 is a top plan view thereof;

(58) **Field of Classification Search** ..... D8/387,  
D8/388, 393; 411/387, 352, 353, 168, 188,  
411/378, 411, 178, 80.1

FIG. 3 is a front elevation thereof; the rear is a mirror image of the front;

See application file for complete search history.

FIG. 4 is a bottom plan view thereof;

(56) **References Cited**

FIG. 5 is a left-side elevation thereof; right side is a mirror image of the left-side,

**U.S. PATENT DOCUMENTS**

FIG. 6 is a cross section taken along the line A-A' in FIG. 4; and,

2,685,320 A \* 8/1954 Rosan ..... 411/180

FIG. 7 is a cross section taken along the line B-B' in FIG. 4.

3,384,141 A \* 5/1968 Kost ..... 411/304

4,432,680 A \* 2/1984 Molina ..... 411/103

D285,651 S \* 9/1986 Iwata et al. .... D8/387

4,854,795 A \* 8/1989 Duran ..... 411/352

**1 Claim, 2 Drawing Sheets**

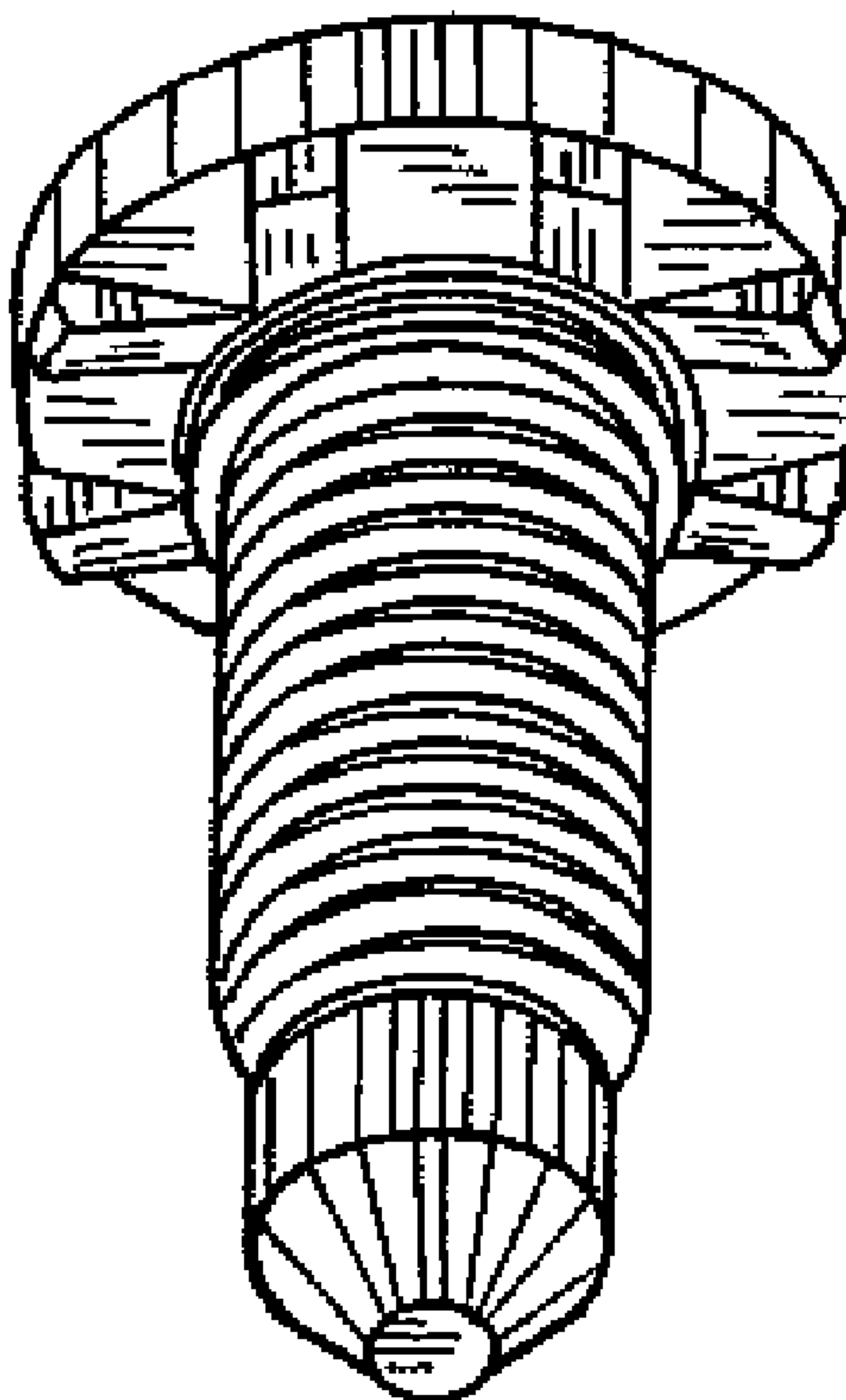

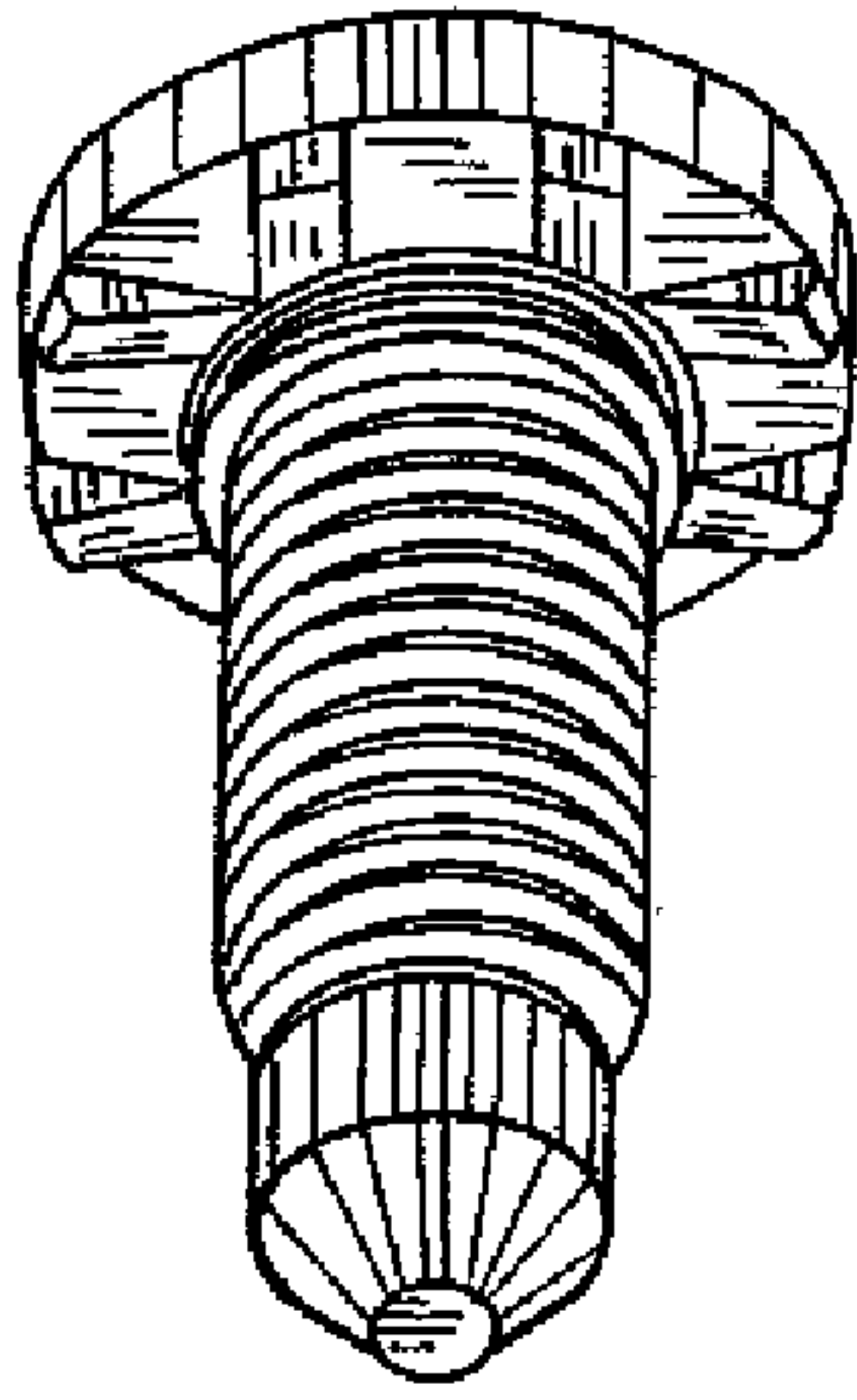

Fig. 1

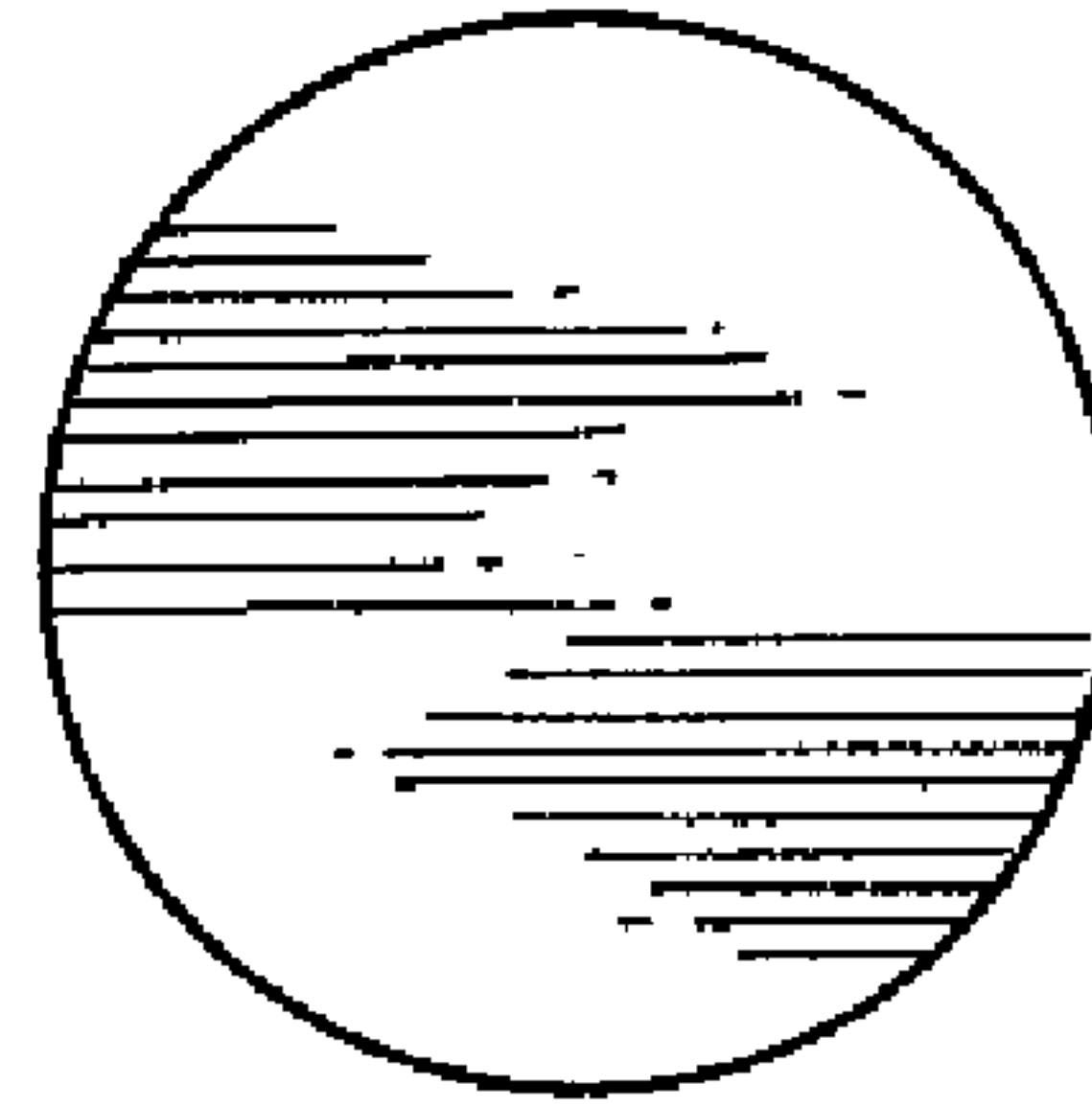

Fig. 2

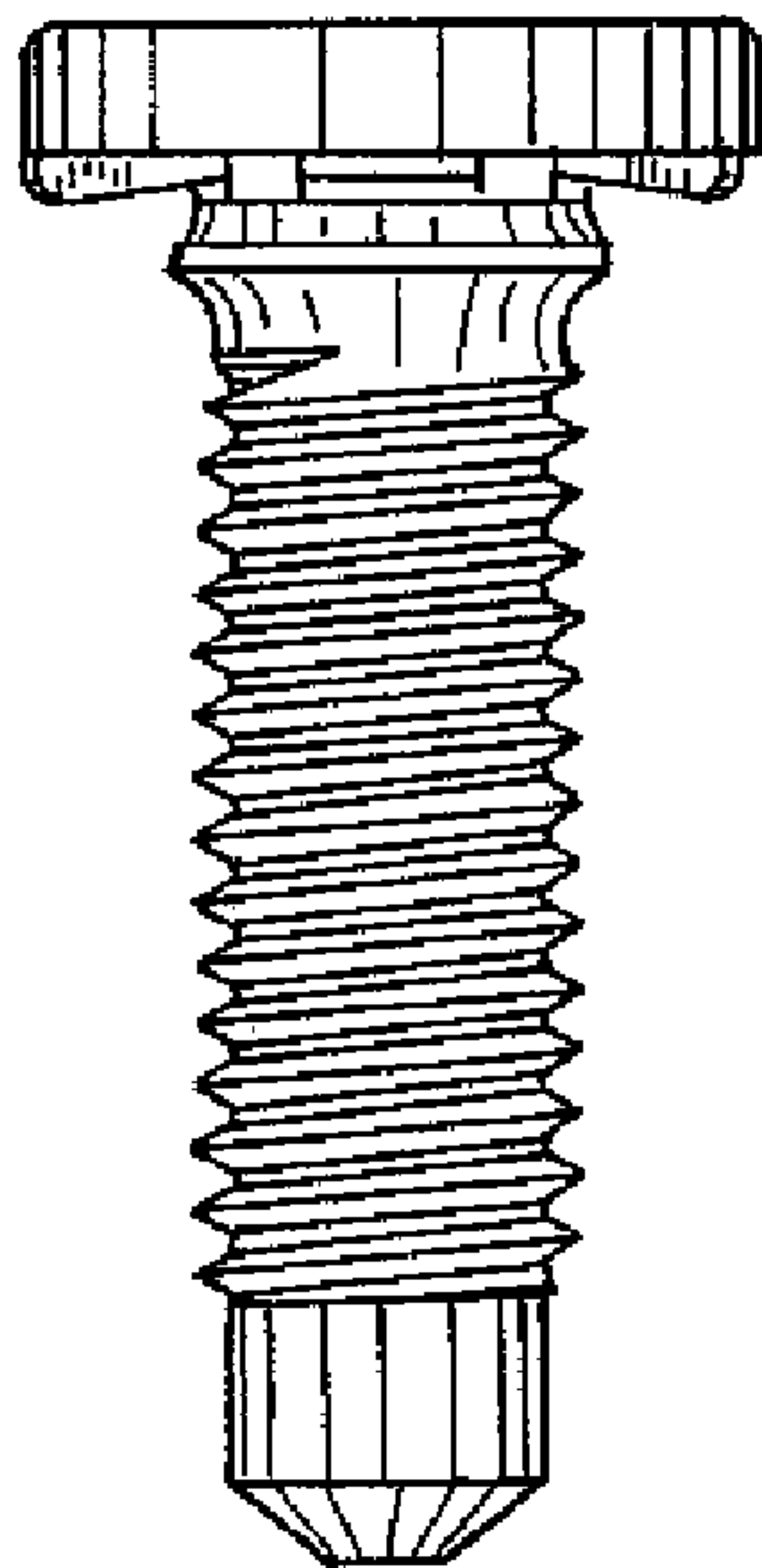

Fig. 3

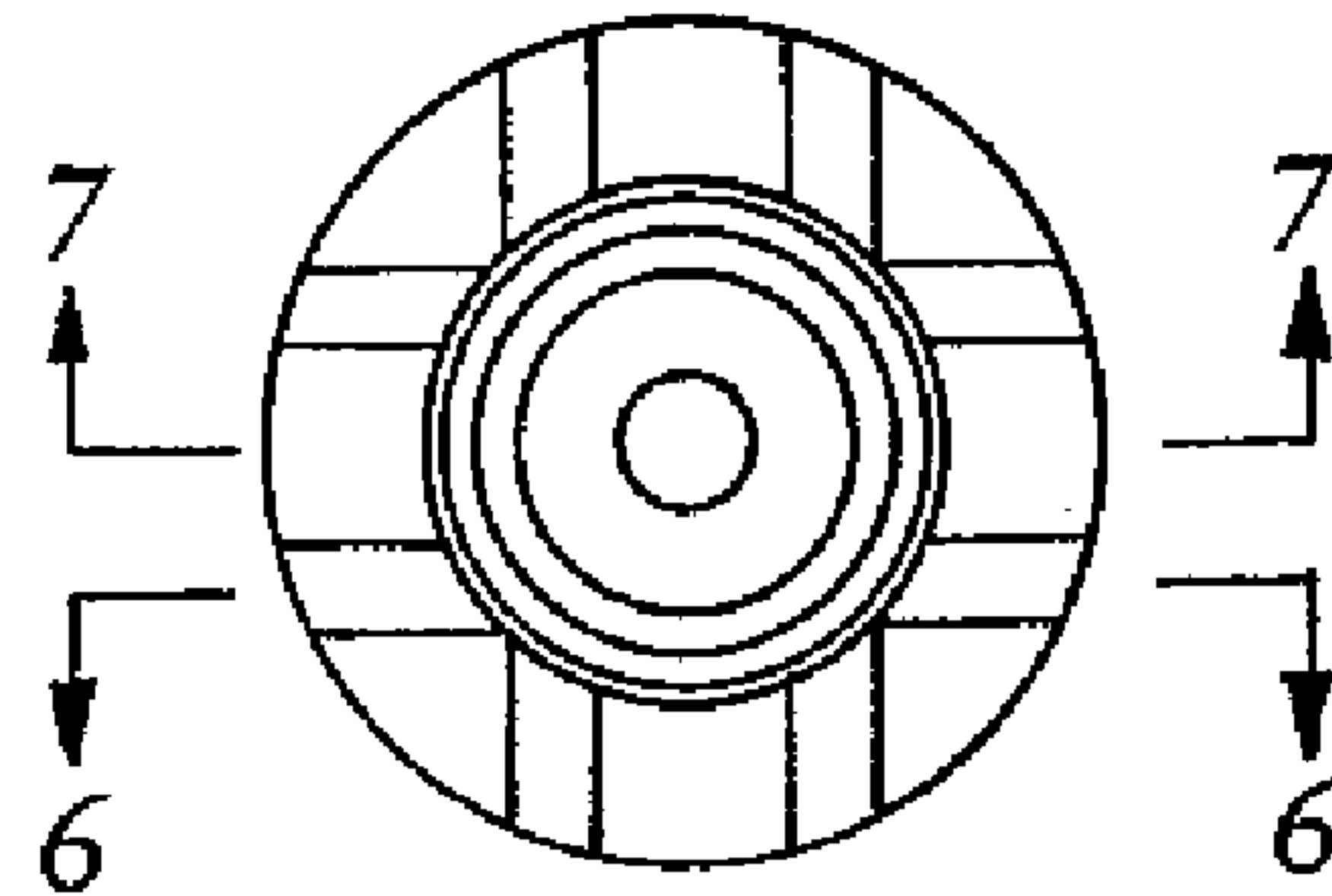

Fig. 4

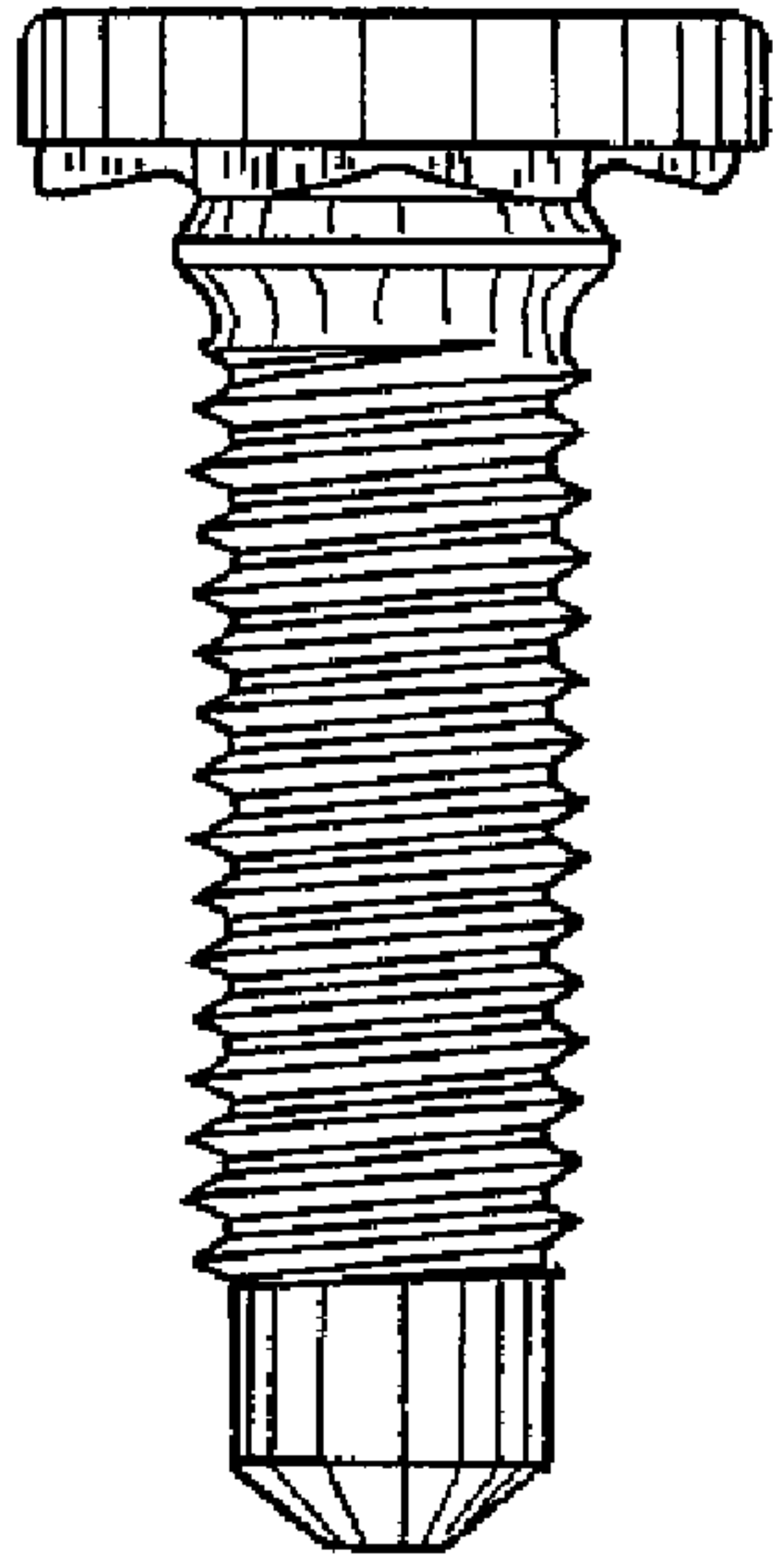

Fig. 5

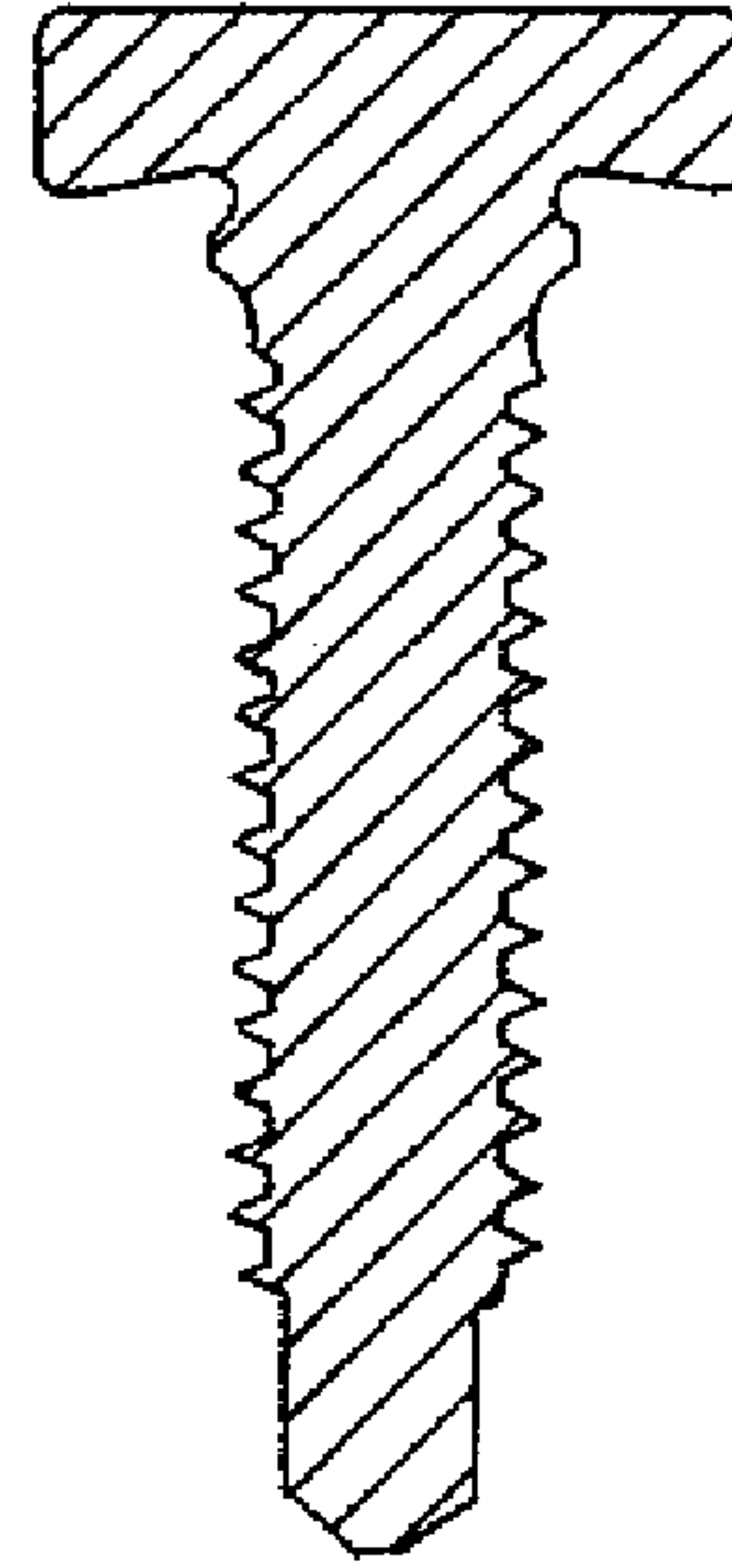

Fig. 6

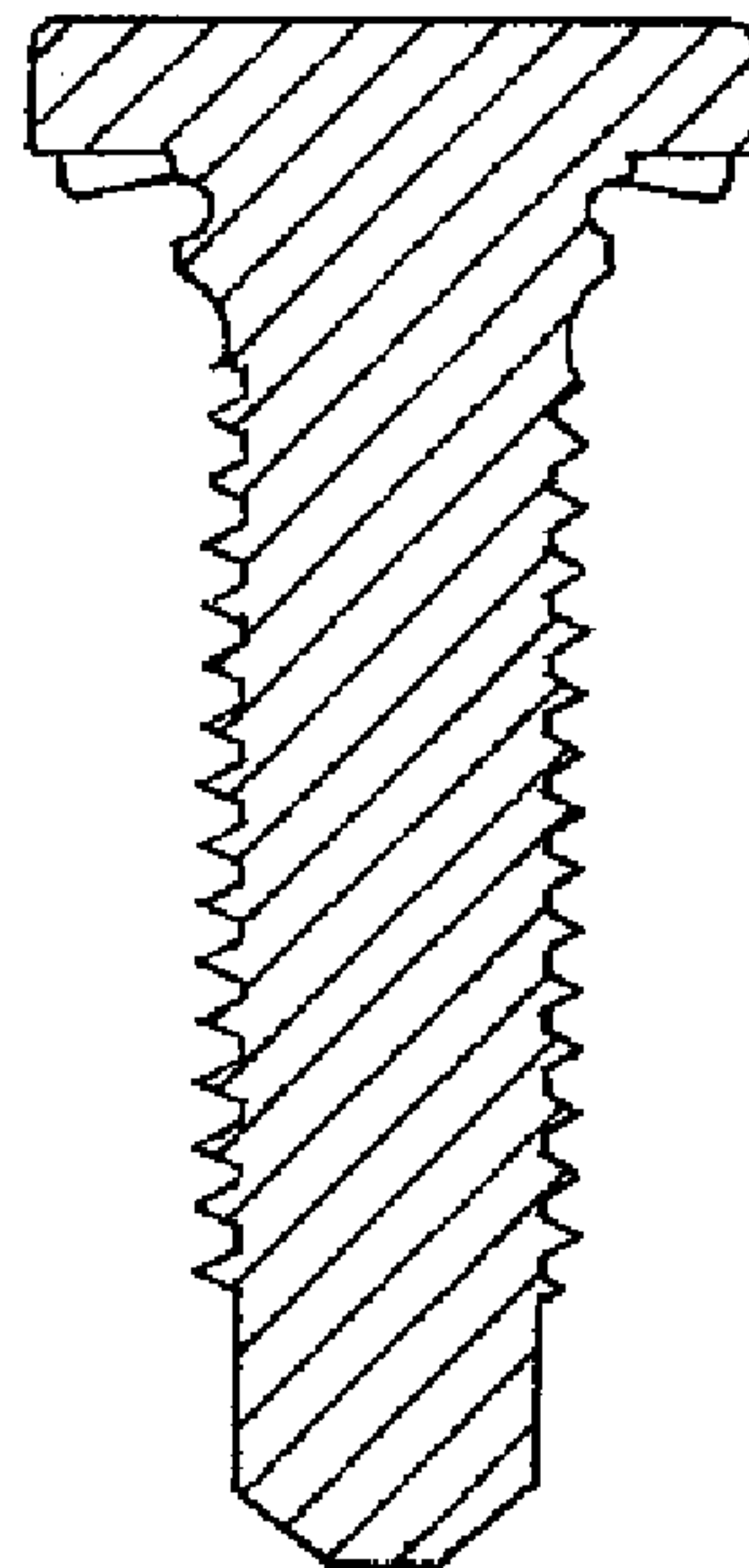

Fig. 7