



US00D562663S

(12) **United States Design Patent**
Wang

(10) **Patent No.:** **US D562,663 S**

(45) **Date of Patent:** **** Feb. 26, 2008**

(54) **ELECTRIC DRILL**

(76) Inventor: **Min-Hsieng Wang**, P.O. Box 90,
Tainan City (TW) 70499

(**) Term: **14 Years**

(21) Appl. No.: **29/273,538**

(22) Filed: **Mar. 8, 2007**

(51) **LOC (8) Cl.** **08-01**

(52) **U.S. Cl.** **D8/68**

(58) **Field of Classification Search** D8/14.1,
D8/61-70; 81/57.11, 429, 454-456, 469,
81/489; 173/13, 104, 114, 168-171, 178,
173/201, 211, 213, 217; 408/20, 124, 125,
408/234, 241 R; 451/358; 310/50; 227/8,
227/113, 114, 120, 130, 136, 142

See application file for complete search history.

(56) **References Cited**

U.S. PATENT DOCUMENTS

D392,863 S *	3/1998	Sugimoto et al.	D8/68
D462,594 S *	9/2002	Flickinger	D8/68
D477,205 S *	7/2003	Sakai et al.	D8/68
D484,385 S *	12/2003	Sakai et al.	D8/68
D494,435 S *	8/2004	Hayakawa et al.	D8/68
D499,945 S *	12/2004	Sugawara et al.	D8/68
D503,879 S *	4/2005	Watson	D8/68
6,883,621 B1 *	4/2005	Lin	173/217
D505,055 S *	5/2005	Nagasaka et al.	D8/68
D508,642 S *	8/2005	Kokawa et al.	D8/68
D512,891 S *	12/2005	Aglassinger	D8/68
D514,910 S *	2/2006	Nagasaka et al.	D8/68
D515,375 S *	2/2006	Tsang et al.	D8/68
D519,808 S *	5/2006	Otsuka et al.	D8/68

D525,099 S *	7/2006	Nagasaka et al.	D8/68
D525,100 S *	7/2006	Huang et al.	D8/68
D533,422 S *	12/2006	Ino et al.	D8/68
D533,423 S *	12/2006	Ino et al.	D8/68
7,186,117 B2 *	3/2007	Chen	173/217
2002/0122707 A1 *	9/2002	Sakai et al.	408/241 R
2003/0159843 A1 *	8/2003	Sakai et al.	173/217
2005/0121209 A1 *	6/2005	Shimizu et al.	173/217
2005/0155778 A1 *	7/2005	Ishida et al.	173/170
2006/0113100 A1 *	6/2006	Hsu et al.	173/217
2006/0175069 A1 *	8/2006	Sakakibara et al.	173/217
2007/0056760 A1 *	3/2007	Yoshimizu et al.	173/217

FOREIGN PATENT DOCUMENTS

GB 3003854 S * 5/2002

* cited by examiner

Primary Examiner—T. Chase Nelson

(57) **CLAIM**

The ornamental design for an electric drill, as shown and described.

DESCRIPTION

FIG. 1 is a perspective view of an electric drill showing my design;

FIG. 2 is a front elevational view thereof;

FIG. 3 is a rear elevational view thereof;

FIG. 4 is a left side elevational view thereof;

FIG. 5 is a right side elevational view thereof;

FIG. 6 is a top plan view thereof; and,

FIG. 7 is a bottom plan view thereof.

1 Claim, 7 Drawing Sheets

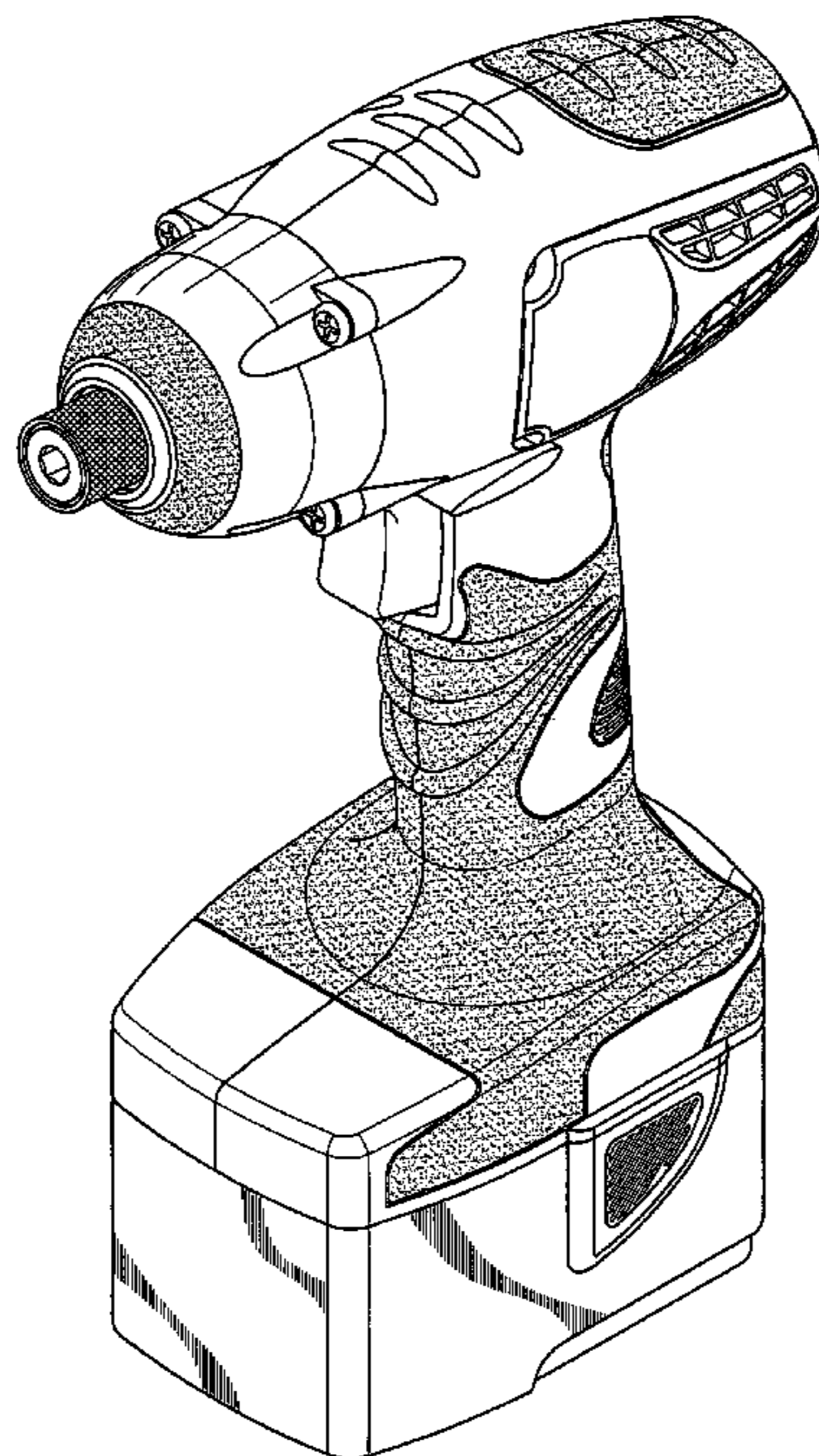

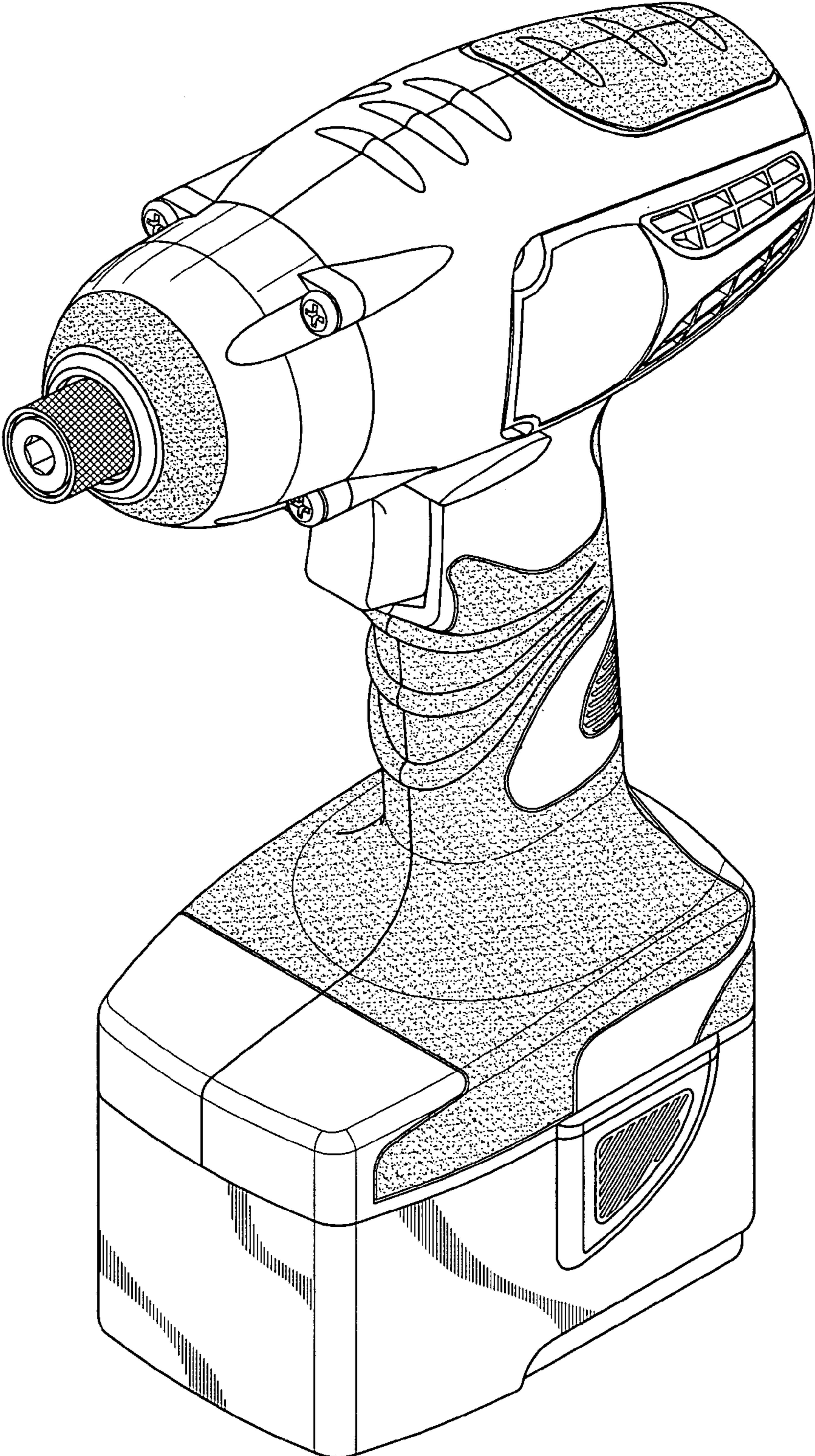

FIG.1

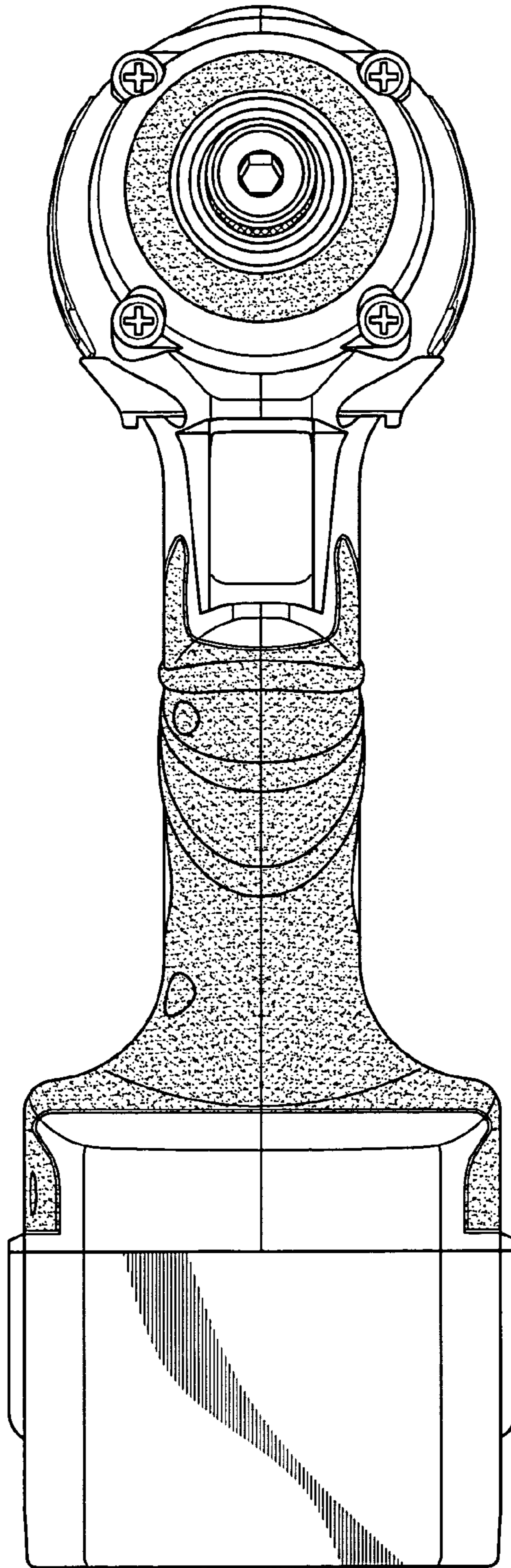

FIG. 2

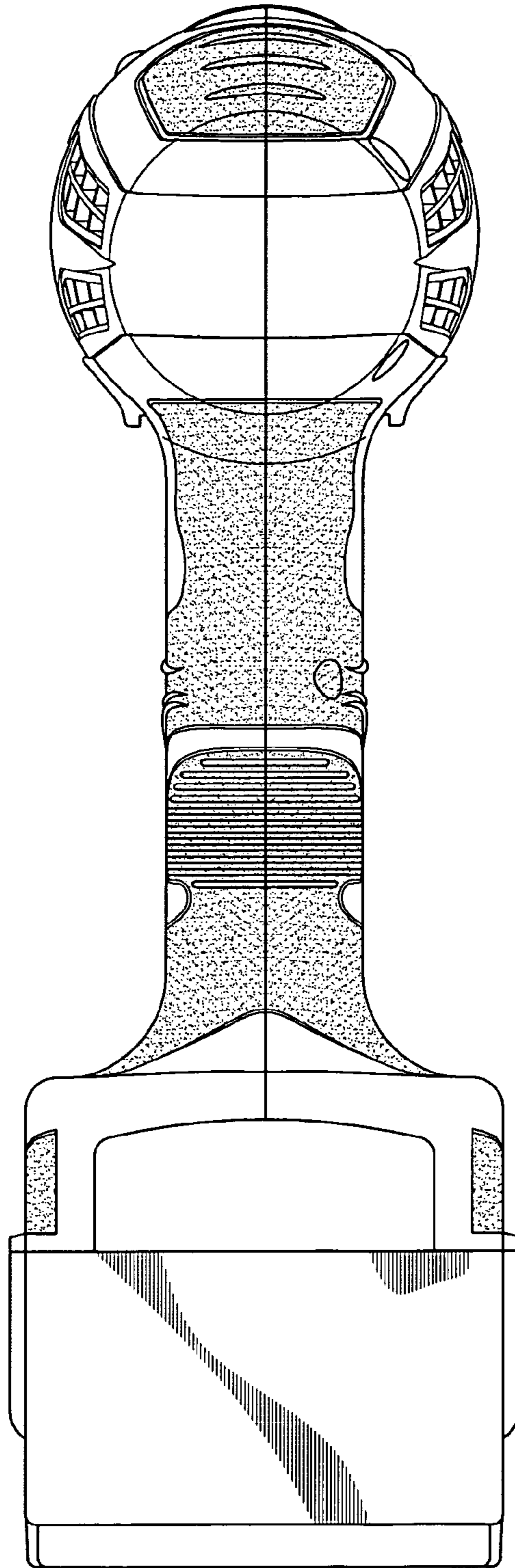

FIG. 3

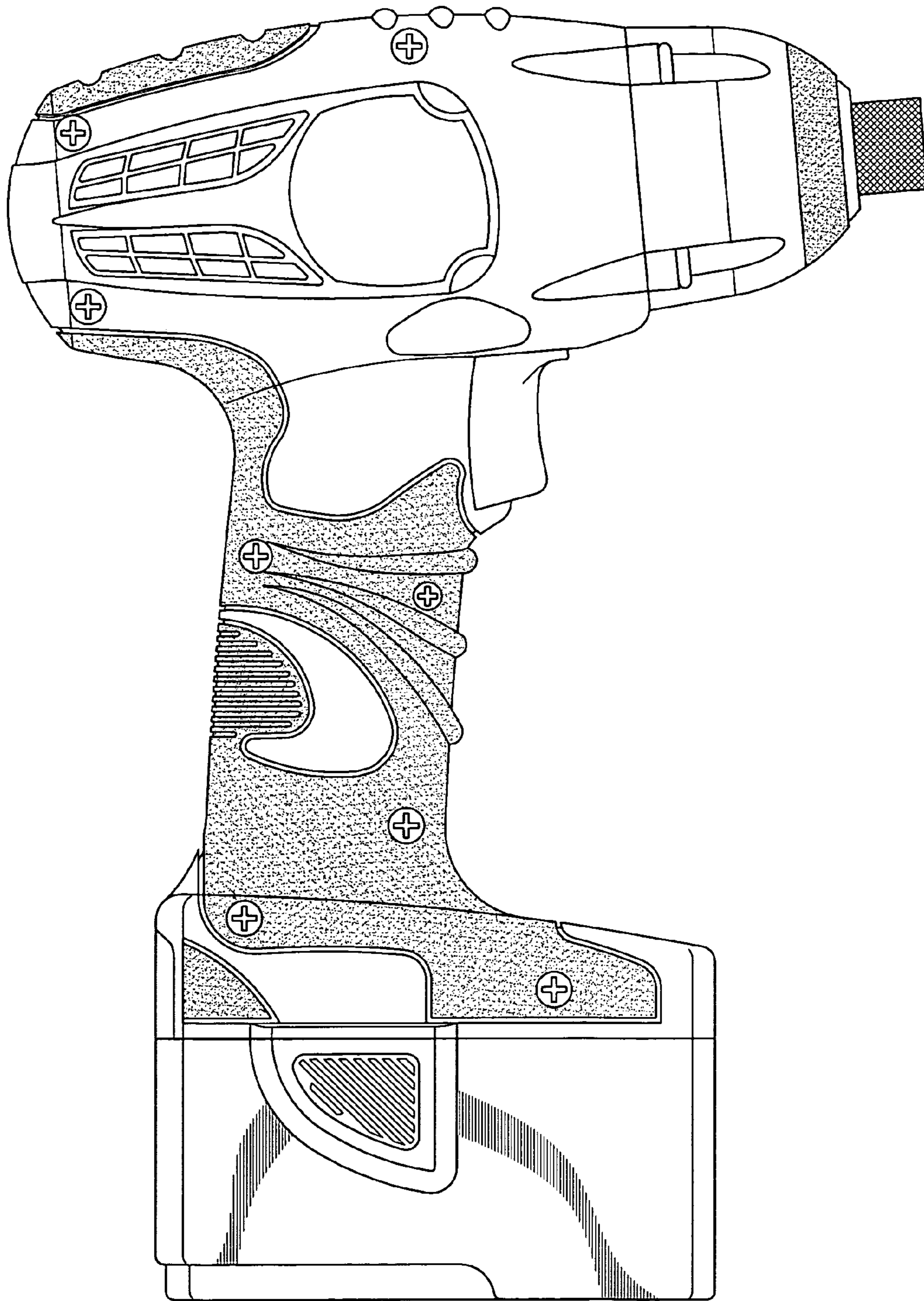

FIG.4

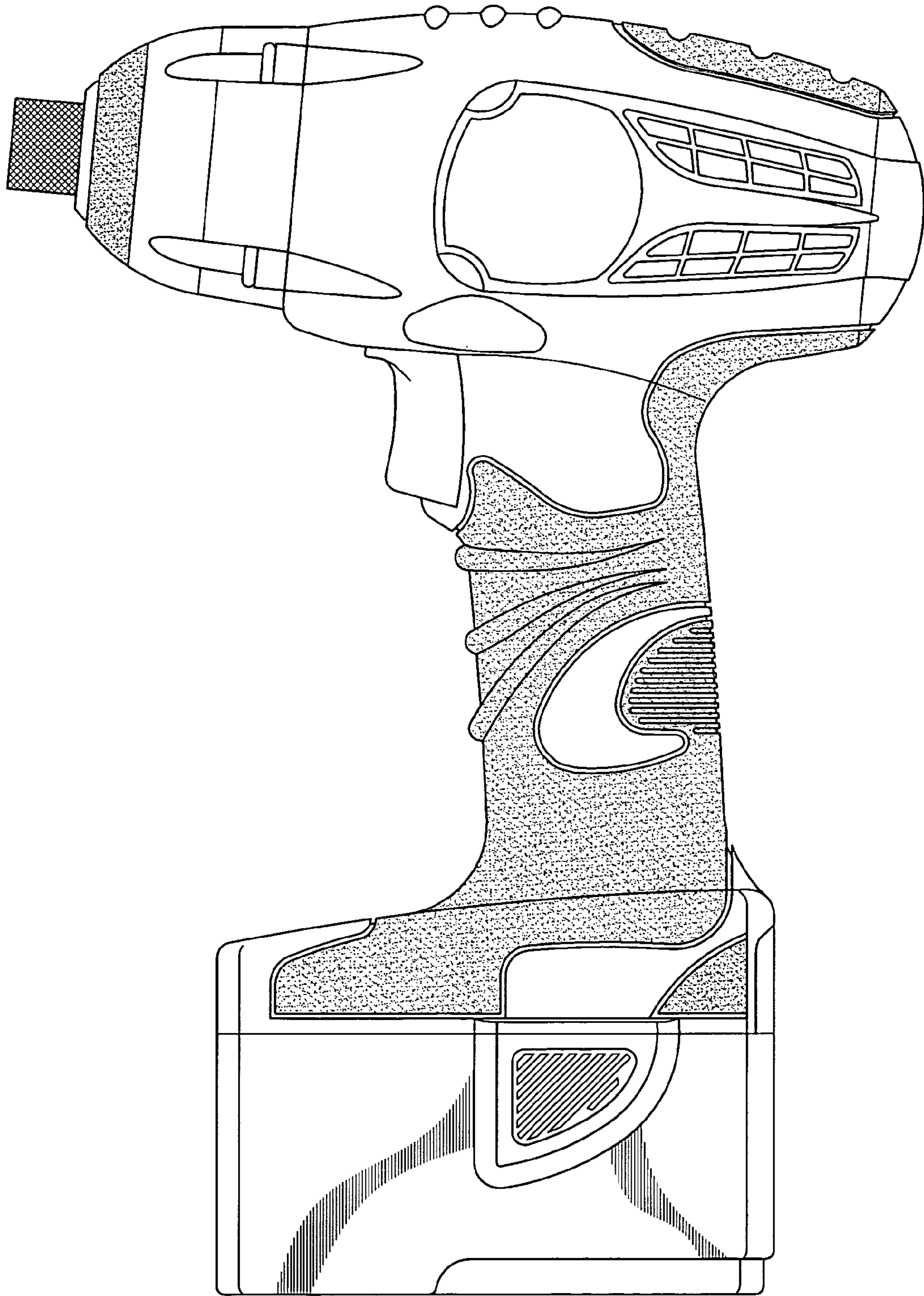

FIG.5

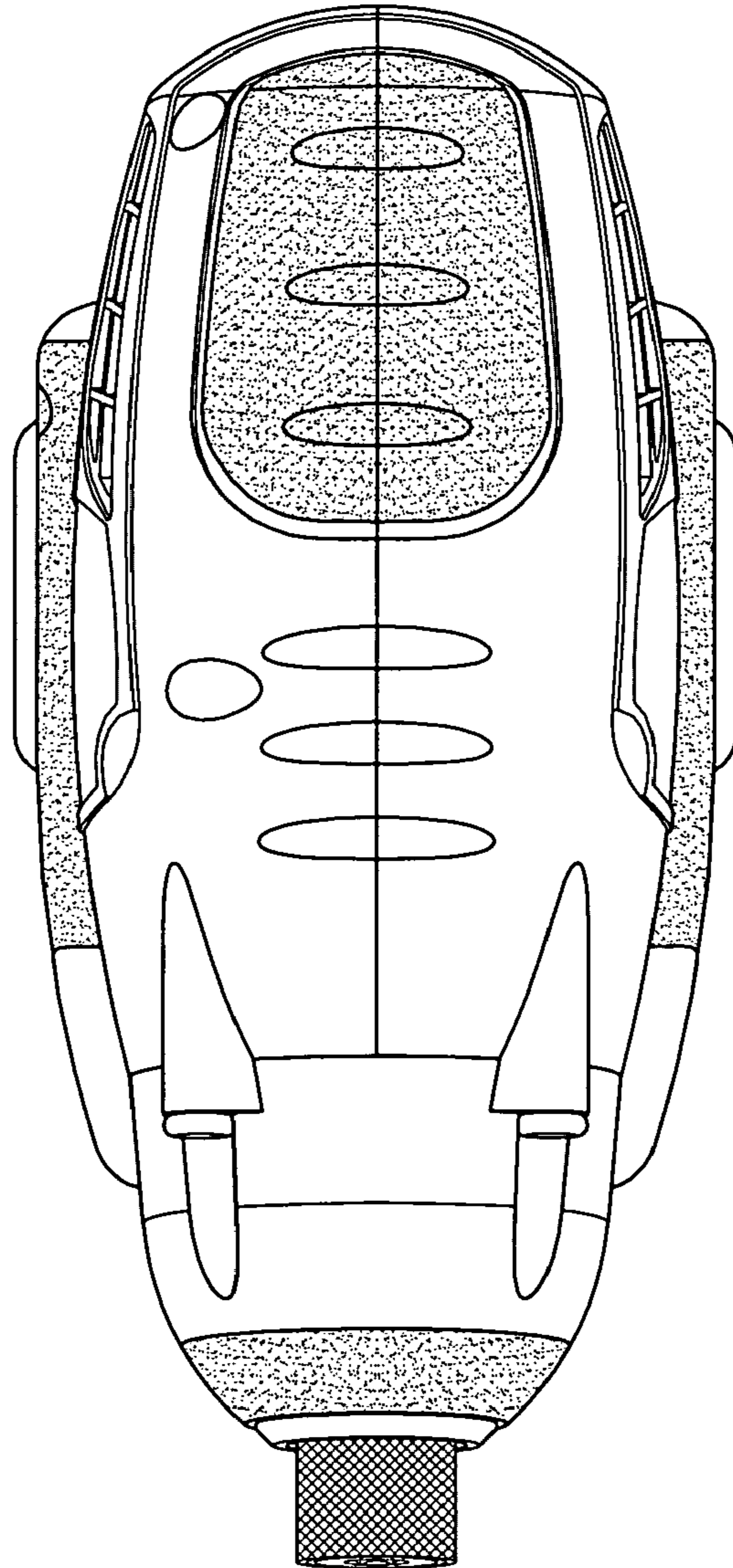

FIG.6

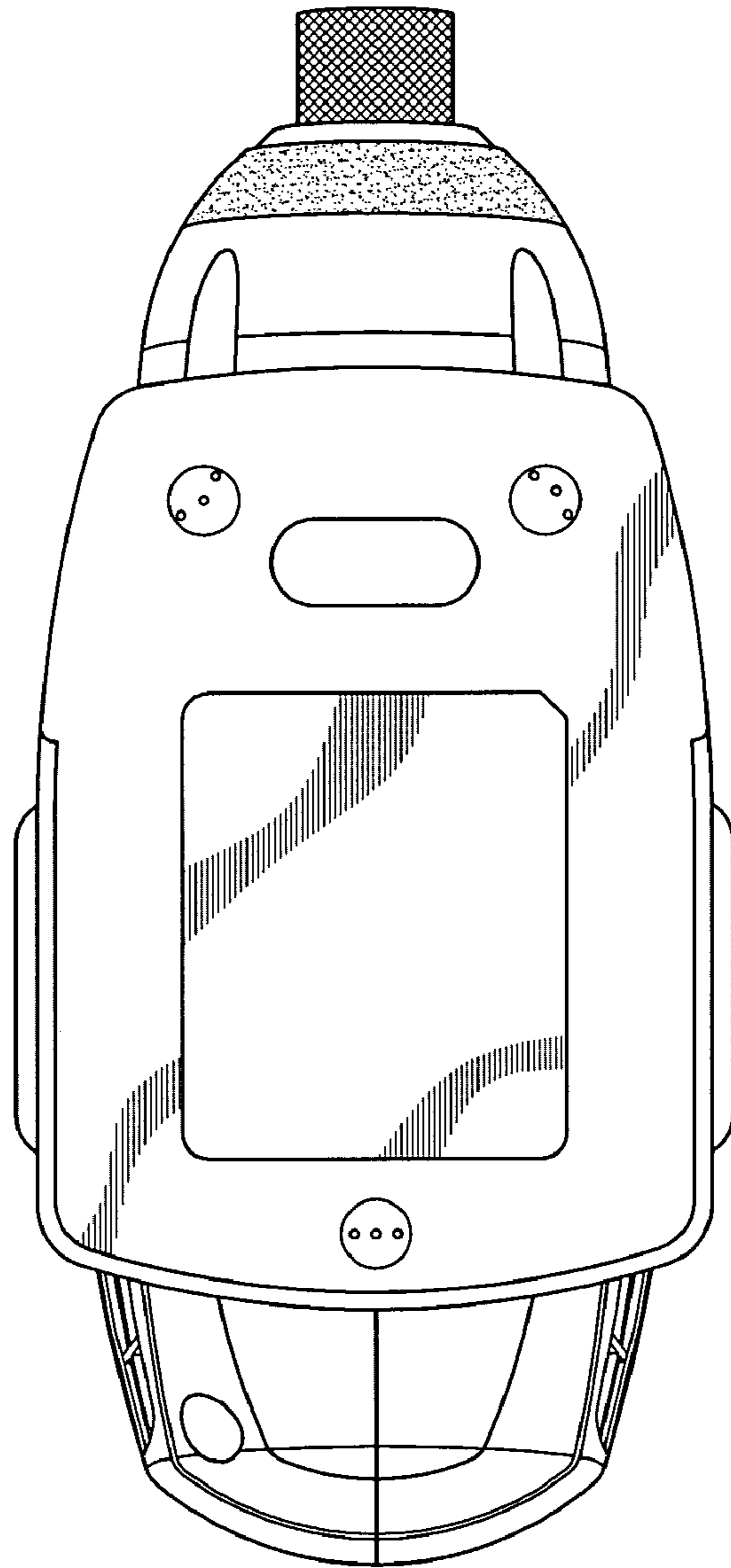

FIG.7