

US00D562511S

(12) **United States Design Patent**
Medema et al.

(10) **Patent No.:** **US D562,511 S**
(45) **Date of Patent:** **** Feb. 19, 2008**

(54) **VACUUM CLEANER HANDLE PORTION**

(75) Inventors: **Douglas J. Medema**, Belding, MI (US); **Bryce G. Rutter**, St. Louis, MO (US); **Marc W. Hunter**, St. Louis, MO (US); **Jeffery F. Feng**, St. Louis, MO (US); **David D. Kusch**, St. Louis, MO (US); **Melvin Joshua Leedle**, St. Louis, MO (US)

(73) Assignee: **Bissell Homecare, Inc.**, Grand Rapids, MI (US)

(**) Term: **14 Years**

(21) Appl. No.: **29/246,194**

(22) Filed: **Mar. 10, 2006**

(51) **LOC (8) Cl.** **15-05**

(52) **U.S. Cl.** **D32/34**

(58) **Field of Classification Search** D32/21-22, D32/31, 34; 15/328-329, 320-321, 323, 15/257.01, 347, 350-353, 361, 363, 366, 15/410-412, 414, 415.1, 335, 327.1

See application file for complete search history.

(56) **References Cited**

U.S. PATENT DOCUMENTS

D368,559 S * 4/1996 Abe et al. D32/22
D428,677 S 7/2000 Saunders et al.
D431,332 S * 9/2000 Hamm et al. D32/22
D435,708 S * 12/2000 Medema et al. D32/31

D451,655 S * 12/2001 Roberts et al. D32/34
D453,597 S 2/2002 Zahuranec et al.
D475,820 S 6/2003 Dyson et al.
D490,951 S * 6/2004 Leyden D32/34
D521,698 S * 5/2006 Rosenzweig et al. D32/22
D522,200 S 5/2006 Scheifele et al.
D530,473 S * 10/2006 Medema et al. D32/31

* cited by examiner

Primary Examiner—Ruth McInroy

(74) *Attorney, Agent, or Firm*—McGarry Bair PC

(57) **CLAIM**

The ornamental design for a vacuum cleaner handle portion, as shown and described.

DESCRIPTION

FIG. 1 is a front perspective view of a vacuum cleaner handle portion which embodies our design;

FIG. 2 is a front view thereof;

FIG. 3 is a rear view thereof;

FIG. 4 is a right side view thereof;

FIG. 5 is a left side view thereof;

FIG. 6 is a top view thereof; and,

FIG. 7 is a bottom view thereof.

The details shown in broken lines form no part of the claimed design.

1 Claim, 6 Drawing Sheets

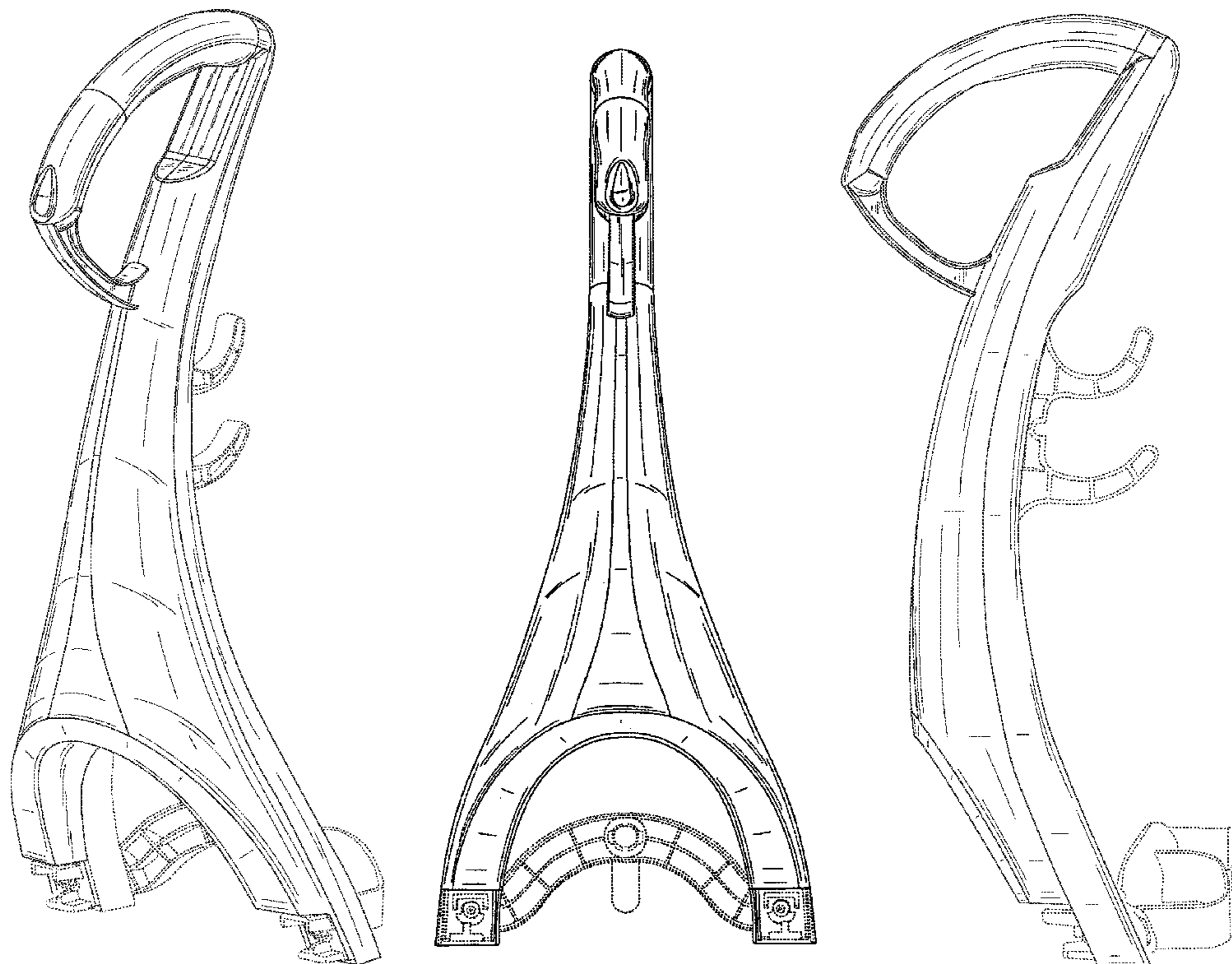

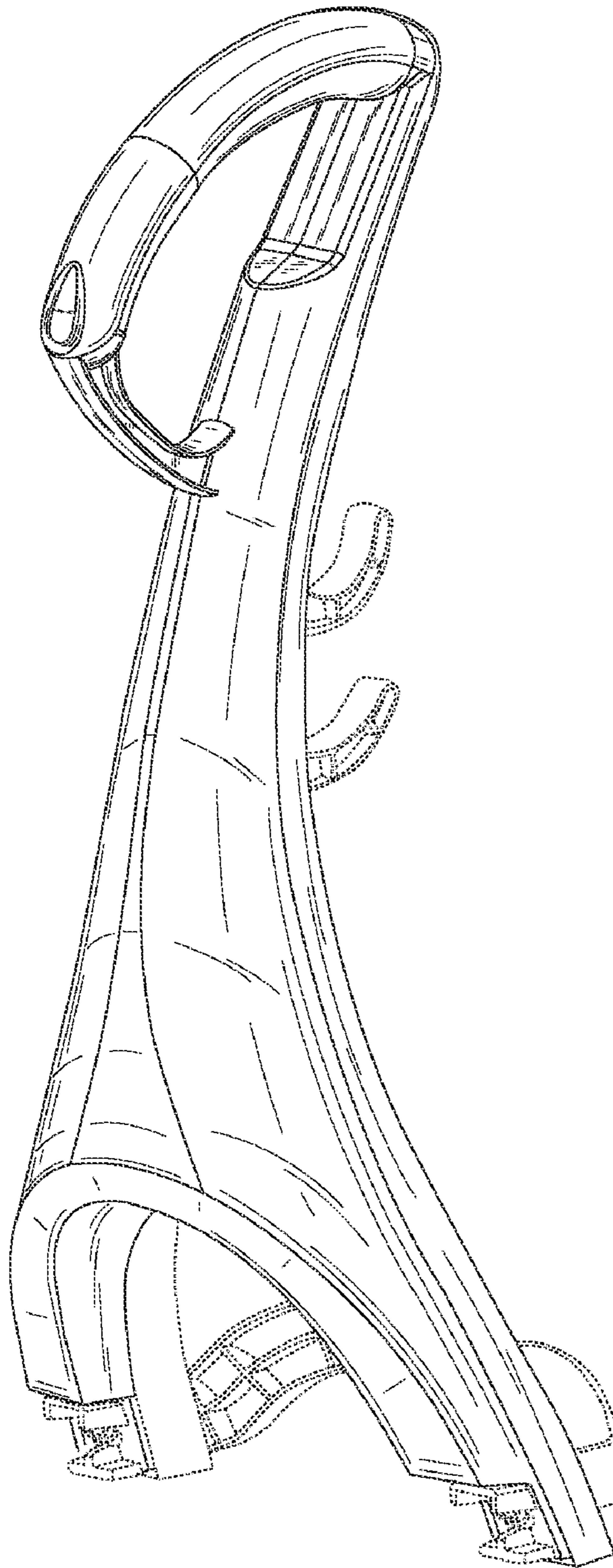

Fig. 1

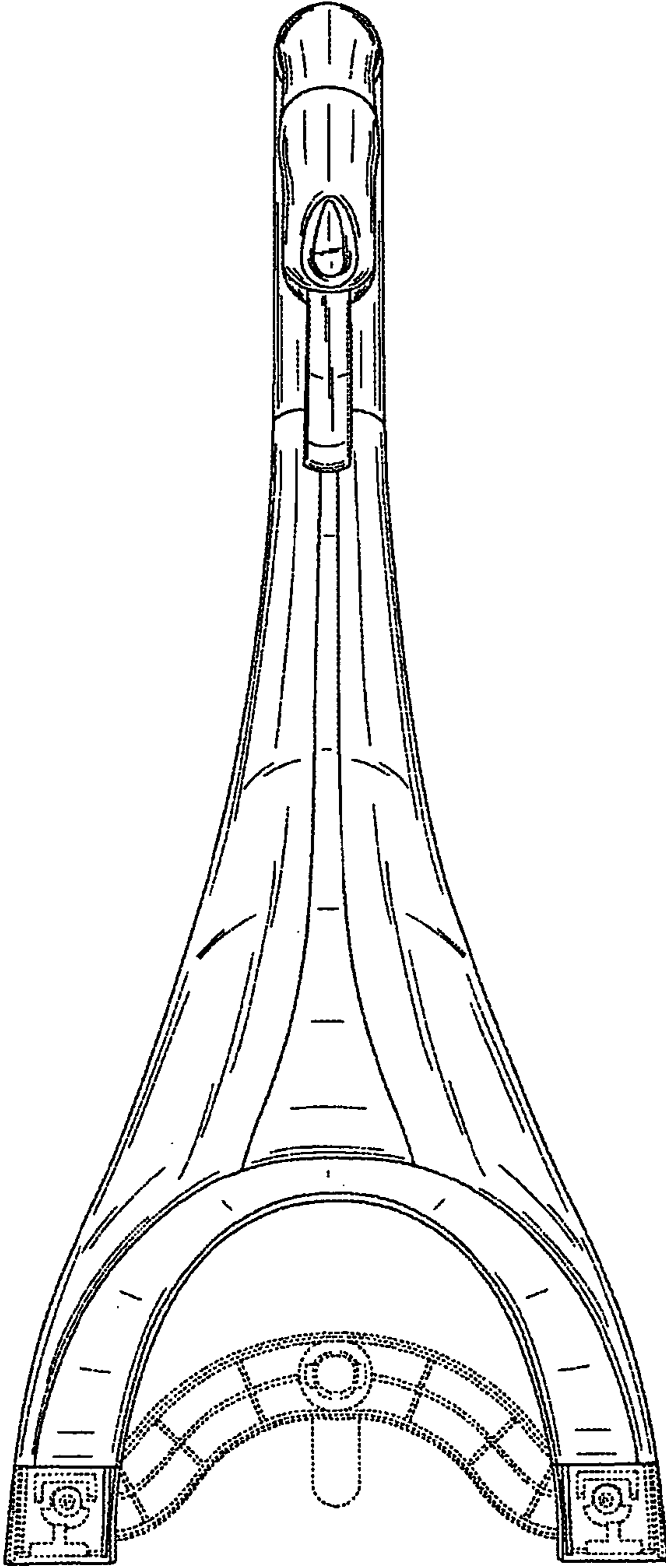

Fig. 2

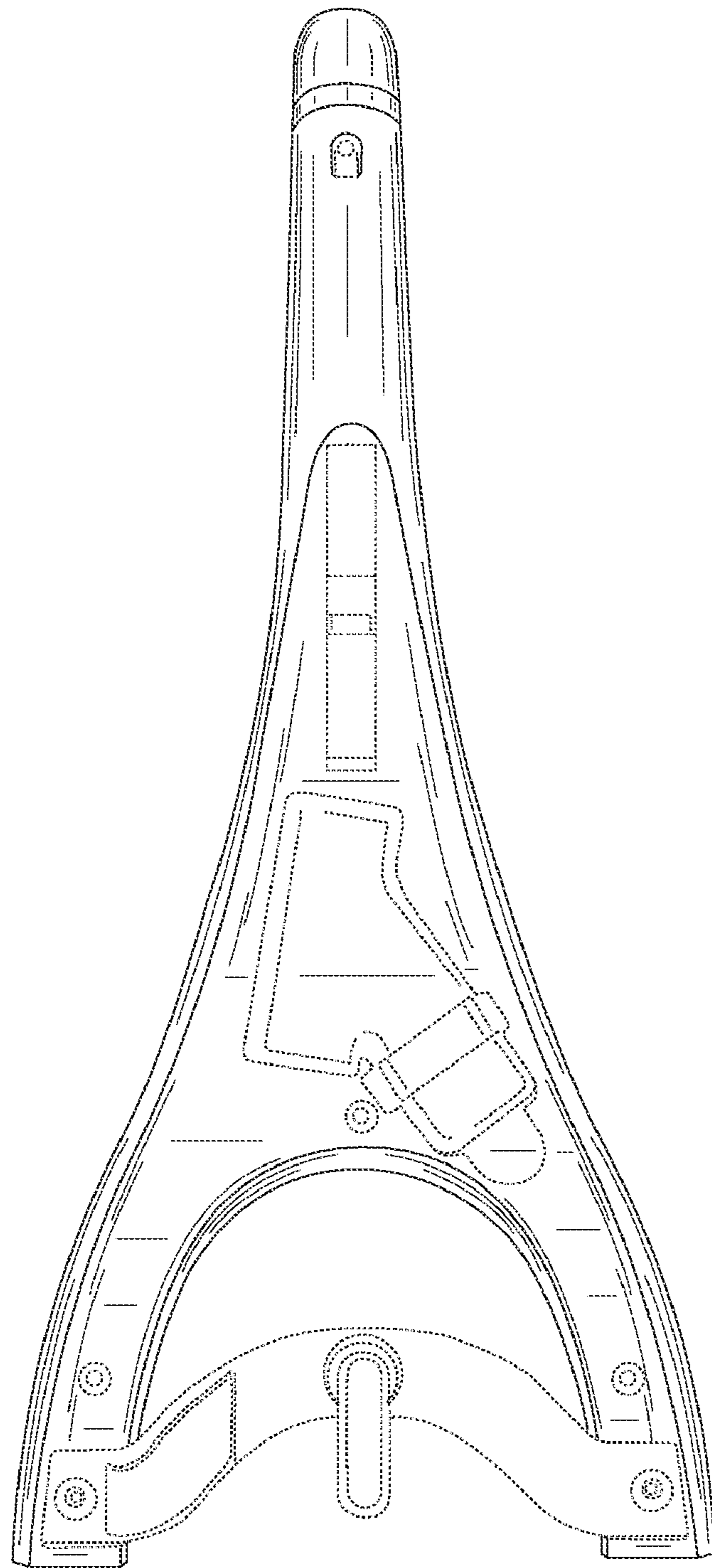

Fig. 3

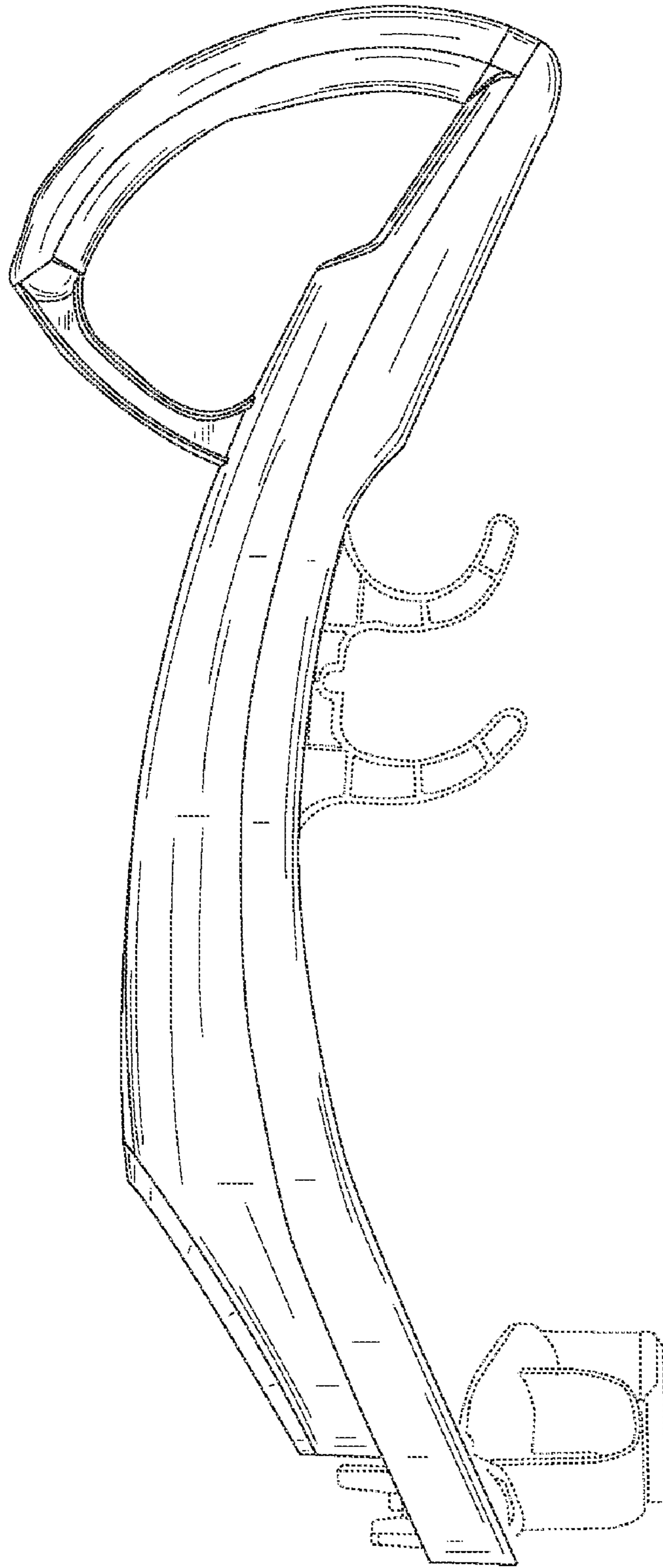

Fig. 4

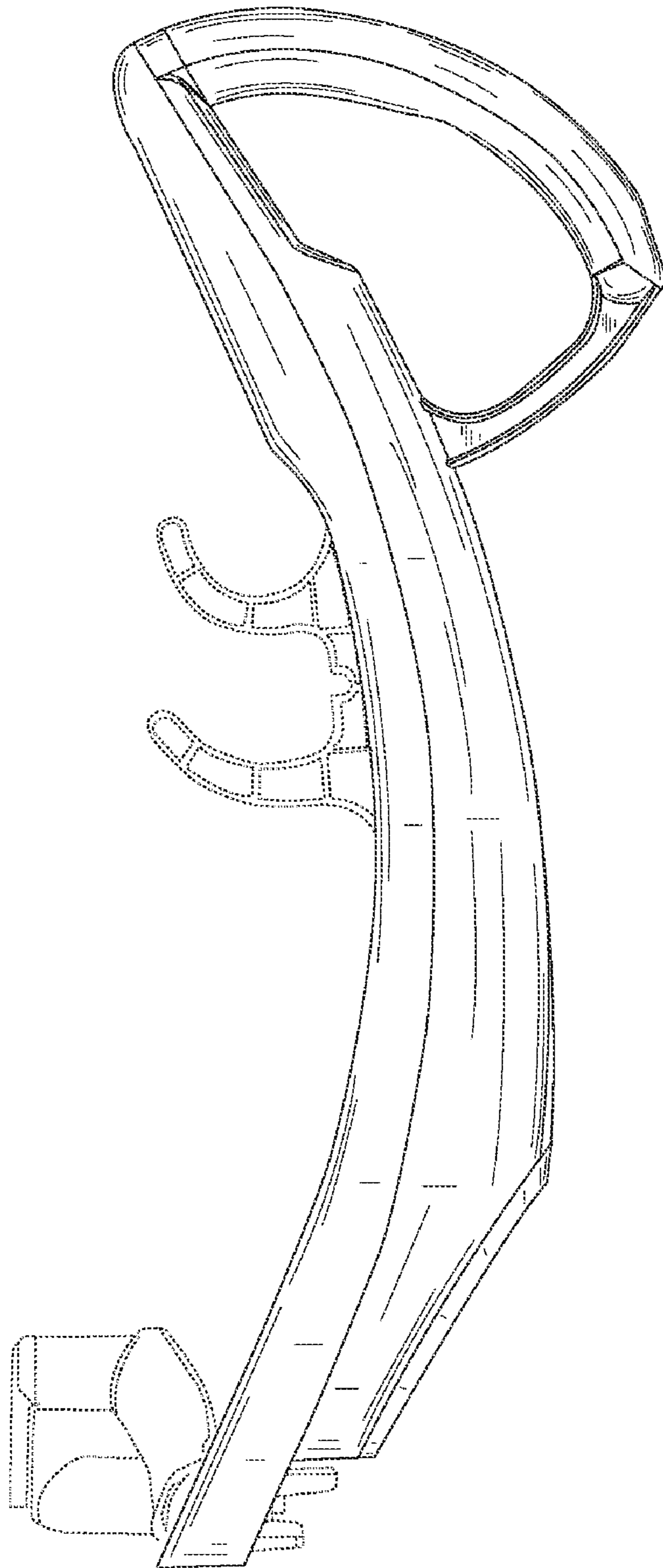

Fig. 5

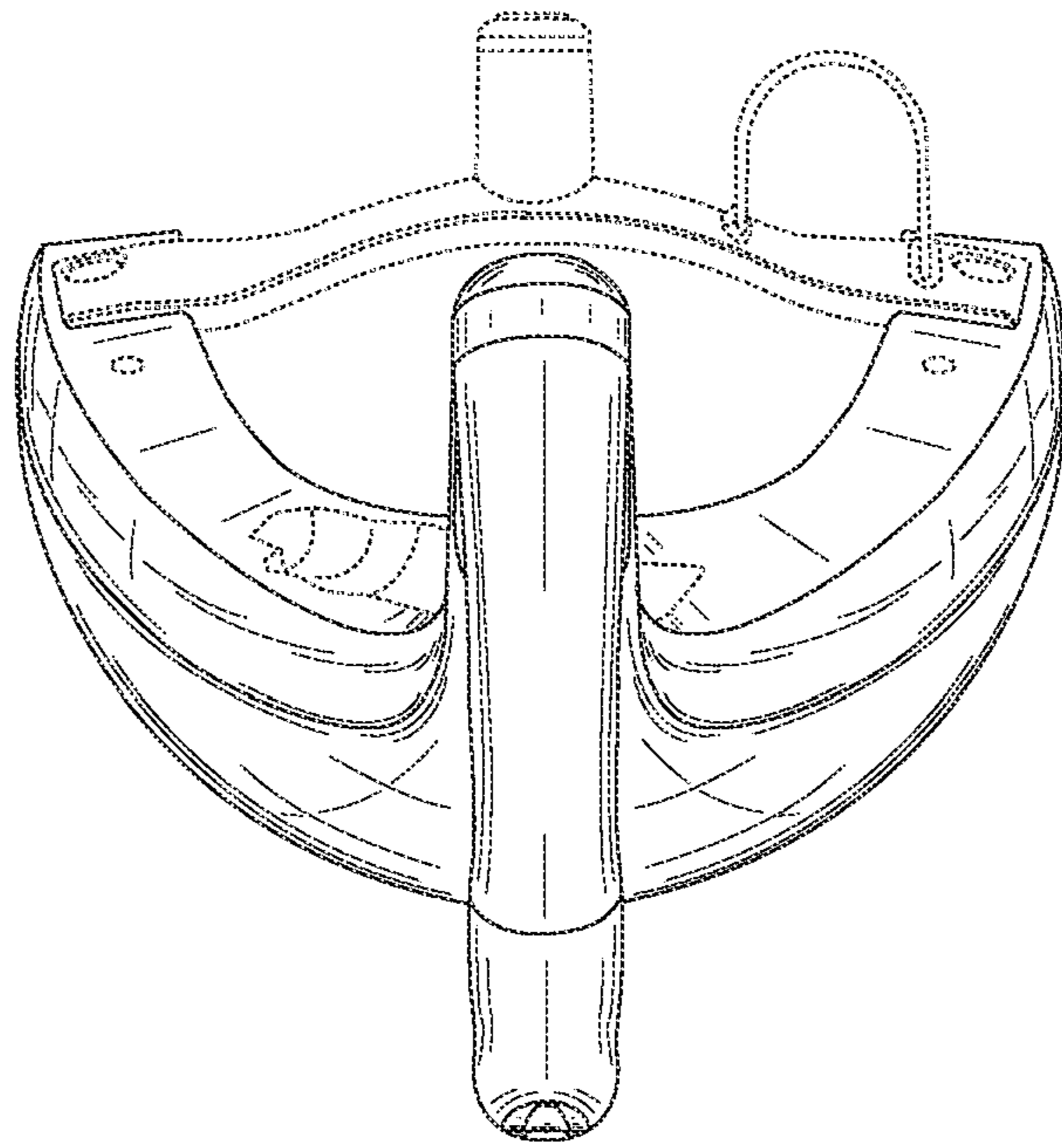

Fig. 6

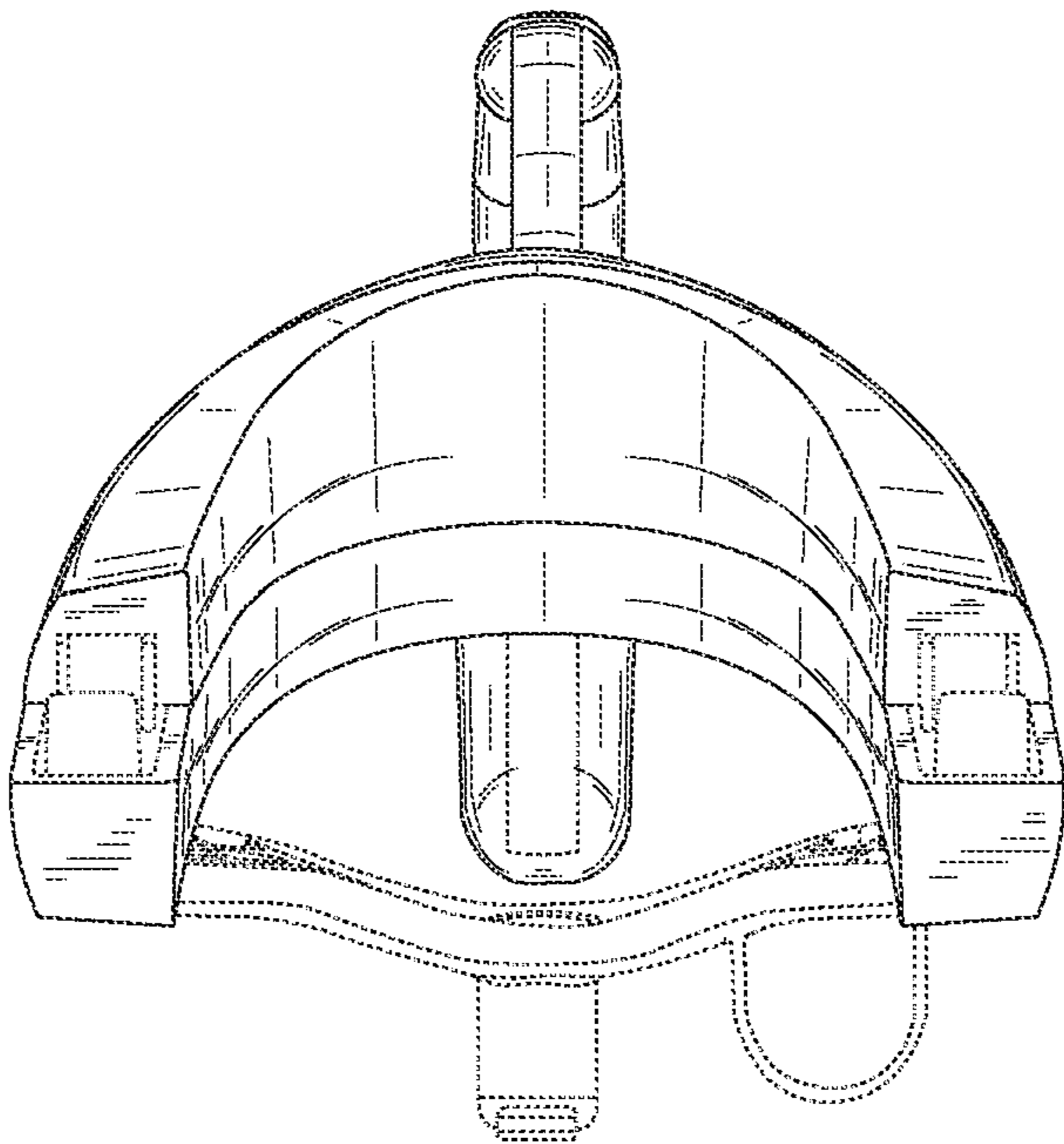

Fig. 7