



US00D562424S

(12) **United States Design Patent**  
**McKee**

(10) **Patent No.:** **US D562,424 S**  
(45) **Date of Patent:** **\*\* Feb. 19, 2008**

(54) **WATER SPORT BOARD**

(76) Inventor: **William Douglas McKee**, 17  
Homelands Avenue, Feilding (NZ) 5600

(\*\*) Term: **14 Years**

(21) Appl. No.: **29/276,357**

(22) Filed: **Jan. 23, 2007**

**Related U.S. Application Data**

(63) Continuation of application No. 29/254,832, filed on Feb. 28, 2006, now abandoned, which is a continuation-in-part of application No. 29/223,301, filed on Feb. 11, 2005, now Pat. No. Des. 545,392.

(51) **LOC (8) Cl.** ..... **21-02**

(52) **U.S. Cl.** ..... **D21/769**

(58) **Field of Classification Search** ..... D21/769-770,  
D21/801, 803, 809; 472/128-129; D12/5,  
D12/6, 316; 114/253, 346; 441/35, 66, 40-42,  
441/129-132

See application file for complete search history.

(56) **References Cited**

**U.S. PATENT DOCUMENTS**

D188,094 S \* 6/1960 McWethy ..... D32/35  
D192,932 S \* 5/1962 Gurr ..... D21/828  
3,135,978 A \* 6/1964 Grasmoen ..... 441/66

**FOREIGN PATENT DOCUMENTS**

AU 302707 8/2005

*Primary Examiner*—Janice E. Seeger

*Assistant Examiner*—Zenita I. Bennett

(74) *Attorney, Agent, or Firm*—Dann, Dorfman, Herrell and Skillman, P.C.

(57) **CLAIM**

The ornamental design for a water sport board, as shown and described.

**DESCRIPTION**

FIG. 1 is a top plan view of a first embodiment of a water sport board;

FIG. 2 is a bottom plan view thereof;

FIG. 3 is a front view thereof;

FIG. 4 is a left-hand side view thereof, the right-hand side being a mirror image thereof;

FIG. 5 is a top front perspective view thereof;

FIG. 6 is a top rear perspective view thereof;

FIG. 7 is a bottom front perspective view thereof;

FIG. 8 is top plan view of a second embodiment of the water sport board;

FIG. 9 is a bottom plan view thereof;

FIG. 10 is a front view thereof;

FIG. 11 is a left-hand side view thereof, the right-hand side being a mirror image thereof;

FIG. 12 is a top front perspective view thereof;

FIG. 13 is a bottom front perspective view thereof;

FIG. 14 is a top plan view of a third embodiment of the water sport board;

FIG. 15 is a bottom plan view thereof;

FIG. 16 is a front view thereof;

FIG. 17 is a left-hand side view thereof, the right-hand side being a mirror image thereof;

FIG. 18 is a top front perspective view thereof;

FIG. 19 is a bottom front perspective view thereof;

FIG. 20 is a top plan view of a fourth embodiment of the water sport board;

FIG. 21 is a bottom plan view thereof;

FIG. 22 is a front view thereof;

FIG. 23 is a left-hand side view thereof, the right-hand side being a mirror image thereof;

FIG. 24 is a top front perspective view thereof; and,

FIG. 25 is a bottom front perspective view thereof.

The features shown in broken lines in the drawing figures are environmental structure that form no part of the design to be patented.

**1 Claim, 20 Drawing Sheets**

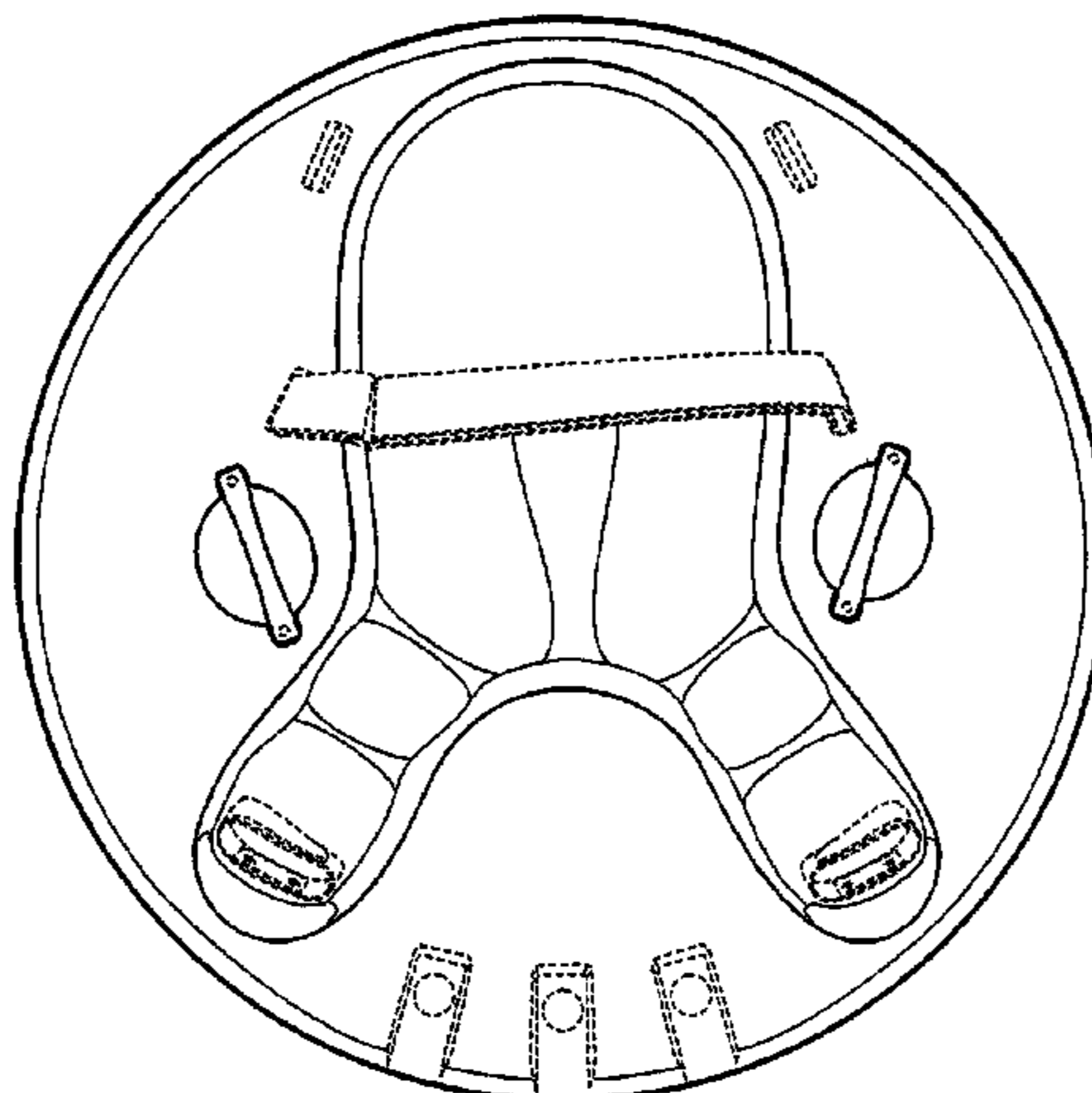

# US D562,424 S

Page 2

## U.S. PATENT DOCUMENTS

3,335,440 A \* 8/1967 Beakbane ..... 441/67  
3,380,090 A \* 4/1968 Kenmuir ..... 114/357  
D226,633 S \* 4/1973 Beck ..... D21/769  
D228,258 S \* 8/1973 McClure ..... D12/316  
3,777,325 A 12/1973 Bristol  
D232,964 S \* 9/1974 Smith ..... D21/769  
D276,359 S \* 11/1984 Churchill ..... D21/769  
4,629,434 A 12/1986 Monreal  
4,857,025 A 8/1989 Brown et al.  
4,894,034 A 1/1990 Brown, III  
D306,631 S \* 3/1990 Aguilar et al. .... D21/769  
5,257,953 A 11/1993 Gillis  
5,700,174 A 12/1997 Churchill et al.  
D397,286 S \* 8/1998 Dreyfus et al. .... D8/358  
D407,779 S \* 4/1999 Peterson ..... D21/803  
5,934,961 A 8/1999 Mehrmann et al.  
D432,199 S \* 10/2000 Peterson ..... D21/803  
6,203,389 B1 3/2001 Pearson  
D462,406 S \* 9/2002 Kessler ..... D21/769  
D473,161 S \* 4/2003 Inkster ..... D12/5  
6,648,707 B1 \* 11/2003 Peterson ..... 441/66

2004/0176000 A1 9/2004 Mann

## FOREIGN PATENT DOCUMENTS

AU 302708 8/2005  
AU 302709 8/2005  
AU 302710 8/2005  
DE 26 24 401 12/1977  
EM 000300330-0001 5/2005  
EM 000300330-0002 5/2005  
EM 000300330-0003 5/2005  
EM 000300330-0004 5/2005  
WO WO 99/17984 4/1999  
WO WO 05/028294 3/2005  
WO WO 05/079934 9/2005  
WO WO 06/068506 6/2006  
ZA A2005/0223 2/2005  
ZA A2005/0224 2/2005  
ZA A2005/0225 2/2005  
ZA A2005/0226 2/2005

\* cited by examiner

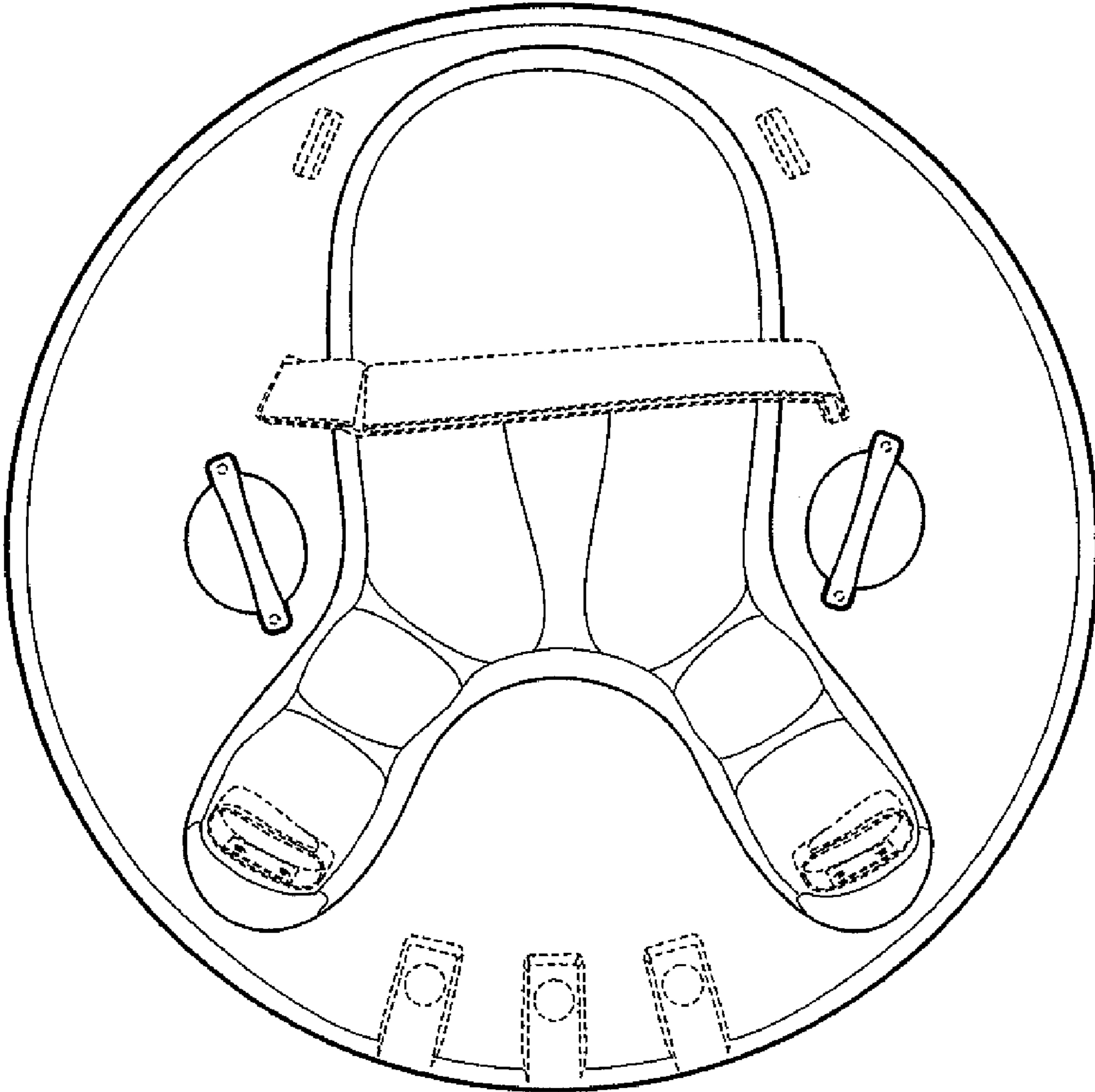

FIG. 1

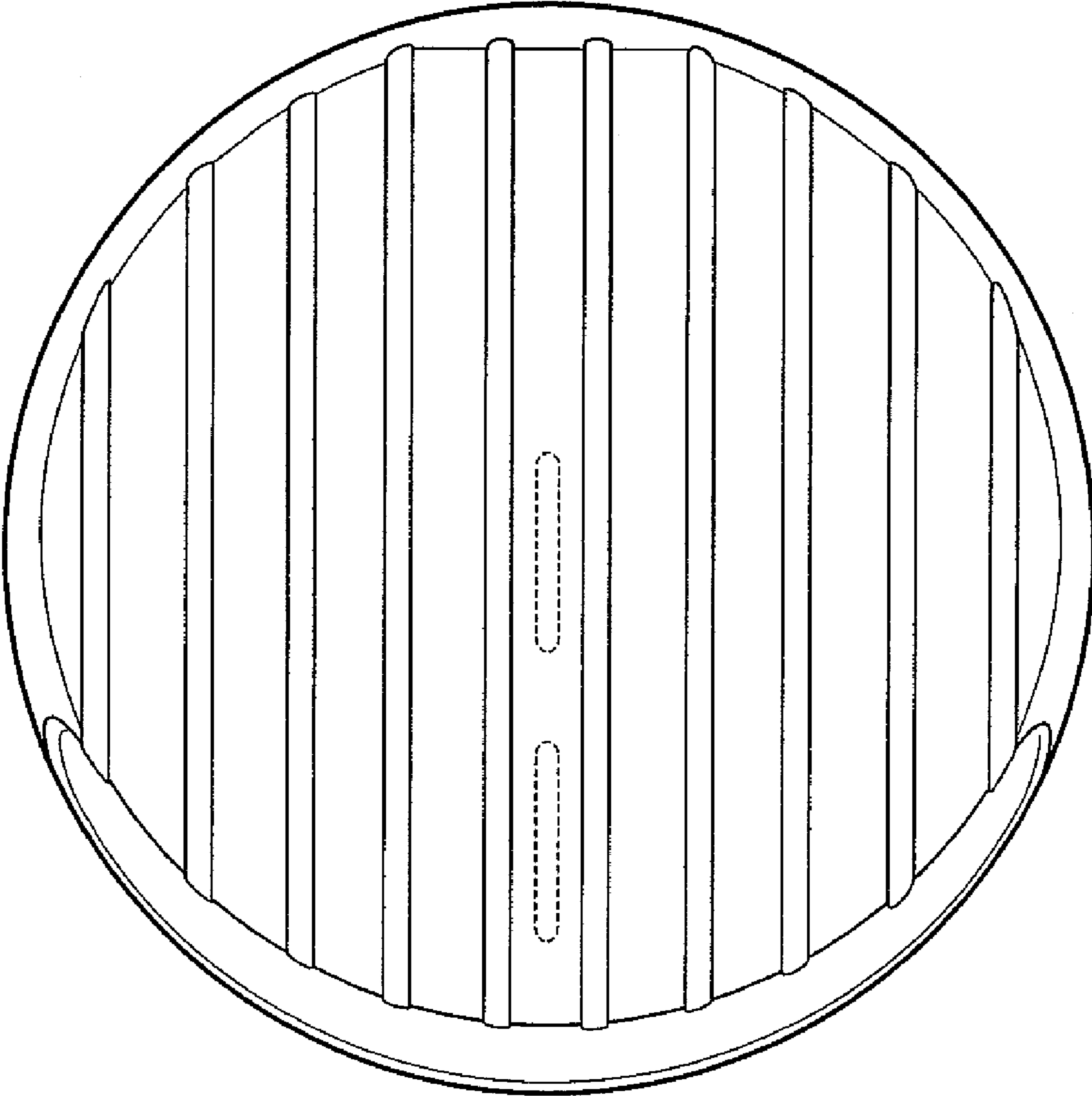

FIG. 2

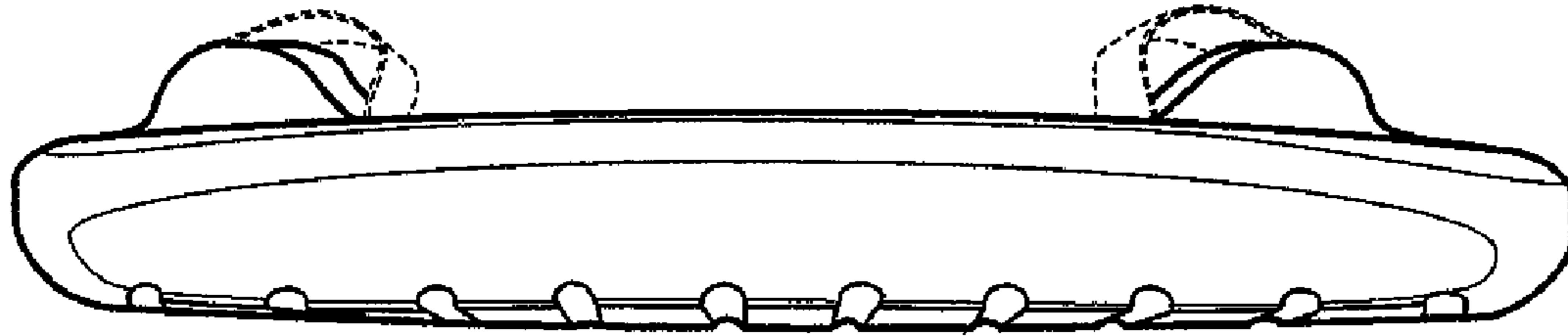

FIG. 3

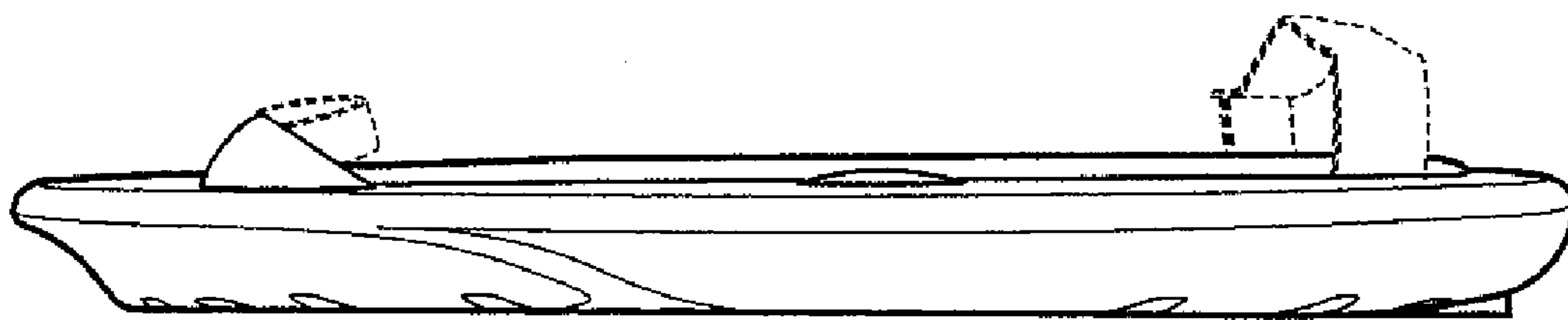

FIG. 4

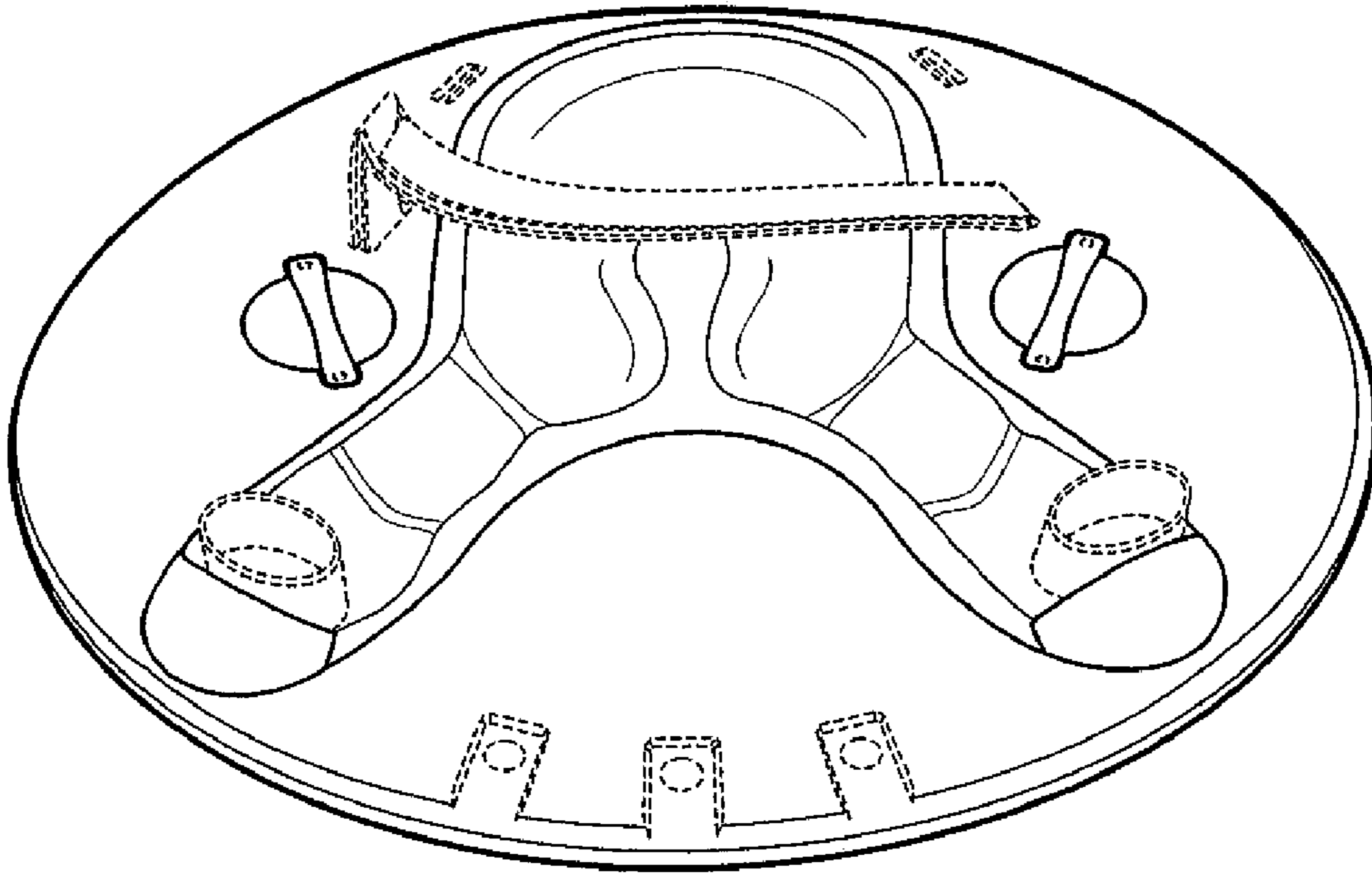

FIG. 5

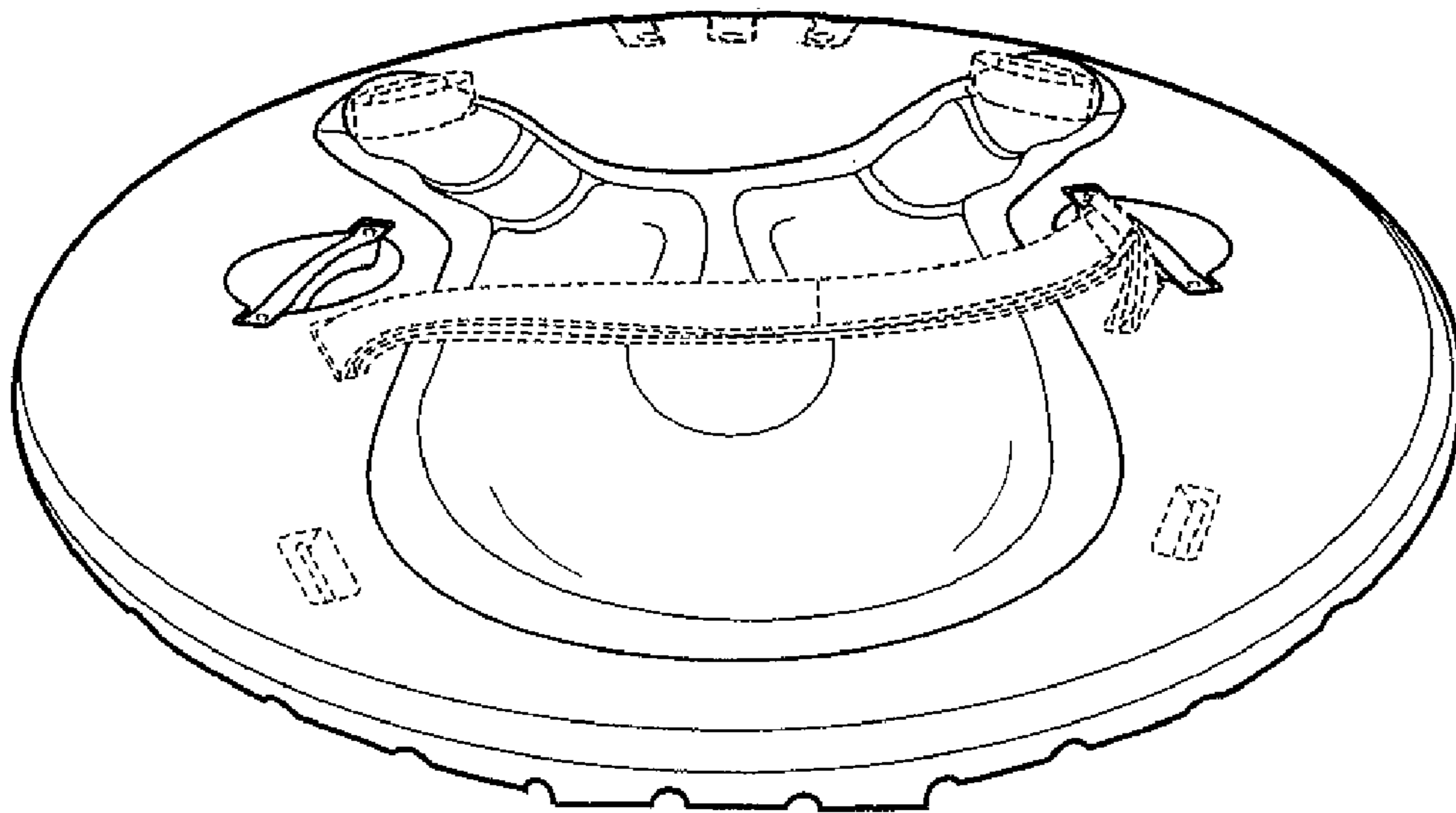

FIG. 6

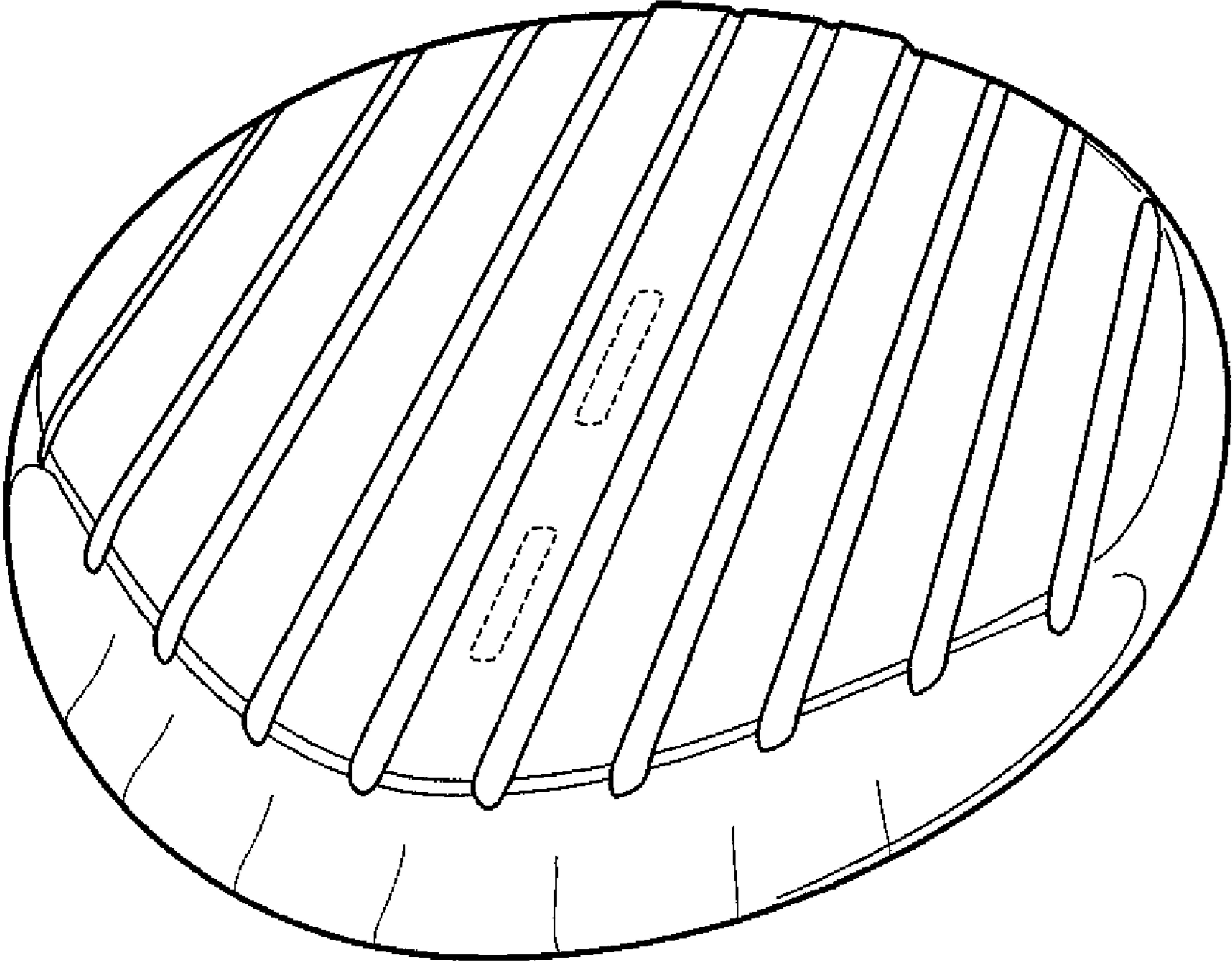

FIG. 7

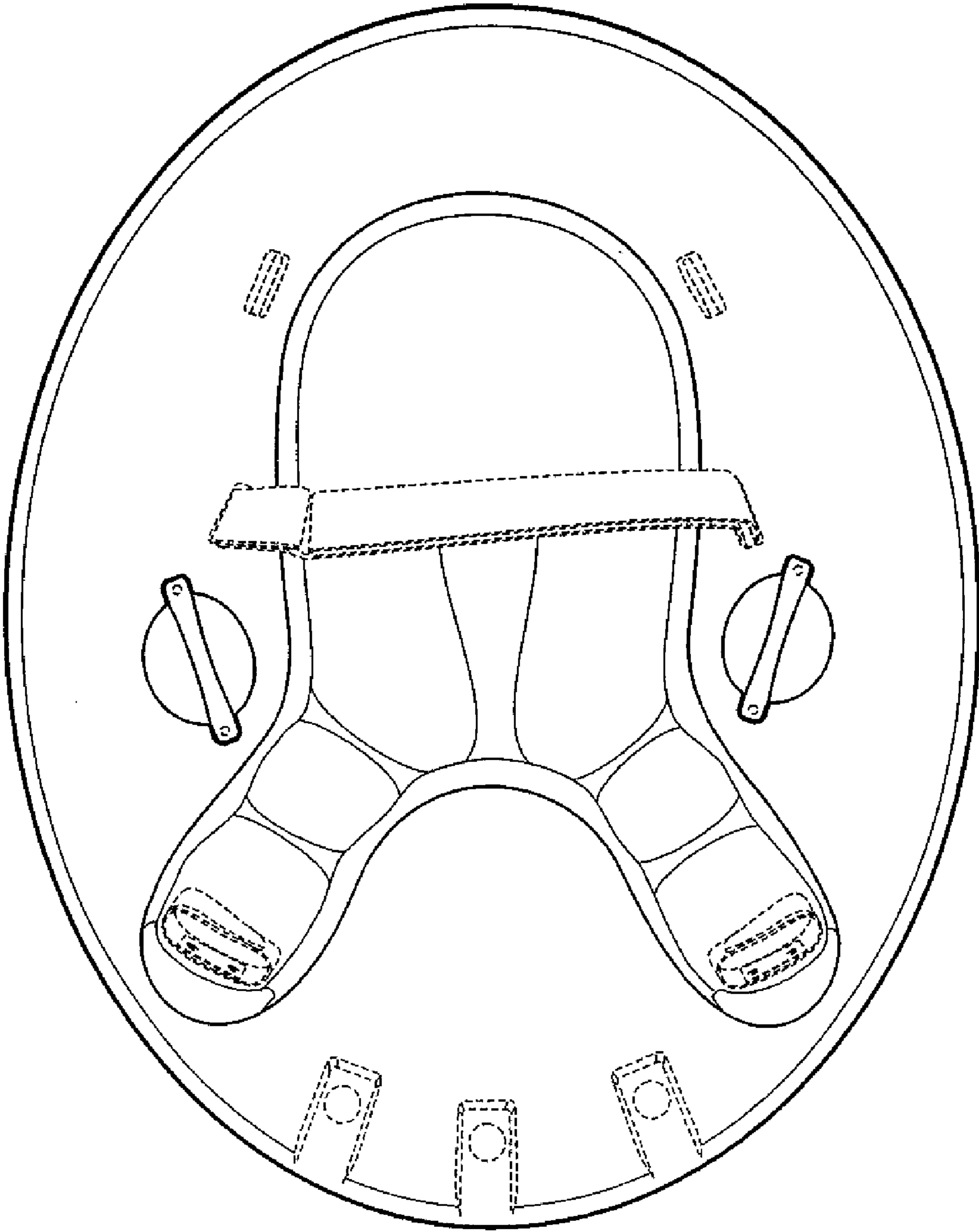

FIG. 8



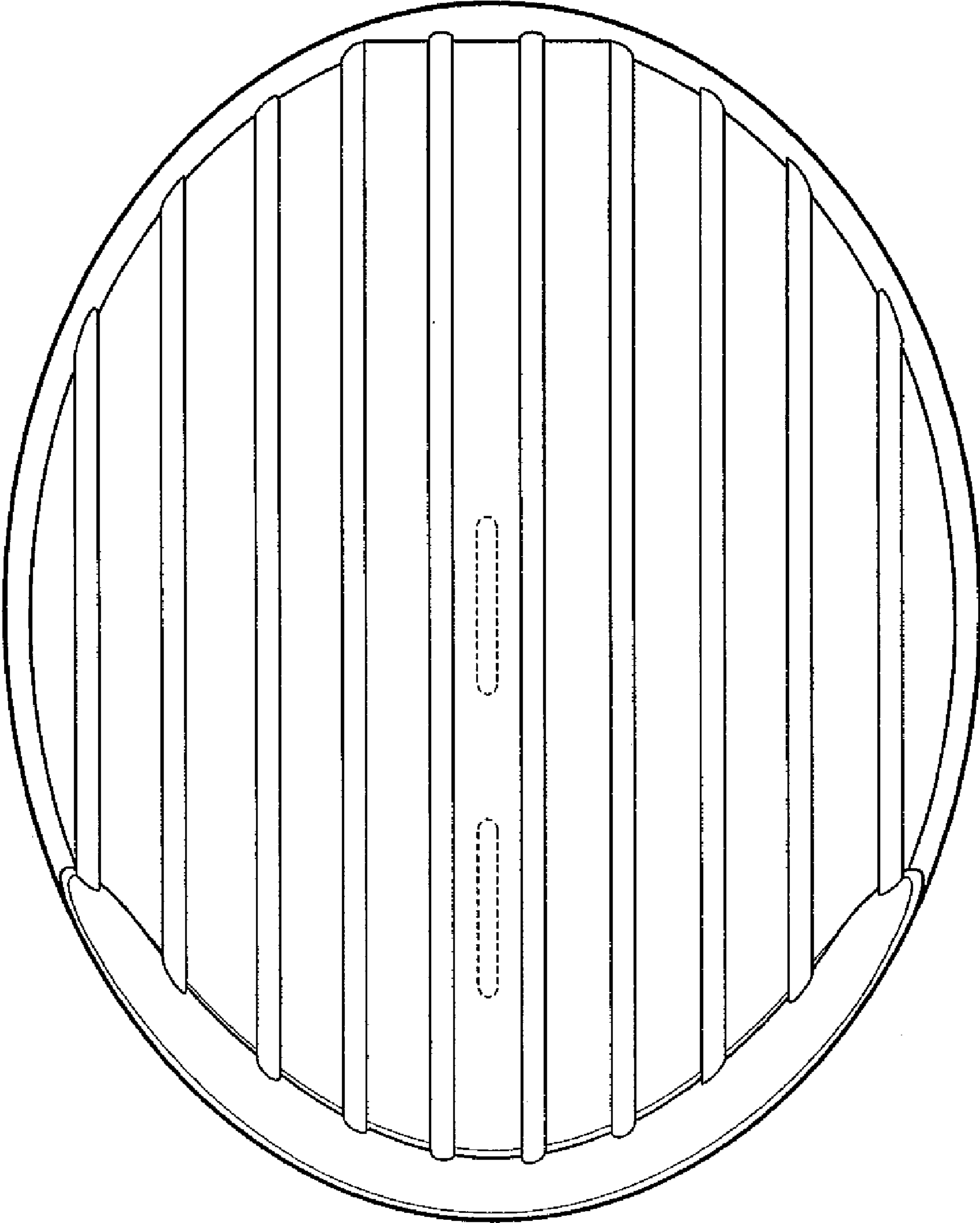

FIG. 9

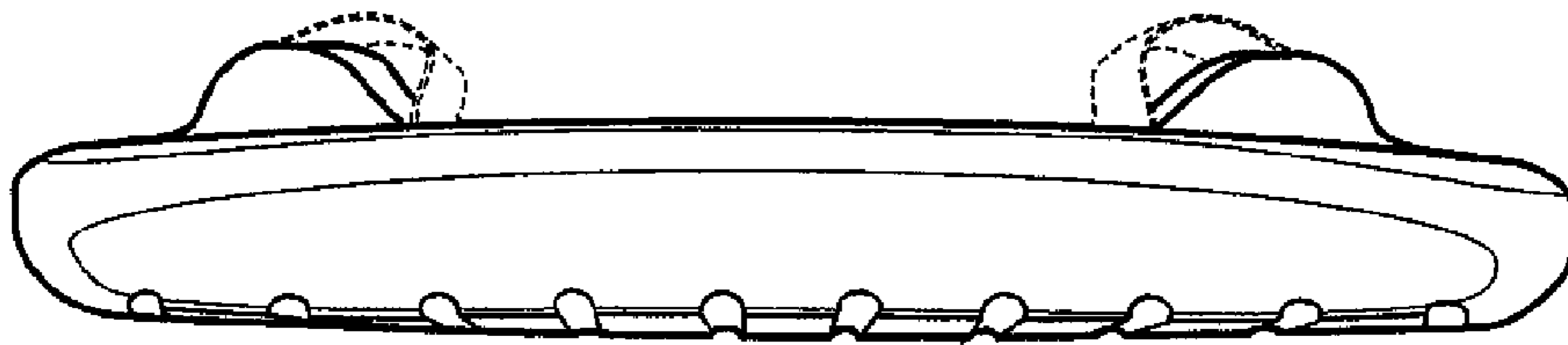

FIG. 10

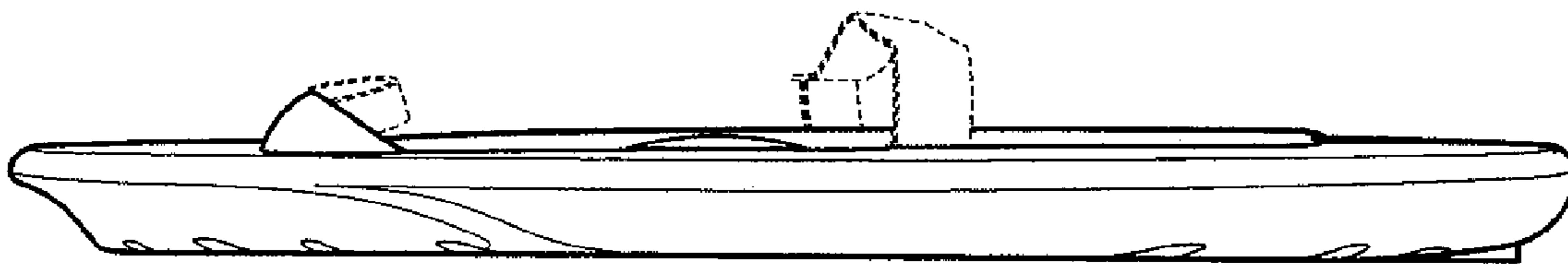

FIG. 11

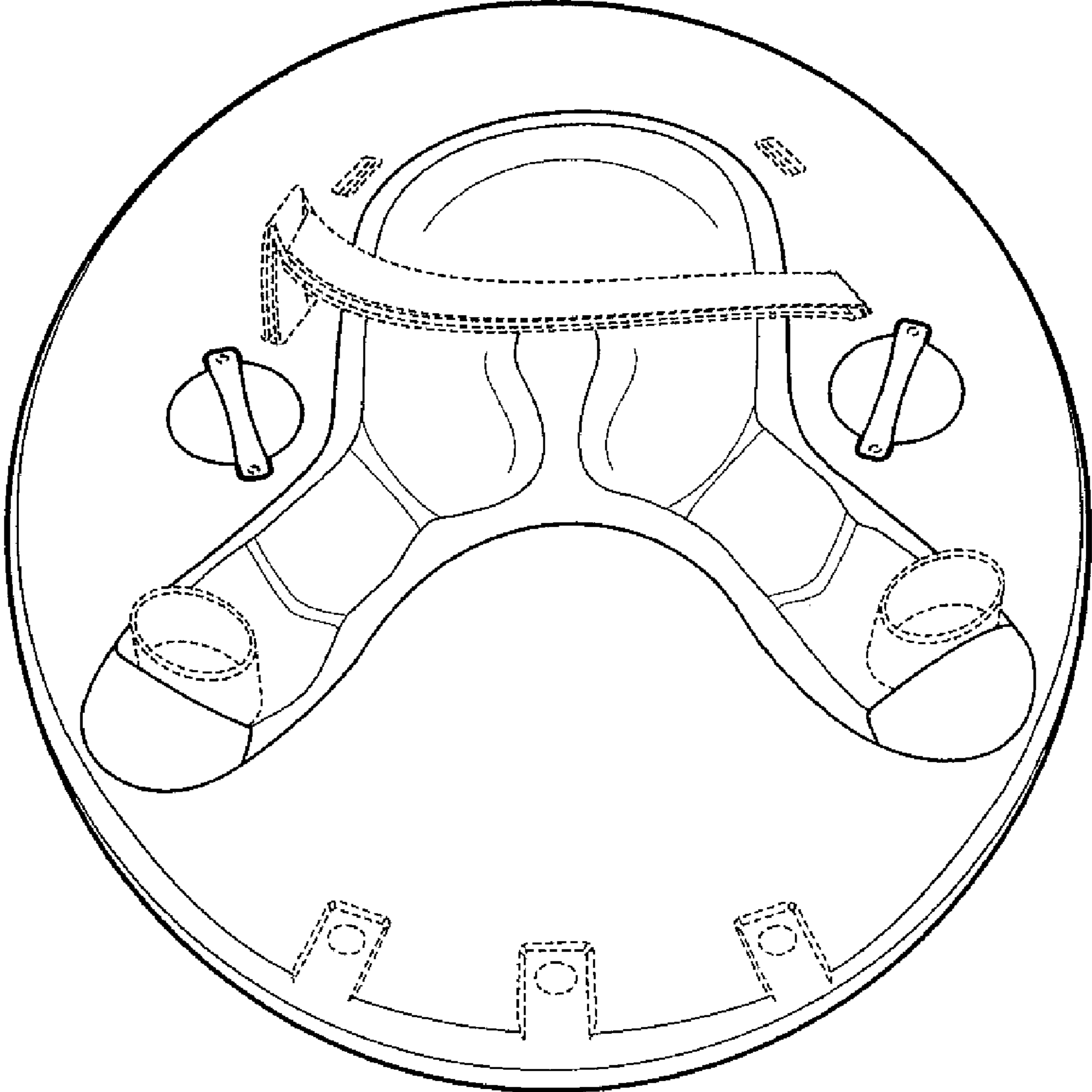

FIG. 12

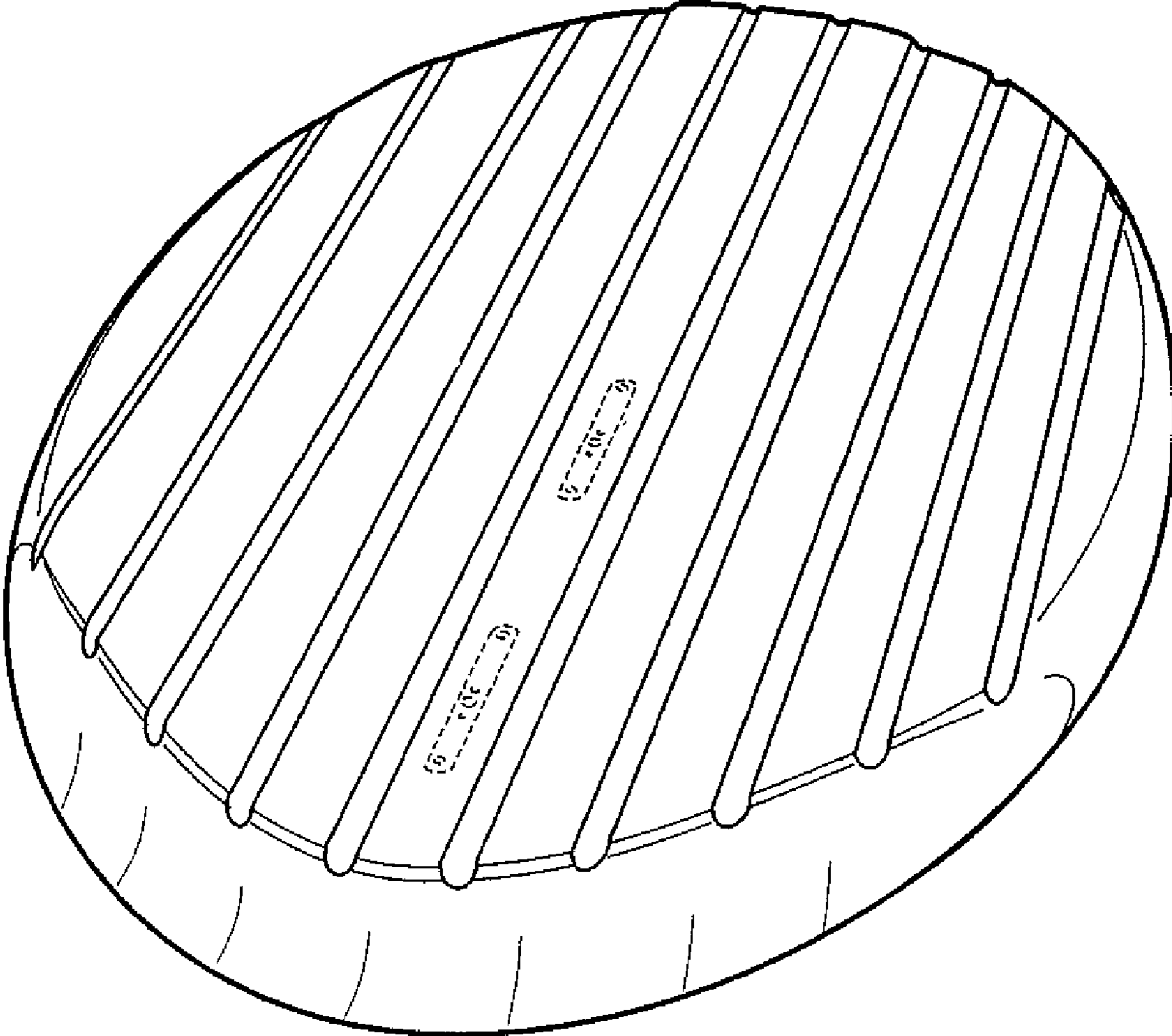

FIG. 13

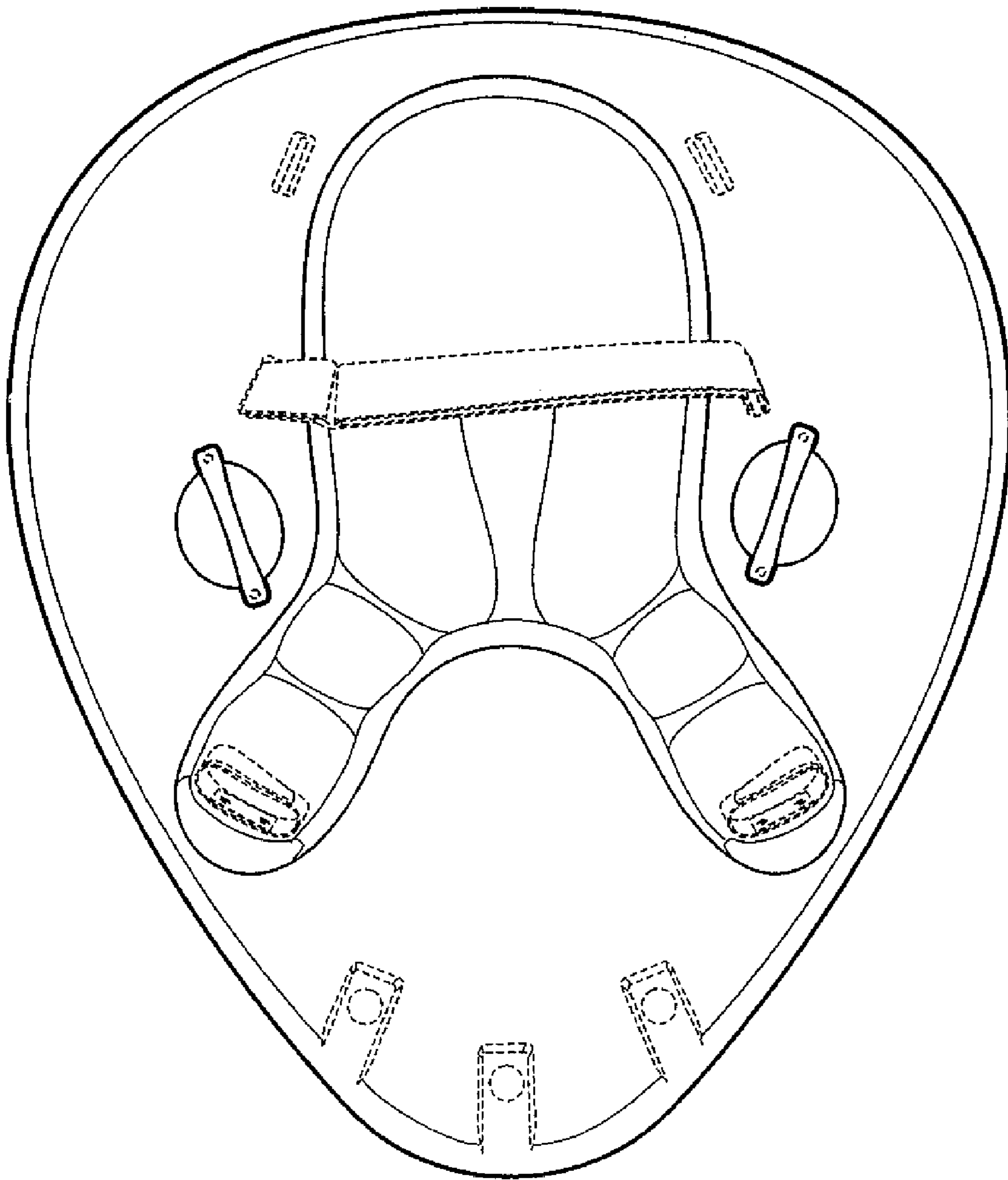

FIG. 14

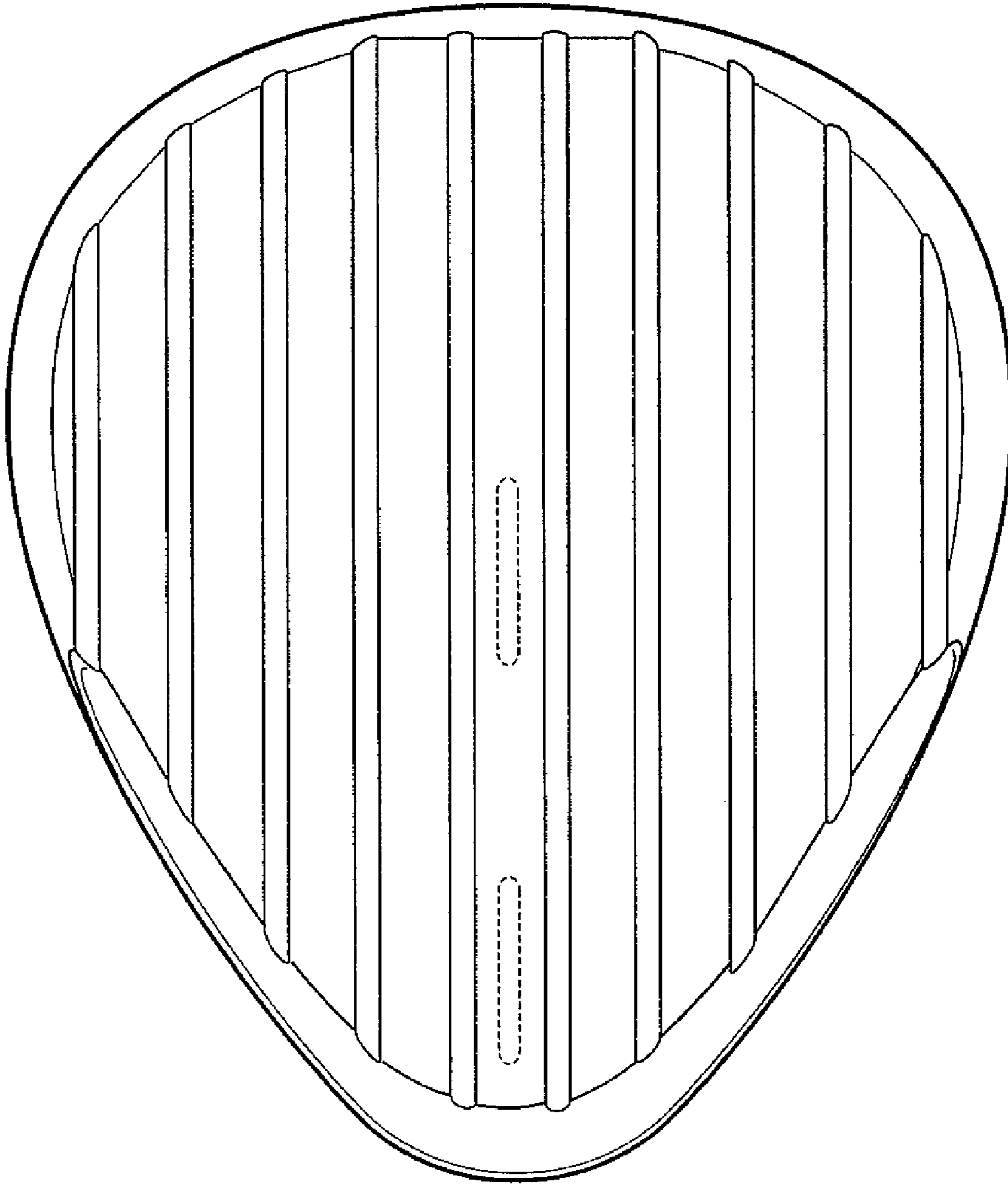

FIG. 15

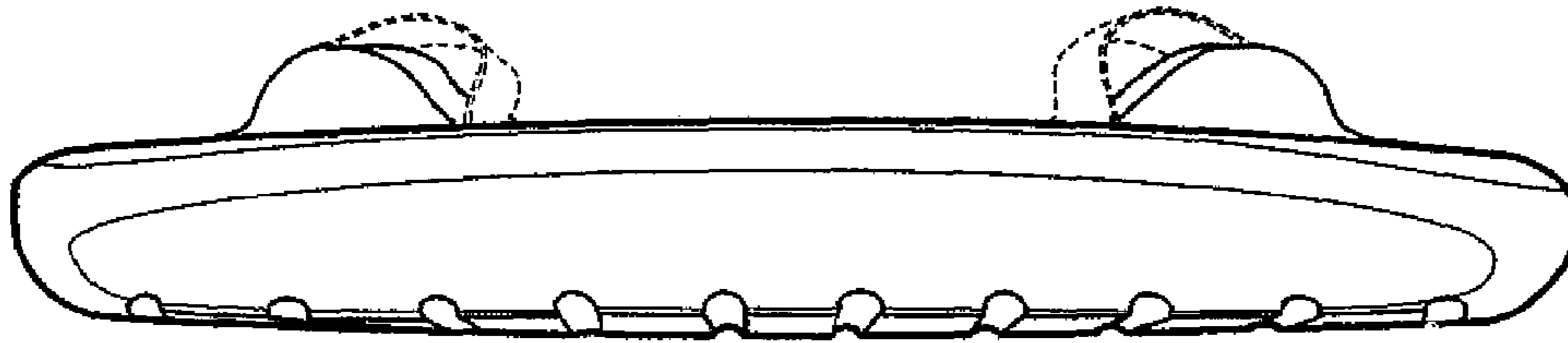

FIG. 16

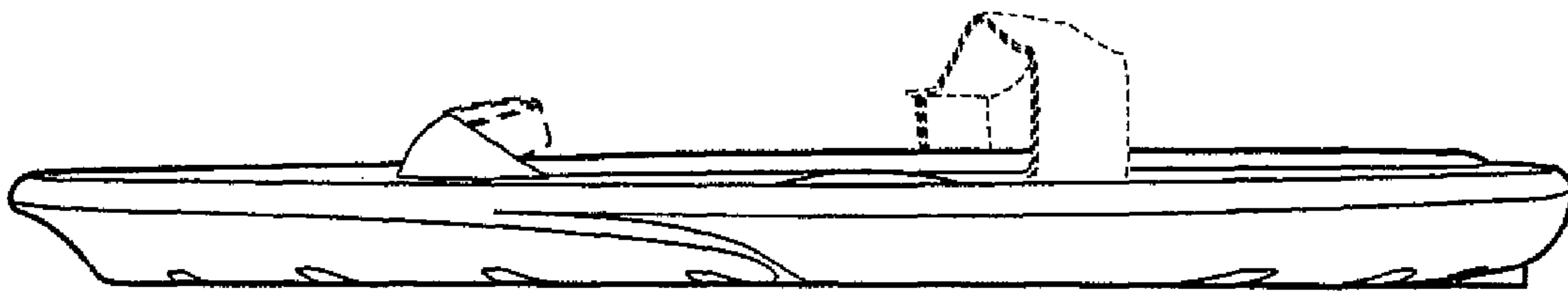

FIG. 17

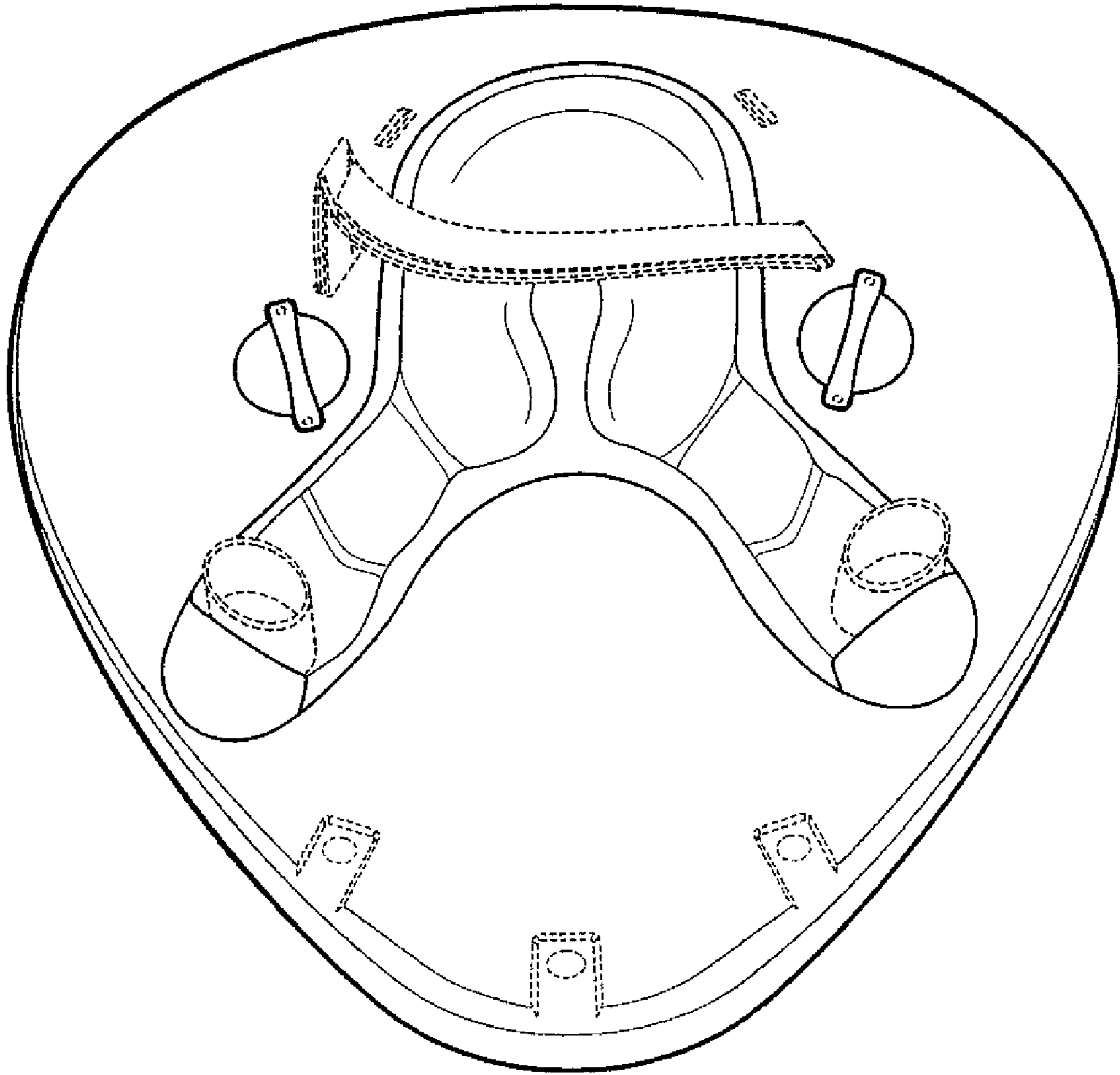

FIG. 18



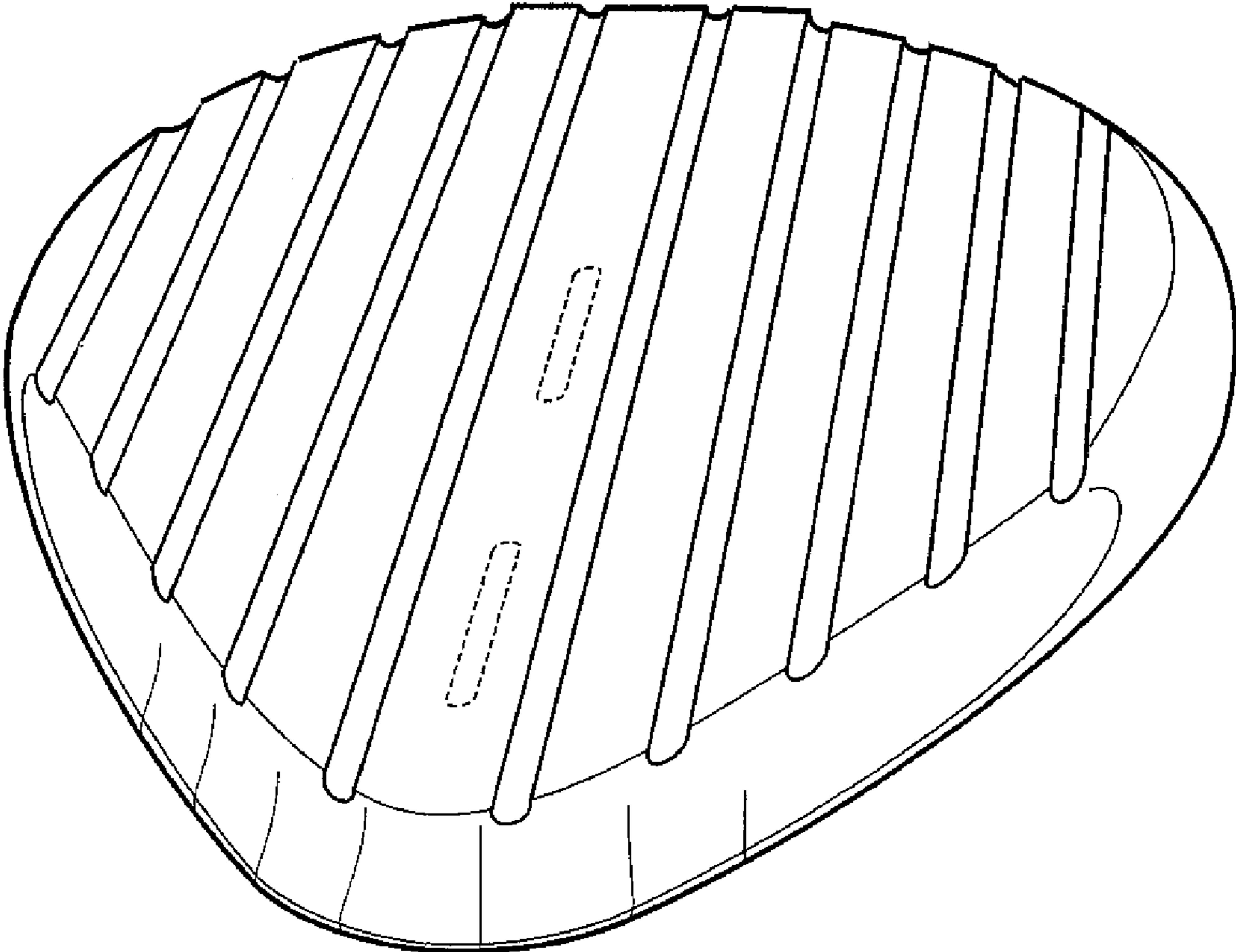

FIG. 19

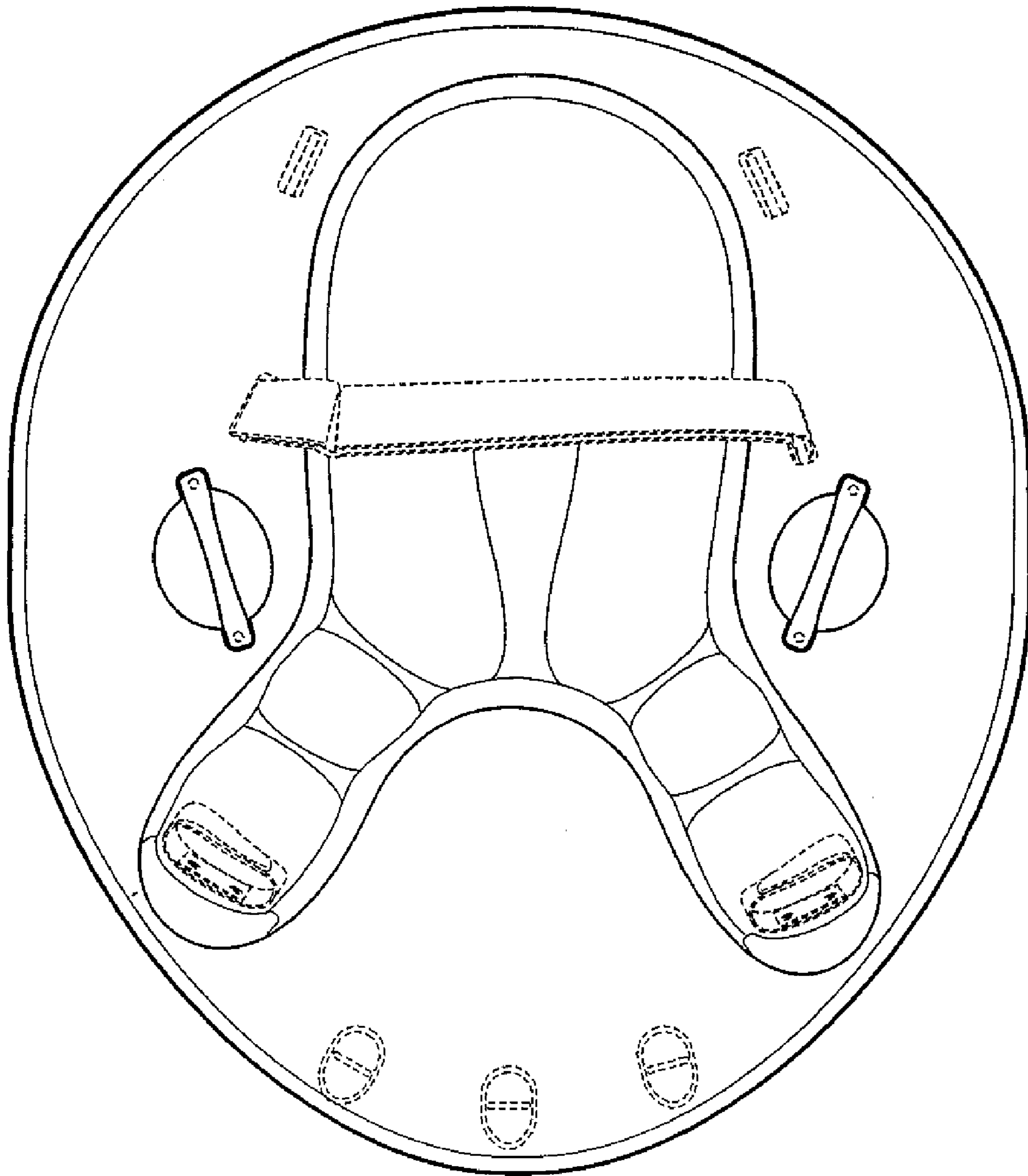

FIG. 20

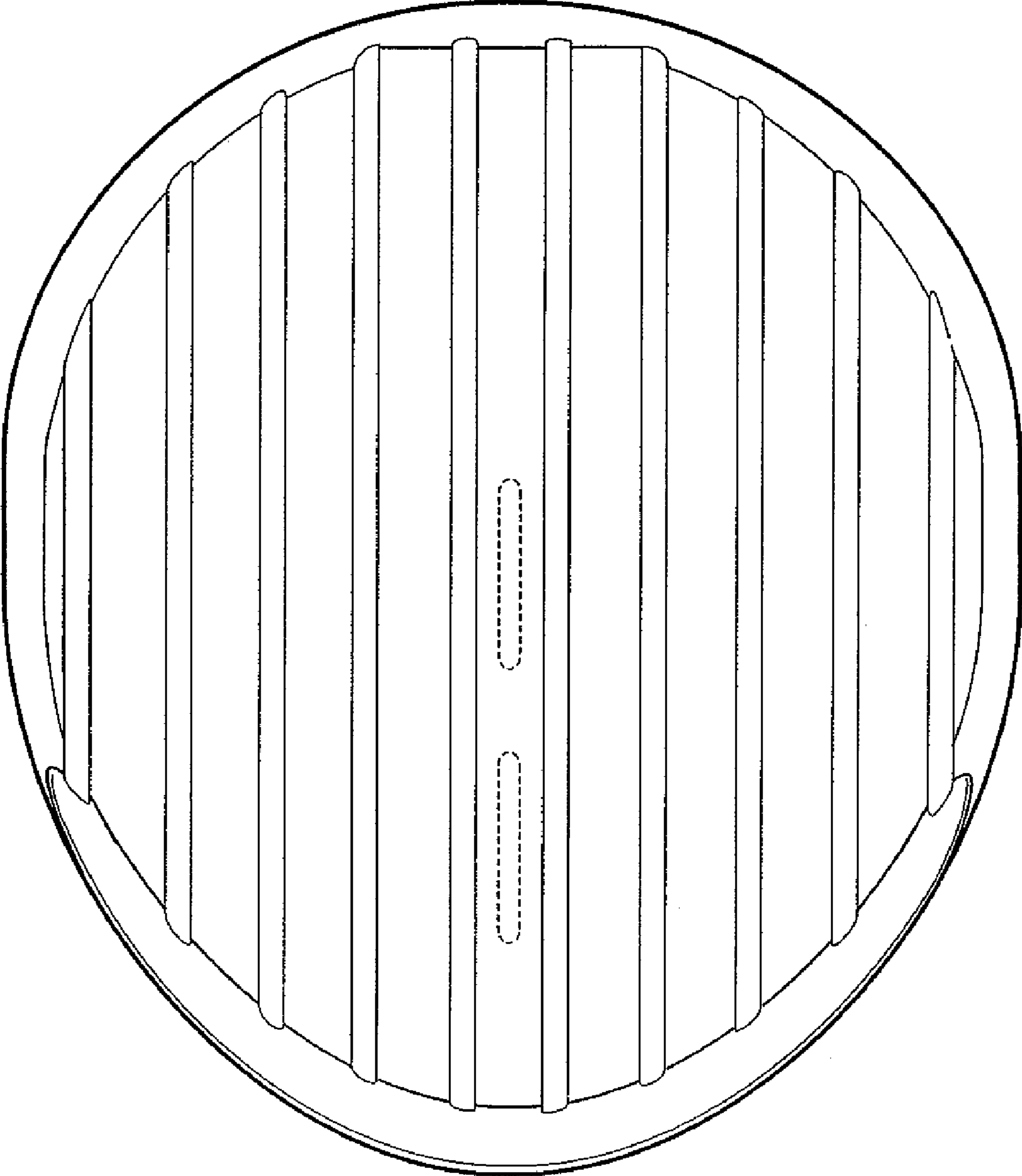

FIG. 21

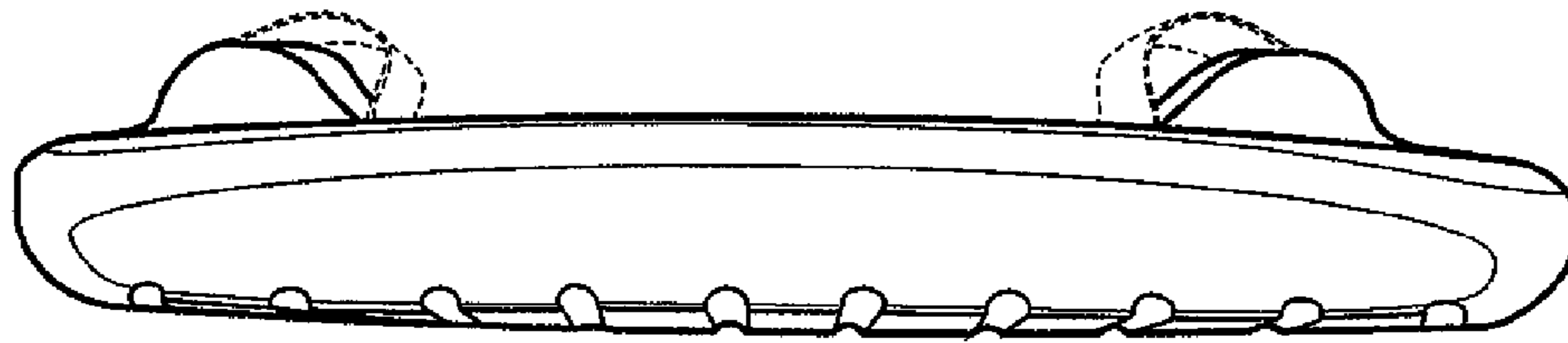

FIG. 22

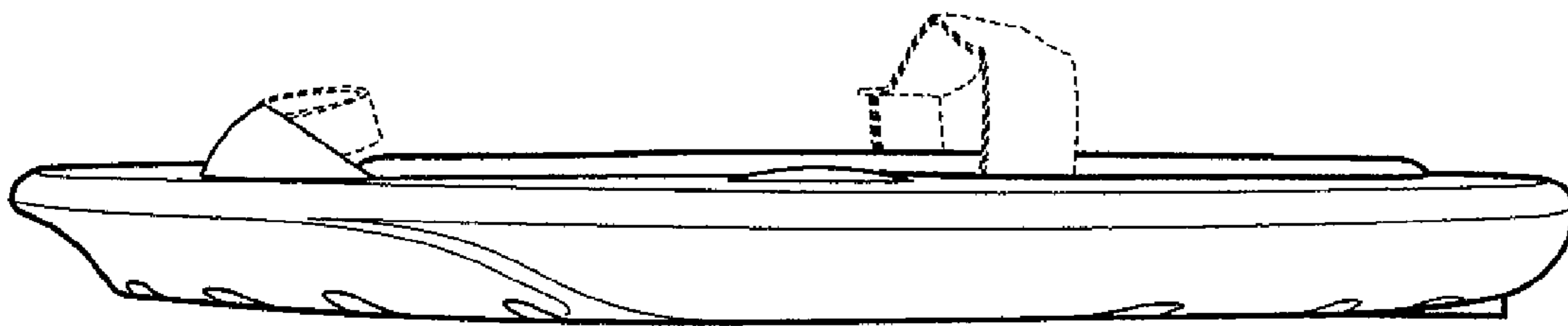

FIG. 23

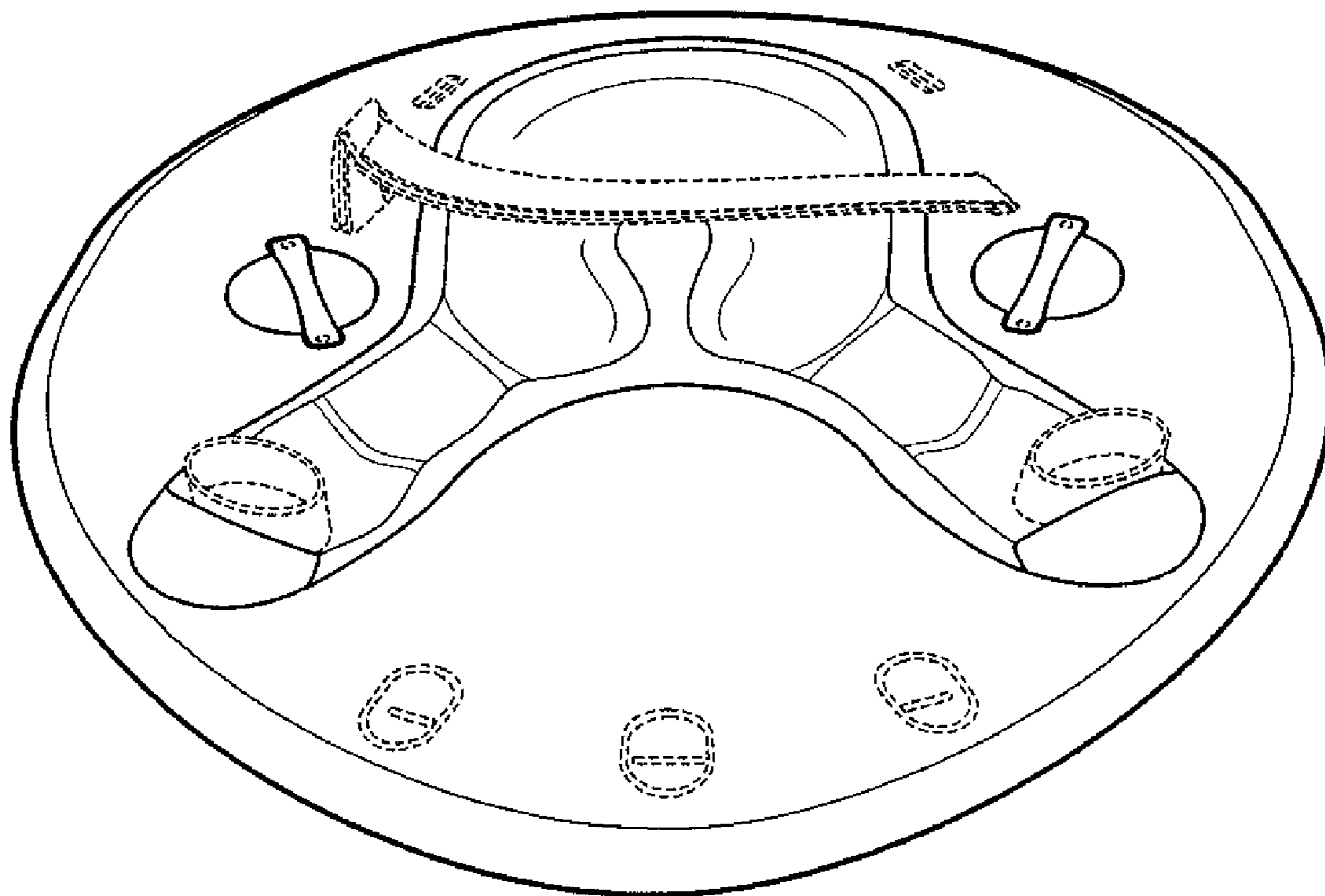

FIG. 24

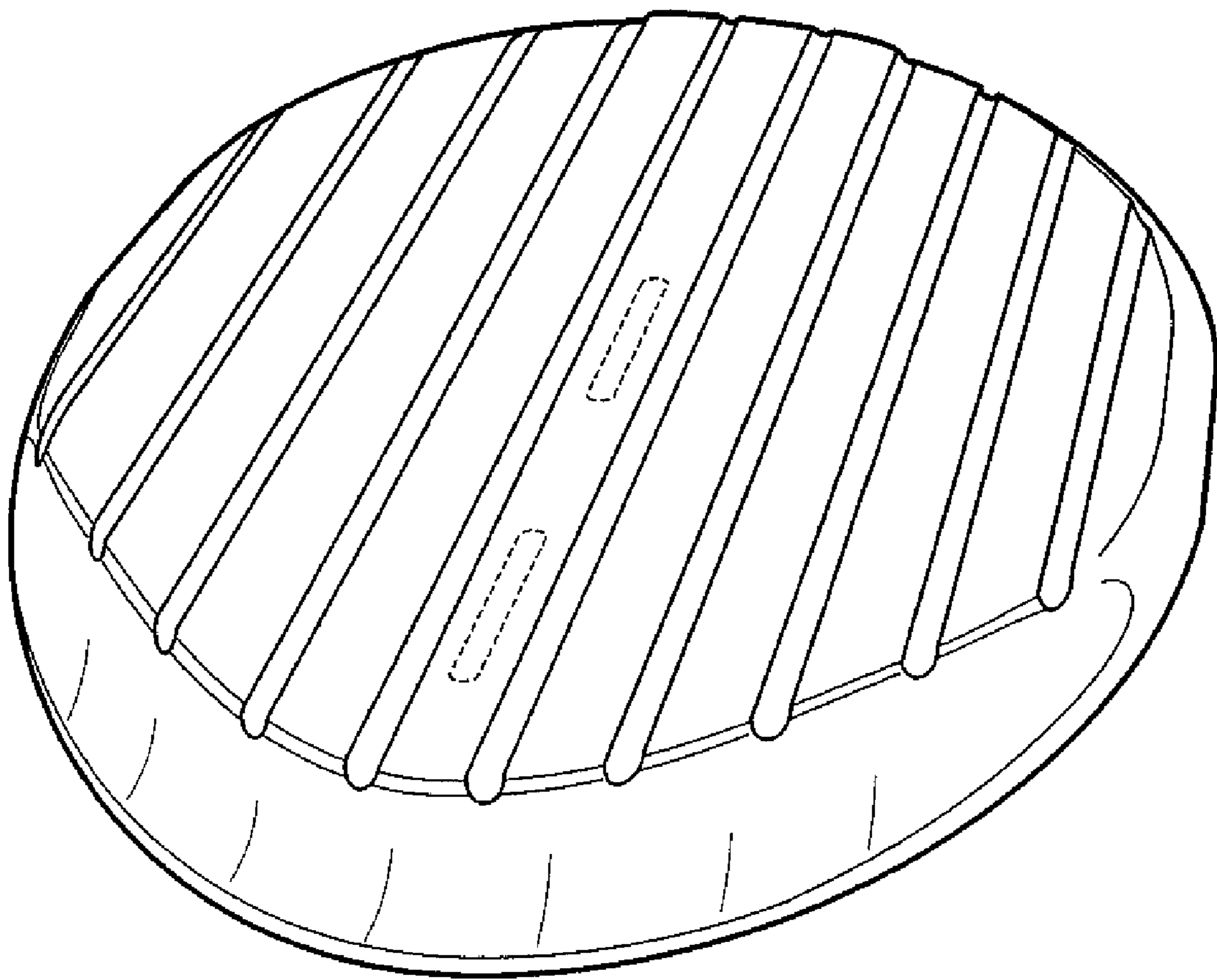

FIG. 25