

US00D562422S

(12) **United States Design Patent**
Roberts et al.

(10) **Patent No.:** **US D562,422 S**
(45) **Date of Patent:** **** Feb. 19, 2008**

(54) **BADGE UPON A SOLE PLATE OF A GOLF CLUB HEAD**

D526,374 S * 8/2006 Kawami D21/759
D547,815 S * 7/2007 Tang et al. D21/752
D550,800 S * 9/2007 Ruggiero et al. D21/759

(75) Inventors: **Clive Roberts**, Allendale, TX (US);
Cindy Herington, Plano, TX (US);
Derek Holiman, Plano, TX (US); **John Ruggiero**, McKinney, TX (US)

OTHER PUBLICATIONS

U.S. Trademark Appl. No. 75/627,646, Miscellaneous Design, filed Jan. 27, 1999.

(73) Assignee: **Adams Golf IP, L.P.**, Plano, TX (US)

* cited by examiner

(**) Term: **14 Years**

Primary Examiner—Mitchell Siegel

(21) Appl. No.: **29/268,736**

(74) *Attorney, Agent, or Firm*—Gallagher & Dawsey; David J. Dawsey; Michael J. Gallagher

(22) Filed: **Nov. 13, 2006**

(57) **CLAIM**

(51) **LOC (8) Cl.** **21-02**

The ornamental design for a badge upon a sole plate of a golf club head, as shown and described.

(52) **U.S. Cl.** **D21/759**

(58) **Field of Classification Search** D21/733,

D21/752, 759; 473/324–331, 343–346

See application file for complete search history.

DESCRIPTION

(56) **References Cited**

FIG. 1 is a perspective view from the heel of the sole plate of a golf club head showing my new design.

FIG. 2 is a perspective view from the toe thereof.

FIG. 3 is a bottom view thereof.

FIG. 4 is a rear plan view thereof.

FIG. 5 is a perspective view from the heel of the sole plate of a golf club head showing my new design.

FIG. 6 is a perspective view from the toe thereof.

FIG. 7 is a bottom view thereof; and,

FIG. 8 is a rear plan view thereof.

The broken lines in the drawings are for the purpose of showing environmental structure and do not form a part of the design to be patented.

U.S. PATENT DOCUMENTS

- D365,129 S * 12/1995 Guibaud et al. D21/752
- 5,547,188 A * 8/1996 Dumontier et al. 473/287
- D398,681 S * 9/1998 Galy D21/733
- D433,073 S * 10/2000 Sodano D21/752
- D453,203 S 1/2002 Madore et al.
- 6,364,788 B1 4/2002 Helmstetter et al.
- D470,903 S 2/2003 Evans et al.
- D491,244 S 6/2004 Tang
- D502,976 S * 3/2005 Nishitani et al. D21/752
- D503,956 S * 4/2005 Kono D21/759
- D506,236 S * 6/2005 Evans et al. D21/752
- D507,321 S 7/2005 Dogan et al.
- D516,651 S * 3/2006 Evans et al. D21/752
- D524,890 S * 7/2006 Foster et al. D21/752

1 Claim, 4 Drawing Sheets

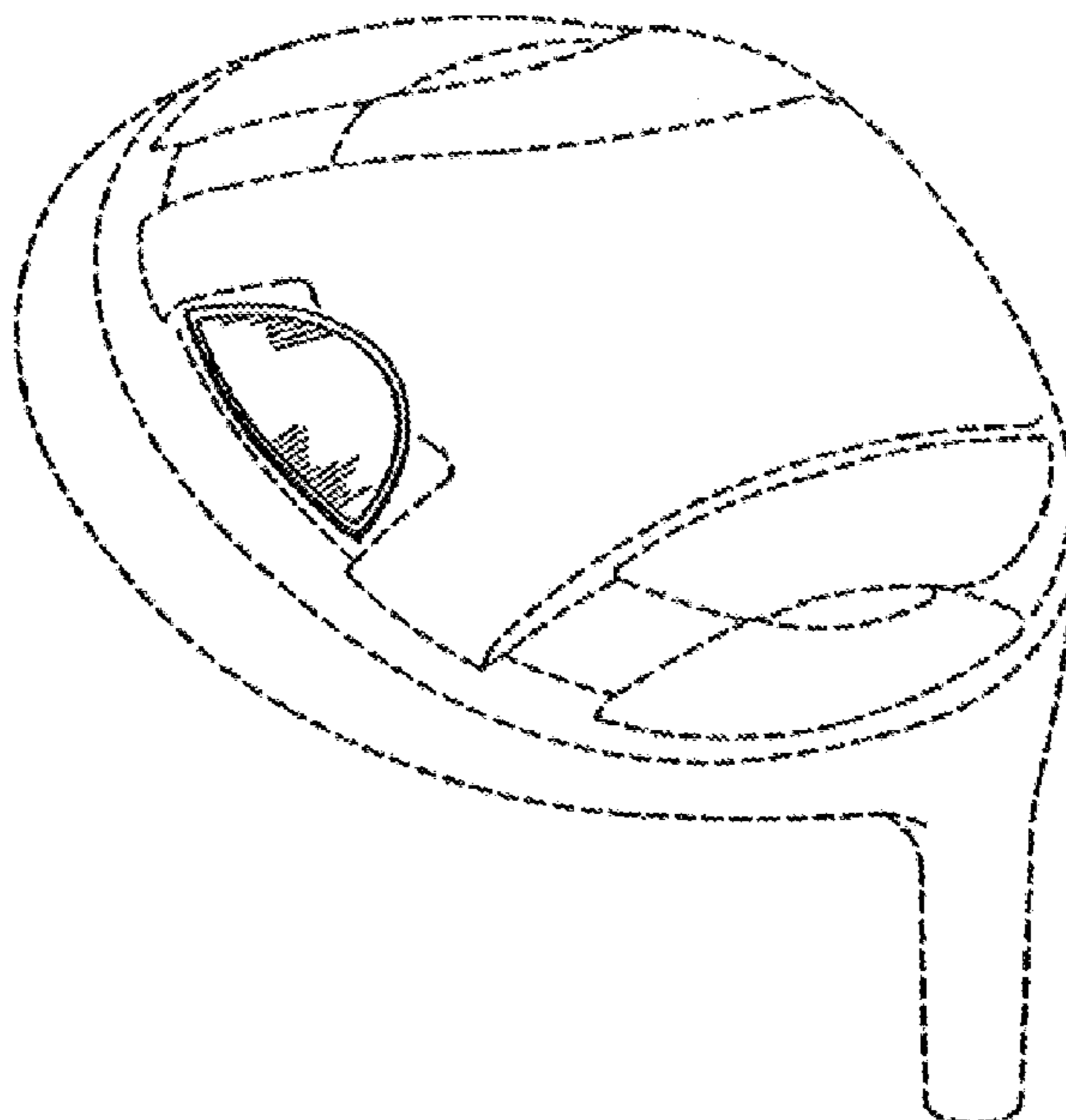

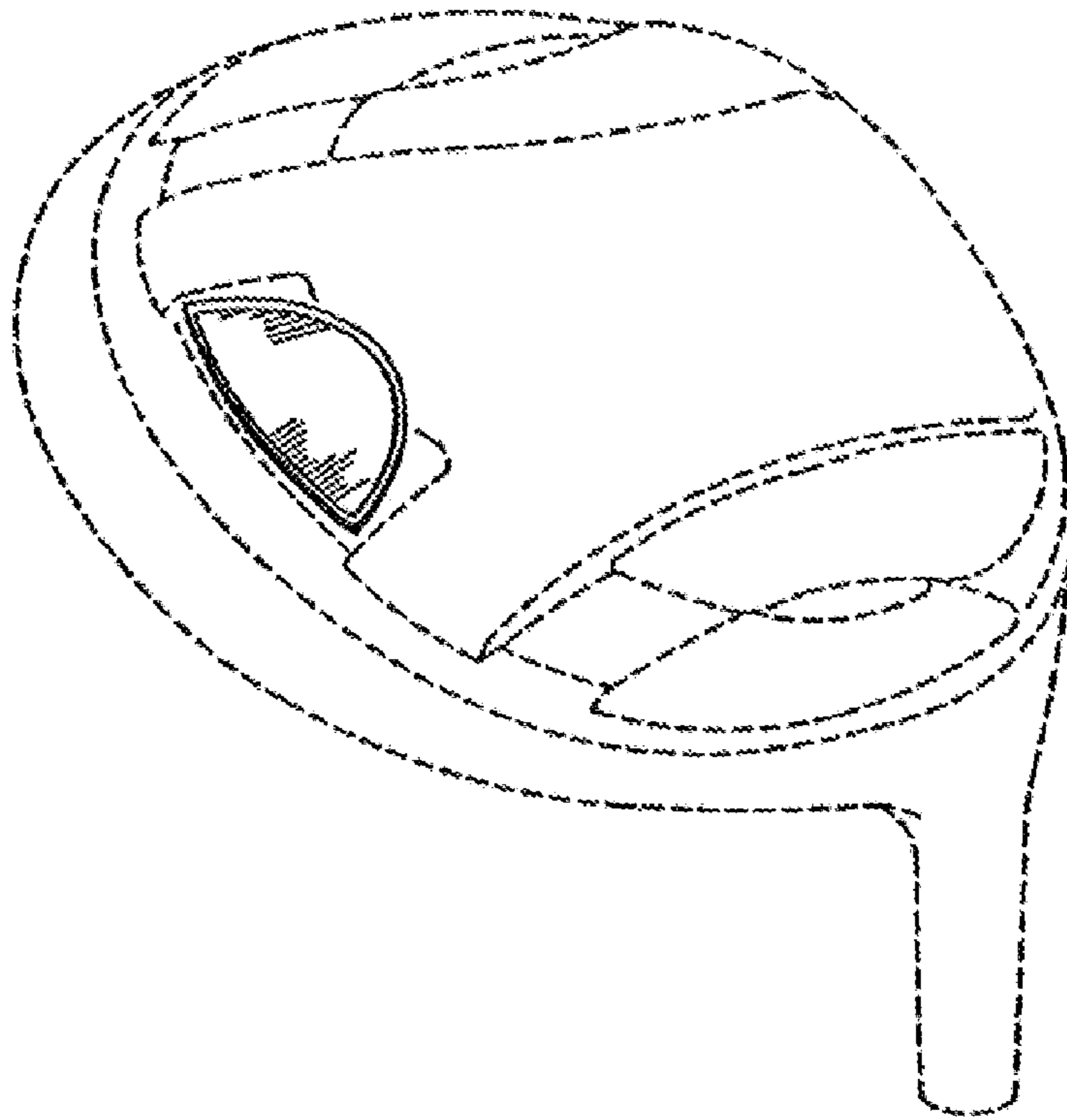

FIG. 1

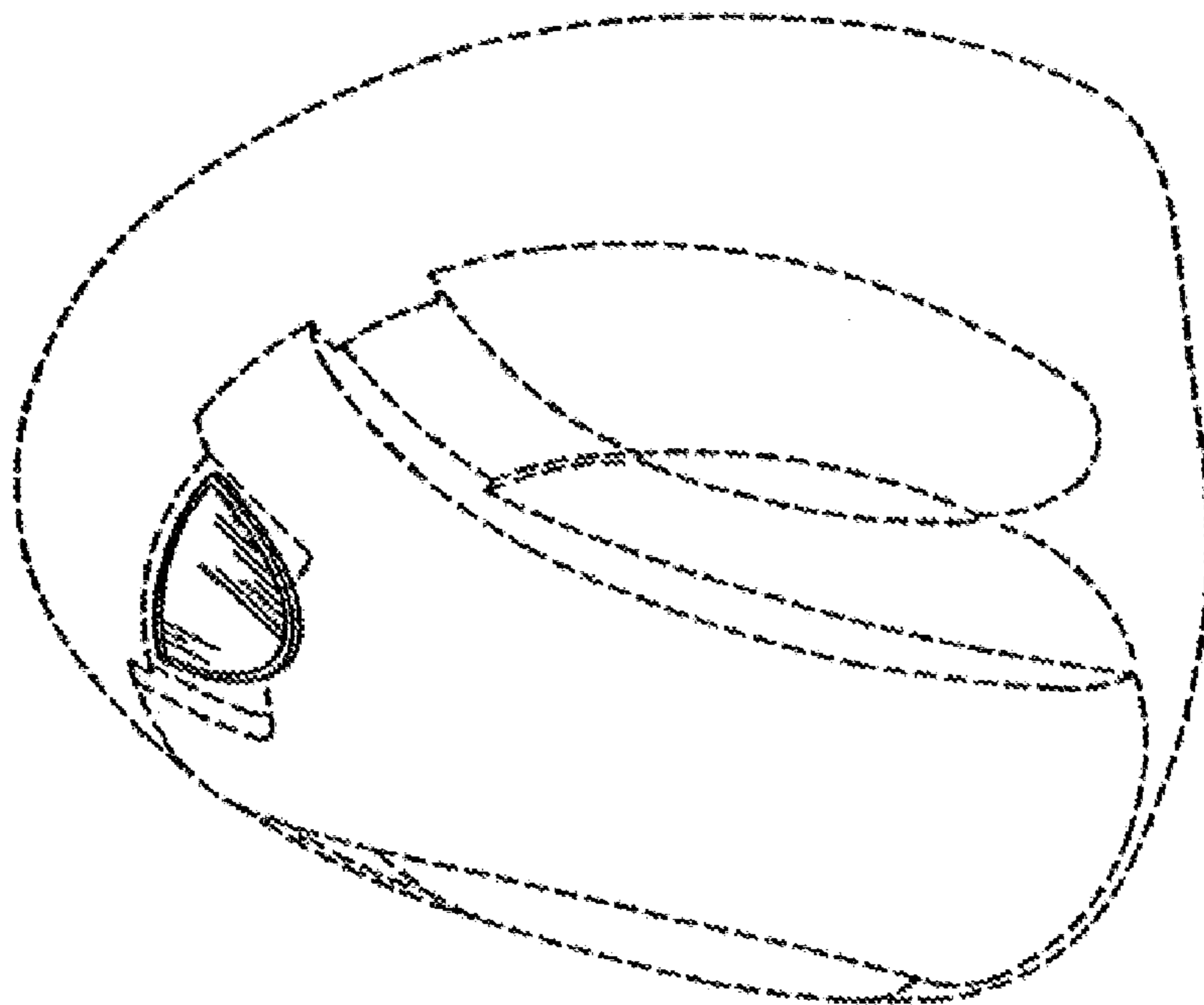

FIG. 2

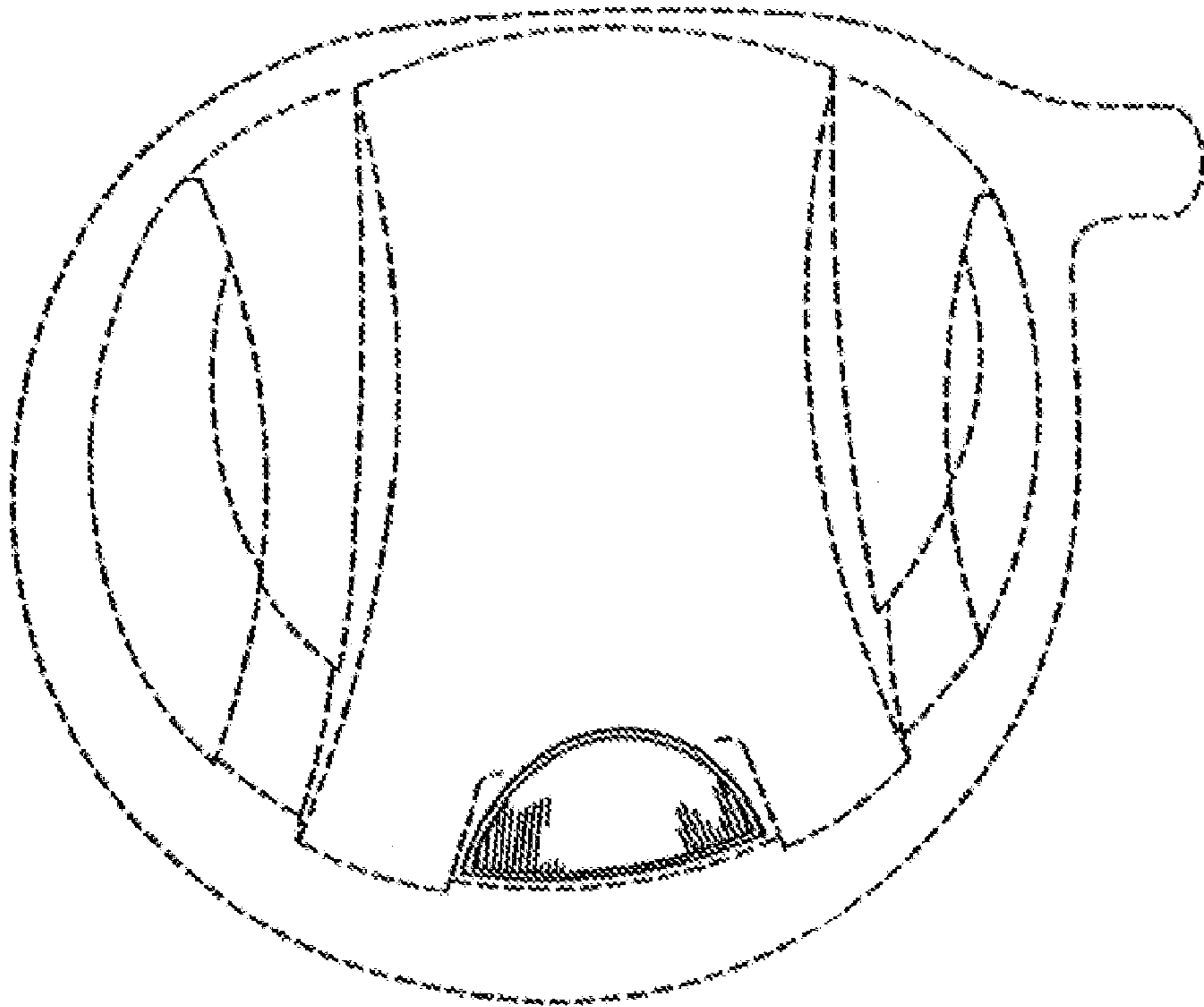

FIG. 3

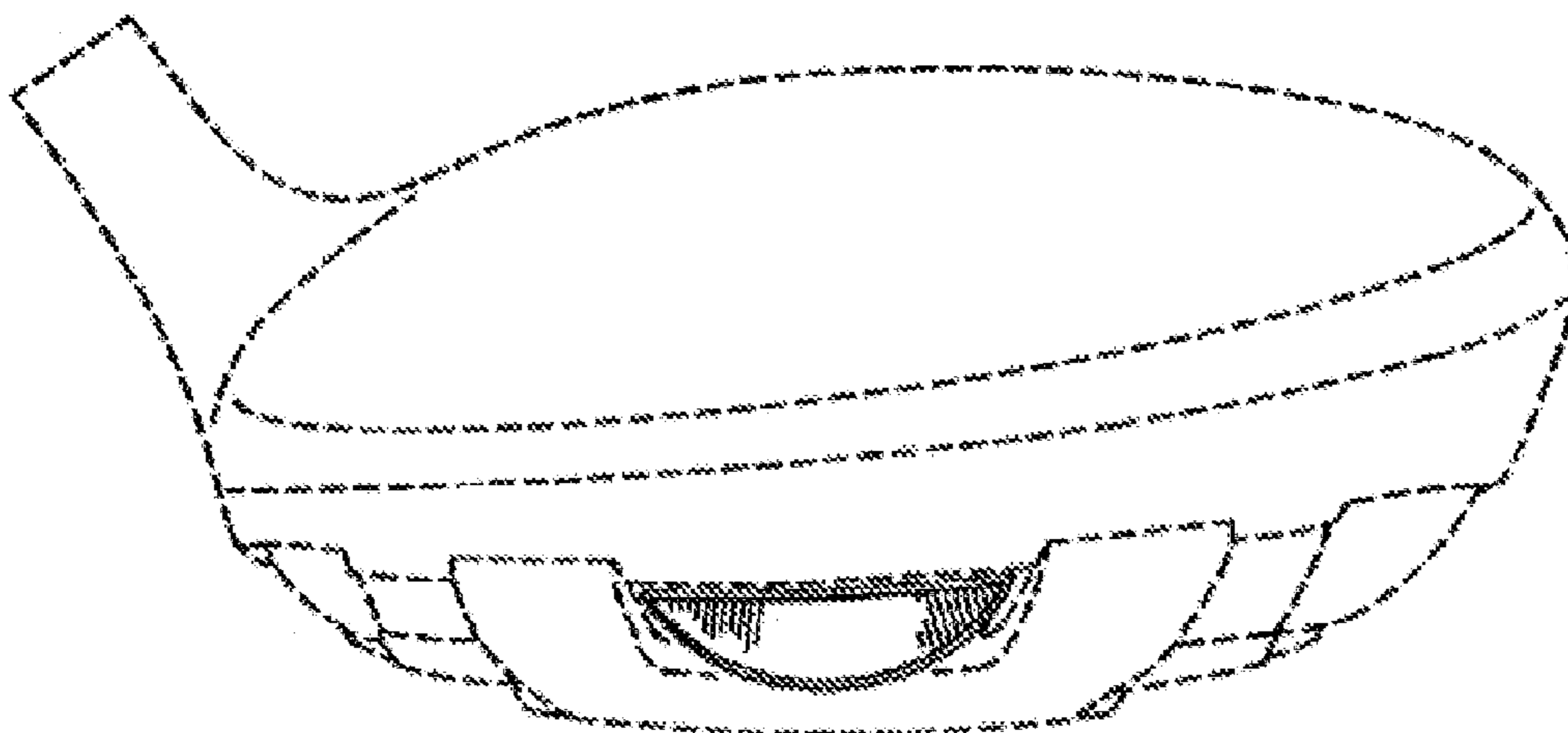

FIG. 4

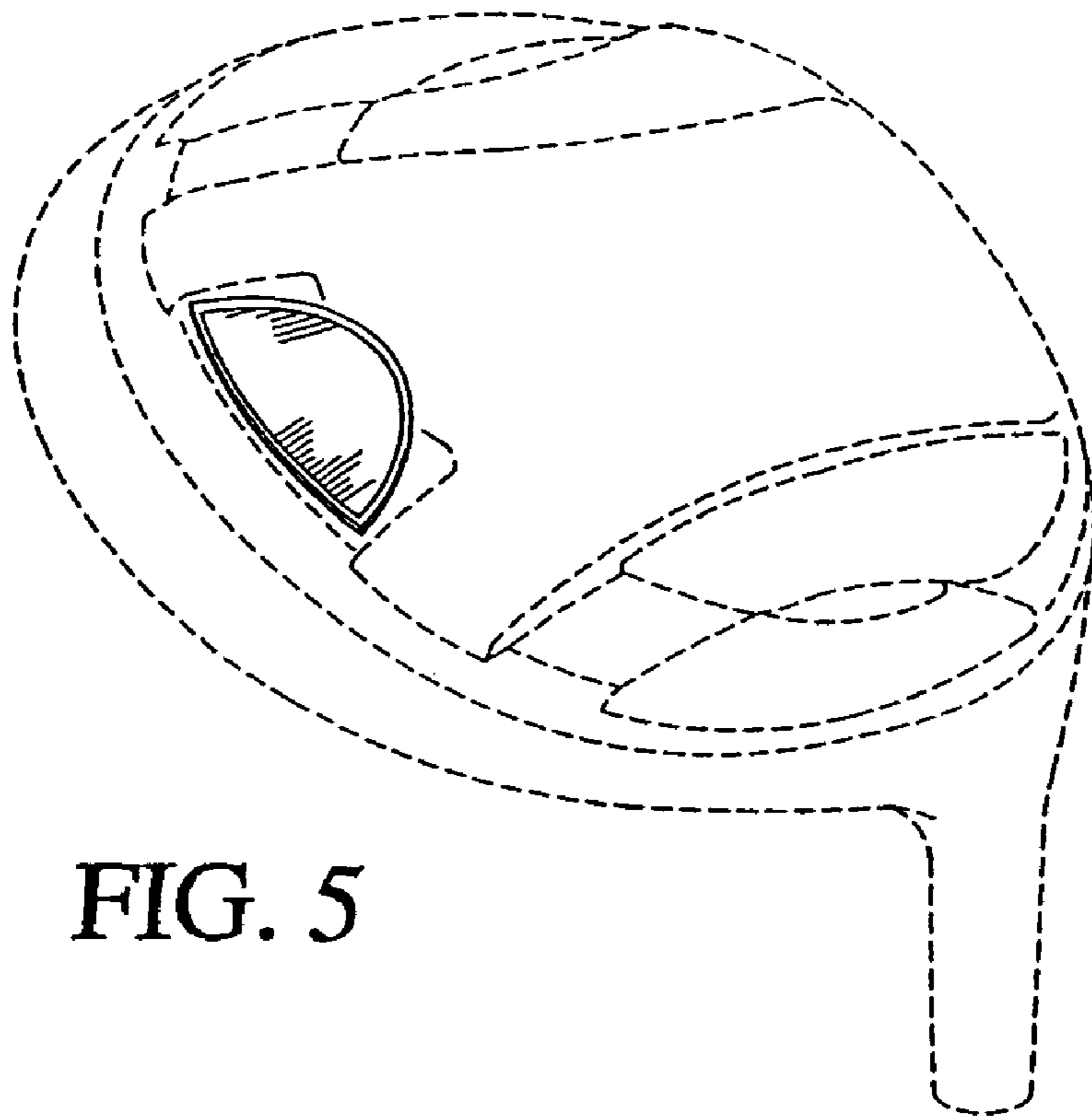

FIG. 5

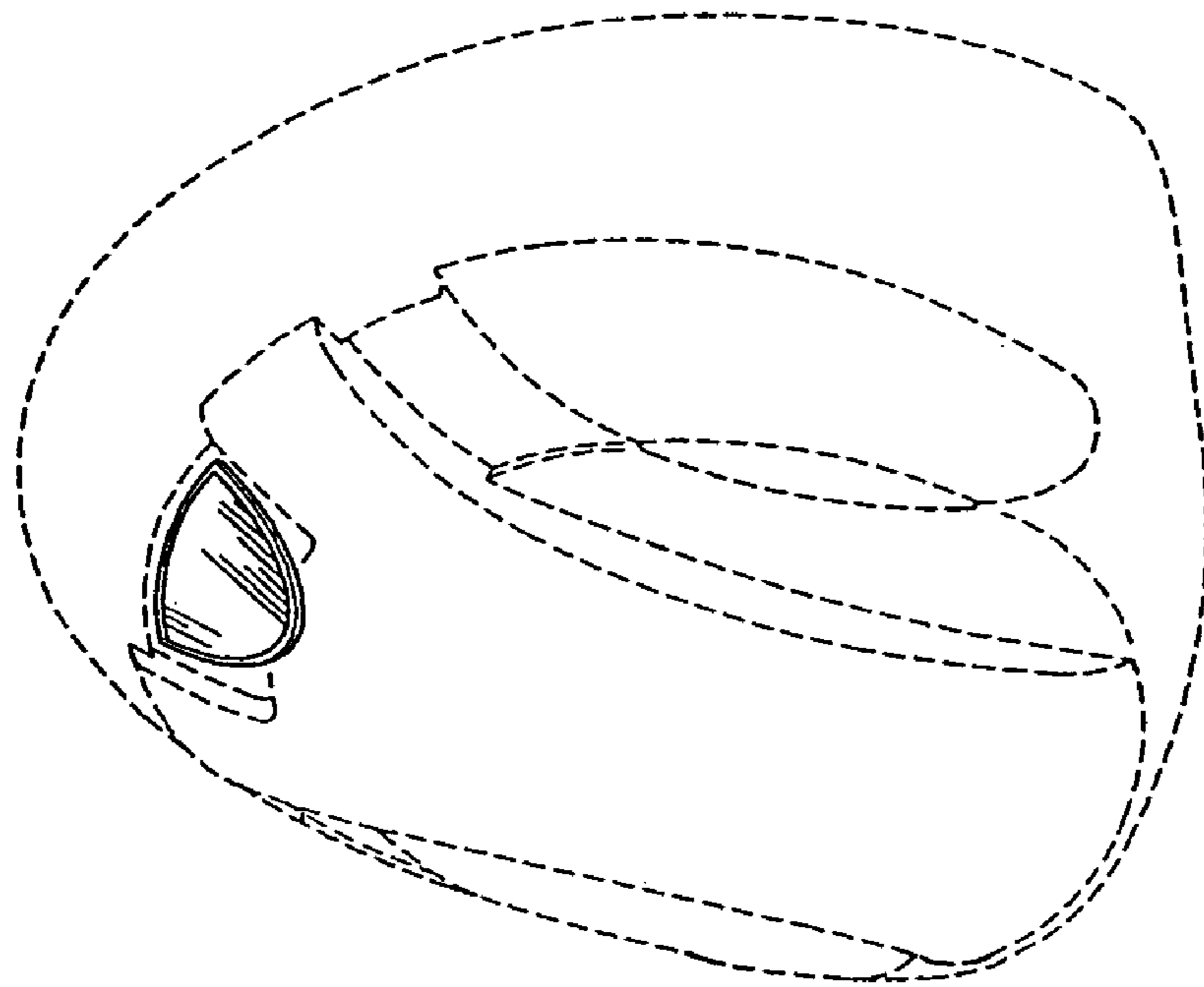

FIG. 6

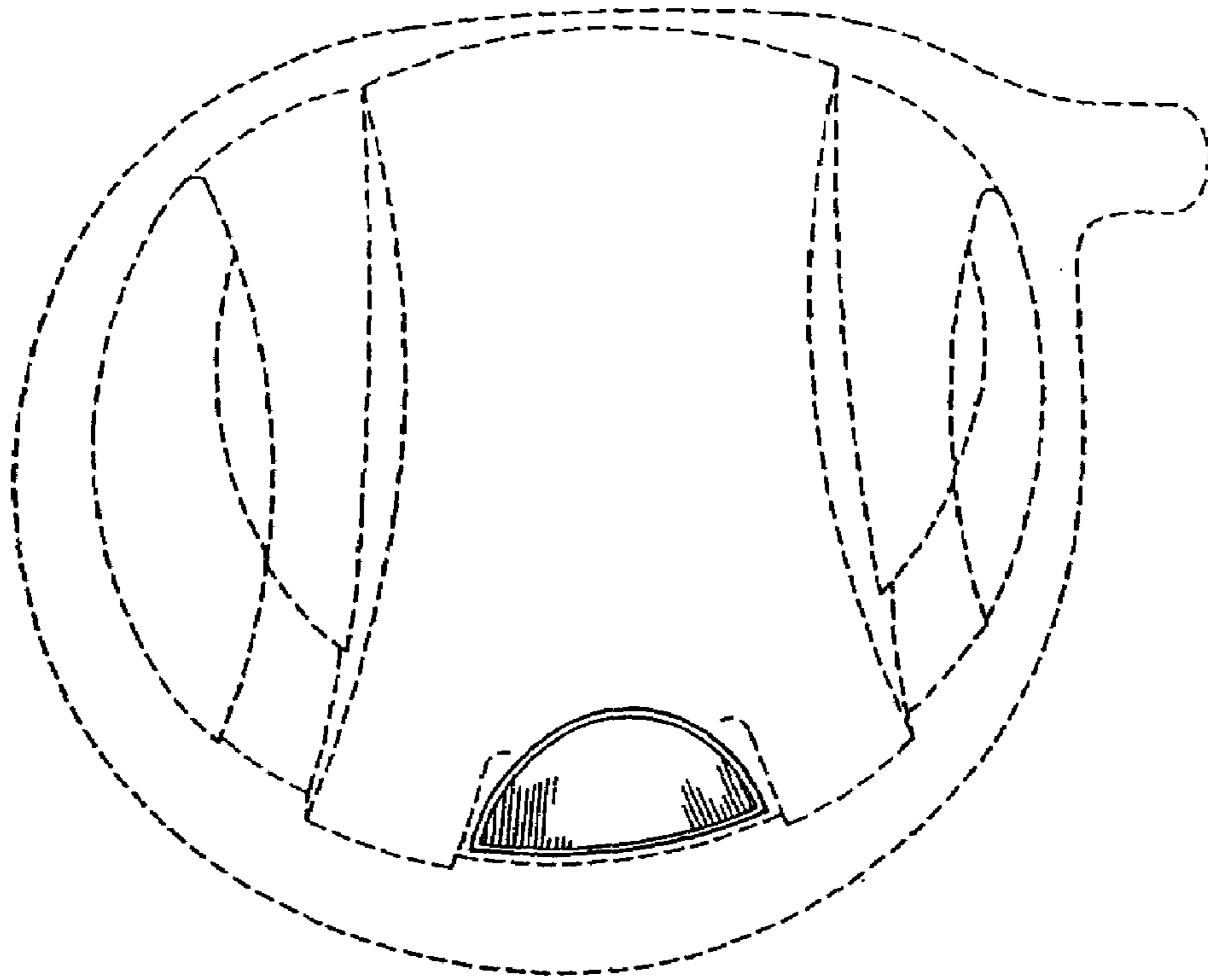

FIG. 7

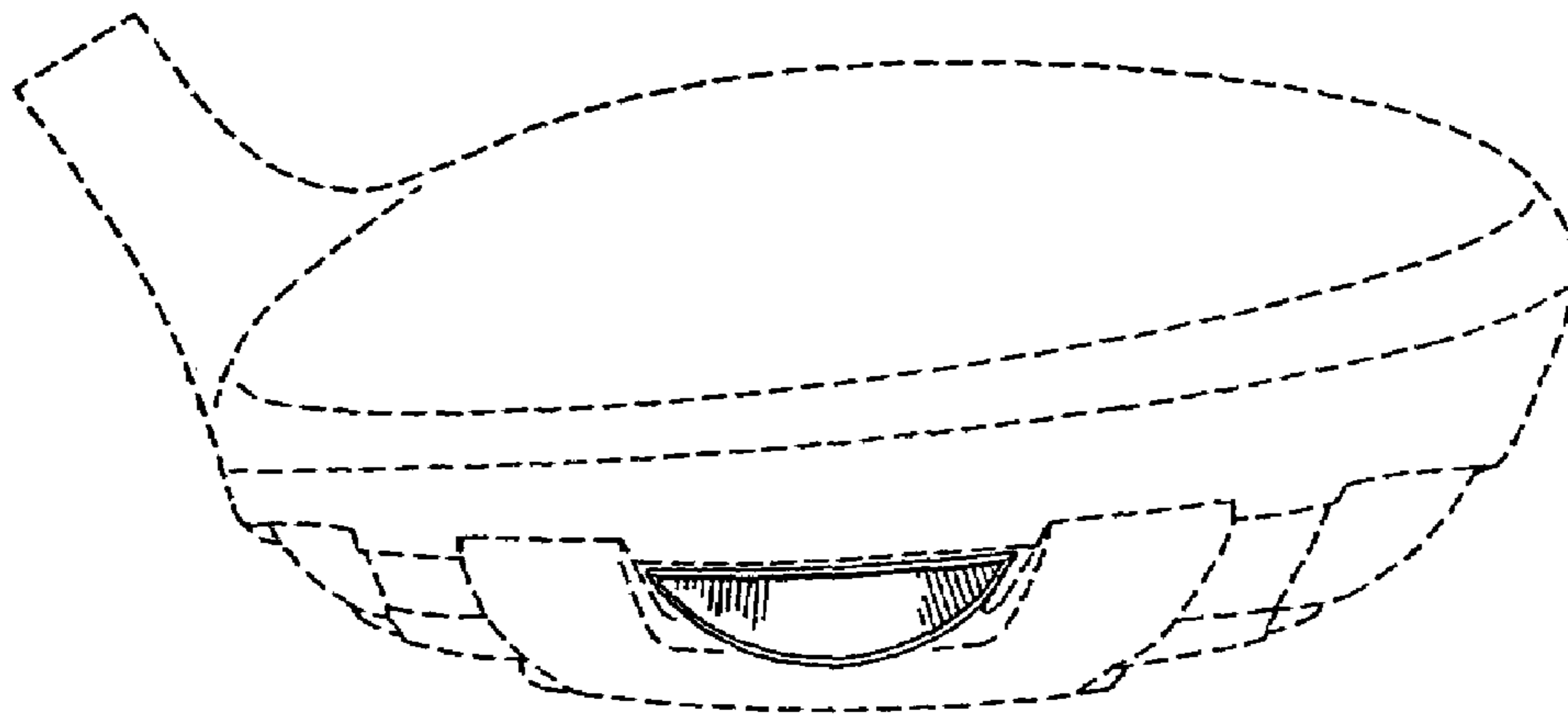

FIG. 8