

US00D562352S

(12) **United States Design Patent**  
**Matsuzaki et al.**

(10) **Patent No.:** **US D562,352 S**

(45) **Date of Patent:** **\*\* Feb. 19, 2008**

(54) **HANDRAIL FOR A TRACTOR**

(75) Inventors: **Akihiro Matsuzaki**, Osaka (JP);  
**Atsushi Hayashi**, Osaka (JP)

(73) Assignee: **Kubota Corporation**, Osaka-Shi (JP)

(\*\*) Term: **14 Years**

(21) Appl. No.: **29/260,576**

(22) Filed: **May 30, 2006**

(30) **Foreign Application Priority Data**

Nov. 30, 2005 (JP) ..... 2005-035396

(51) **LOC (8) Cl.** ..... **15-03**

(52) **U.S. Cl.** ..... **D15/28**

(58) **Field of Classification Search** ..... D15/17,  
D15/18, 28; D12/414, 23; D25/38; 296/71;  
280/163, 760; 182/127

See application file for complete search history.

(56) **References Cited**

U.S. PATENT DOCUMENTS

3,588,136	A *	6/1971	Schlueter	.....	280/834
D238,602	S *	1/1976	Saele et al.	.....	D15/28
4,240,648	A *	12/1980	Starr	.....	280/760
4,416,486	A *	11/1983	McNaught et al.	....	296/190.11
D274,062	S *	5/1984	Hansen	.....	D15/27
4,480,845	A *	11/1984	Hansen	.....	280/834
4,976,455	A *	12/1990	Brammer et al.	.....	280/762
D367,314	S *	2/1996	Nilsson	.....	D23/200
6,029,775	A *	2/2000	Hedley et al.	.....	182/127
D463,805	S *	10/2002	Witte et al.	.....	D15/23
D509,905	S *	9/2005	Baker	.....	D25/38
D513,268	S *	12/2005	Wang et al.	.....	D15/23
6,971,657	B2 *	12/2005	King et al.	.....	280/163

7,007,366	B1 *	3/2006	Eby	.....	29/436
2003/0230904	A1 *	12/2003	Brockway	.....	293/102
2004/0178602	A1 *	9/2004	King et al.	.....	280/163
2005/0067610	A1 *	3/2005	Marshall et al.	.....	256/65.16
2005/0130805	A1 *	6/2005	Phipps	.....	482/35
2006/0000654	A1 *	1/2006	Ricke et al.	.....	180/89.12

\* cited by examiner

*Primary Examiner*—Stella M. Reid

*Assistant Examiner*—Mark Goodwin

(74) *Attorney, Agent, or Firm*—Birch, Stewart, Kolasch & Birch, LLP

(57) **CLAIM**

The ornamental design for handrail for a tractor, as shown and described.

**DESCRIPTION**

FIG. 1 is a front view of a handrail for a tractor showing my new design;

FIG. 2 is a rear view thereof;

FIG. 3 is a top plan view thereof;

FIG. 4 is a bottom plan view thereof;

FIG. 5 is an enlarged left side view thereof;

FIG. 6 is an enlarged right side view thereof;

FIG. 7 is a side view illustrating the design attached to a tractor; and,

FIG. 8 is a front view illustrating the design attached to a tractor.

The broken lines shown in FIGS. 1–8 are for the purpose of showing environmental structure only and form no part of the claimed design.

**1 Claim, 8 Drawing Sheets**

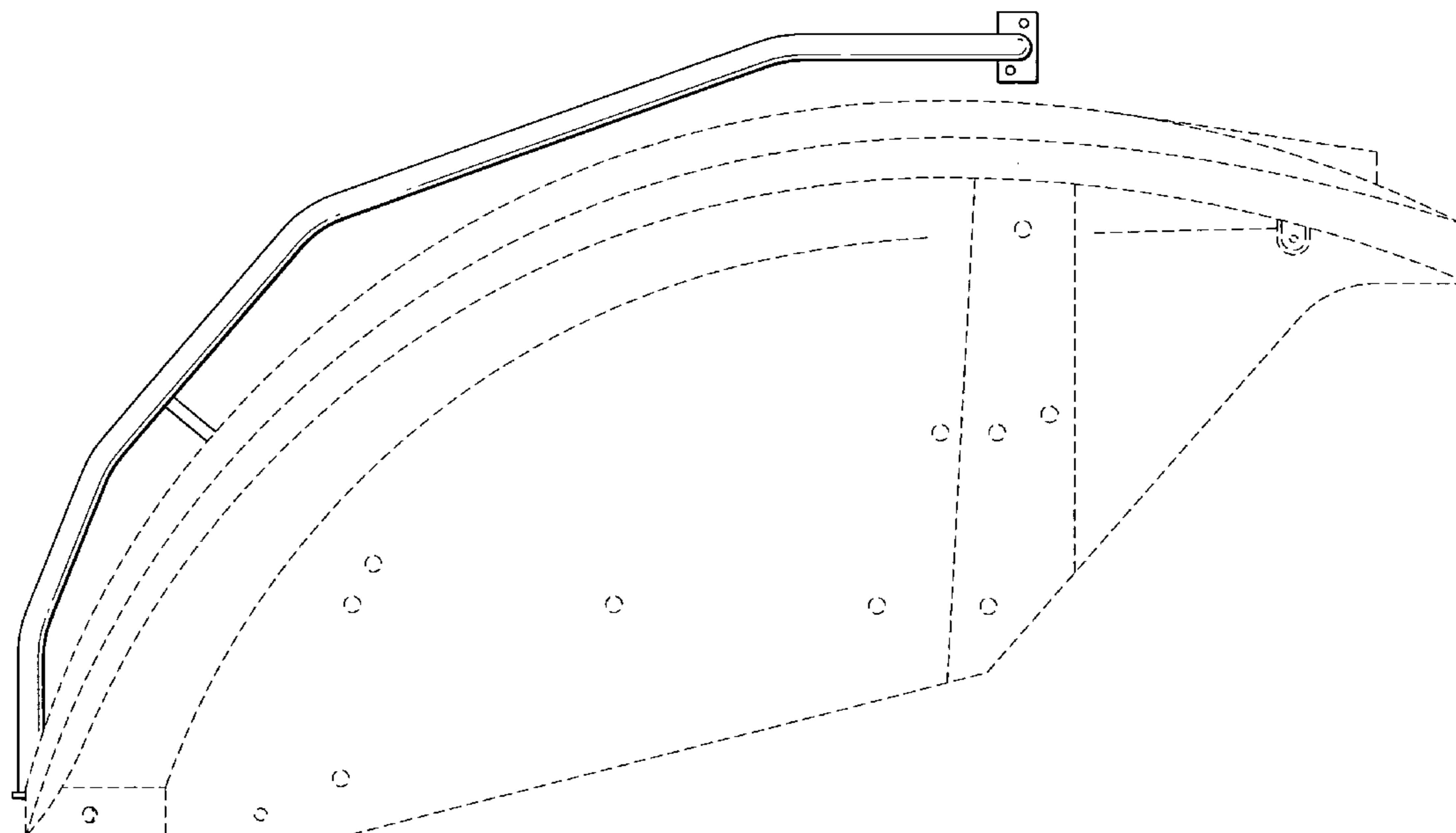

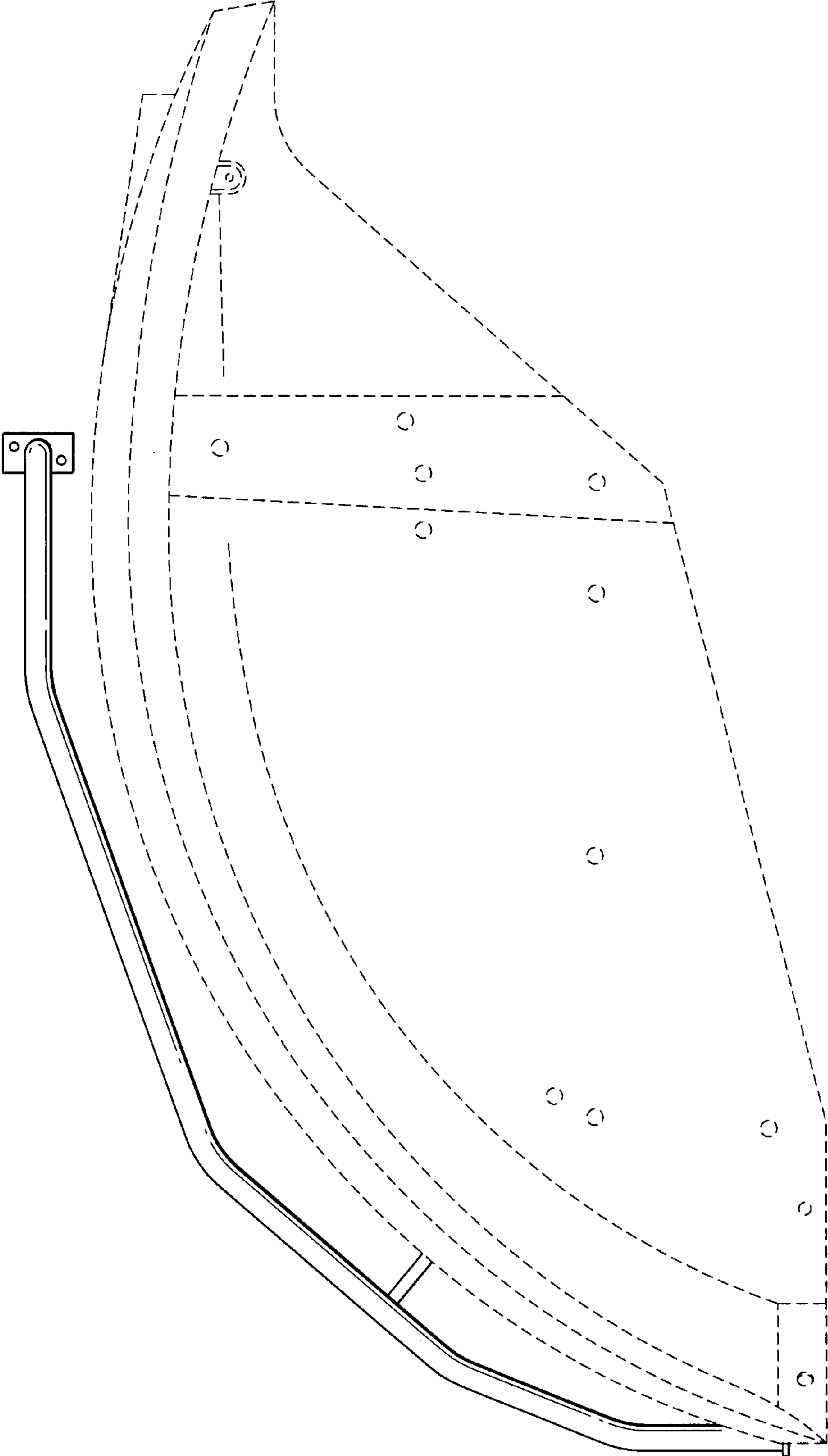

FIG.1

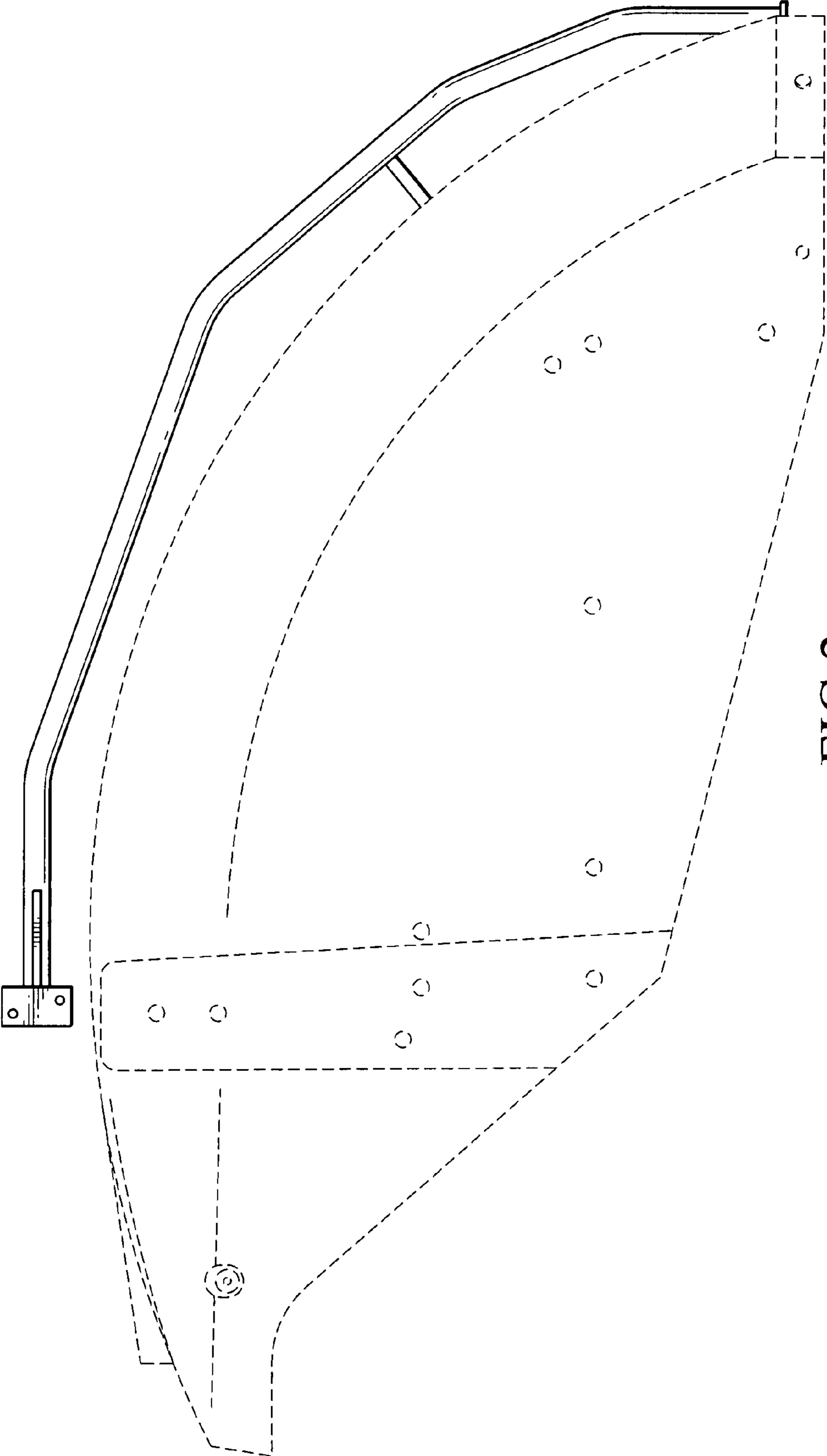

FIG.2

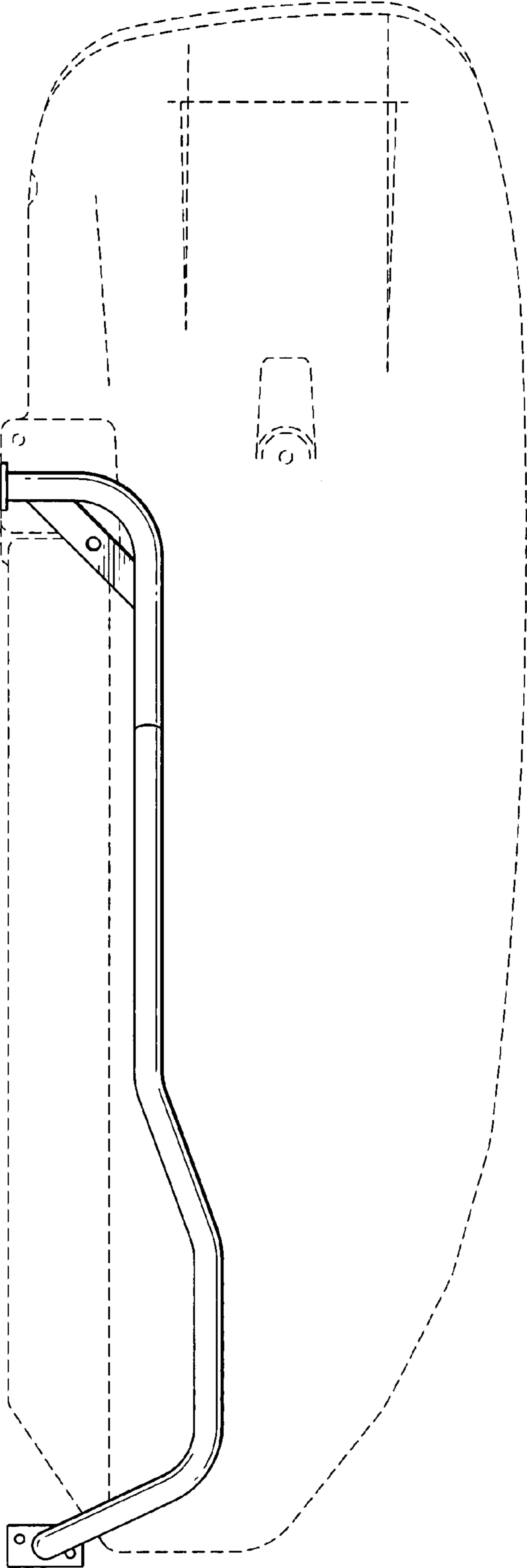

FIG.3

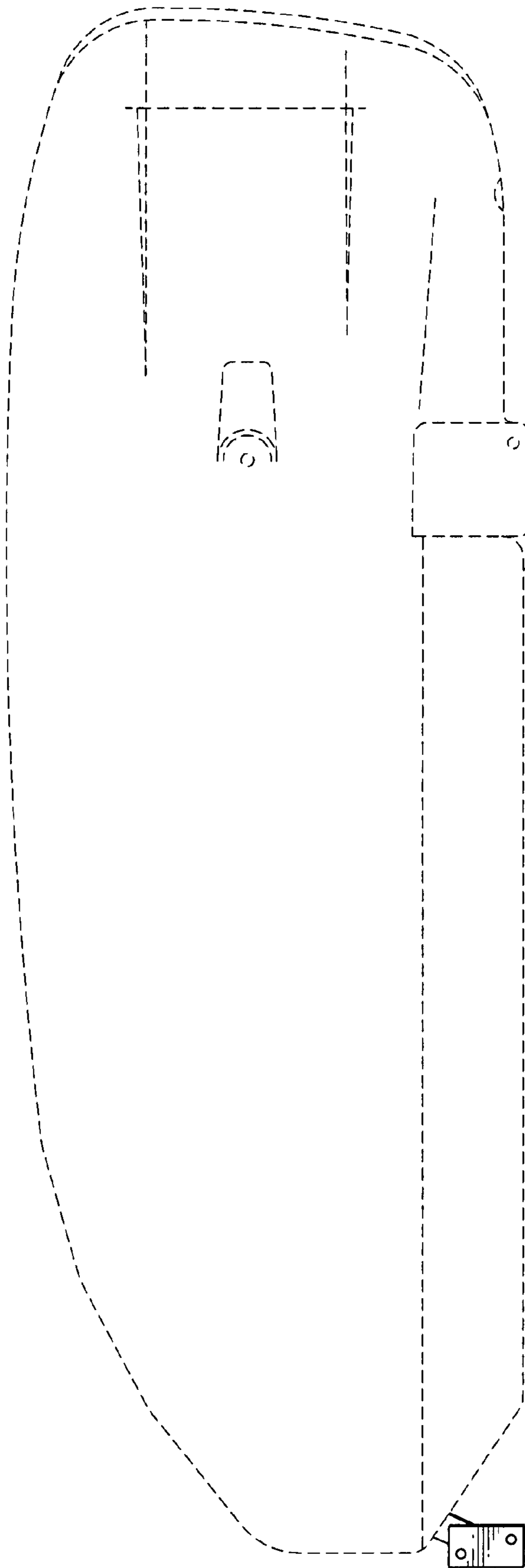

FIG. 4

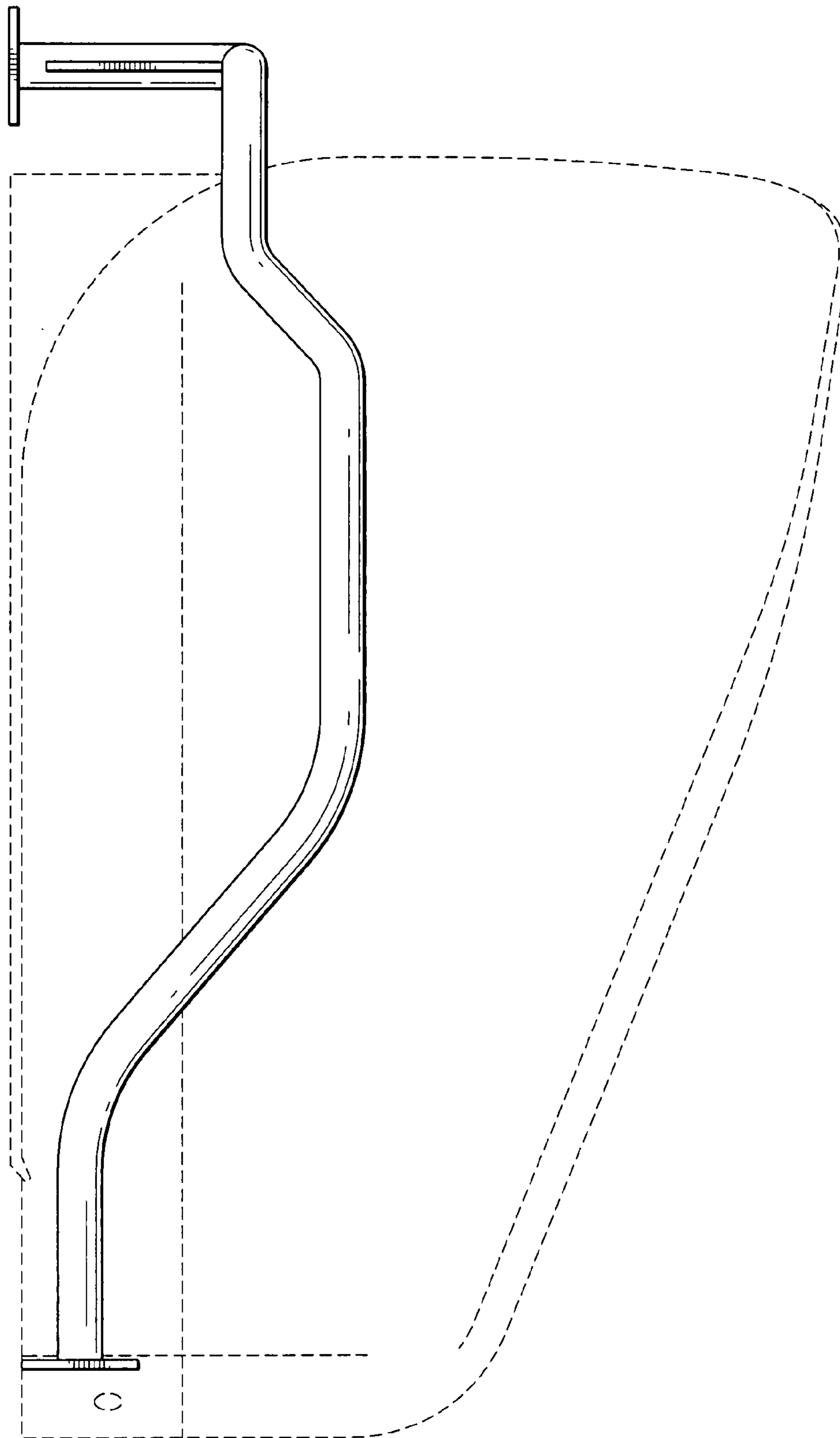

FIG.5

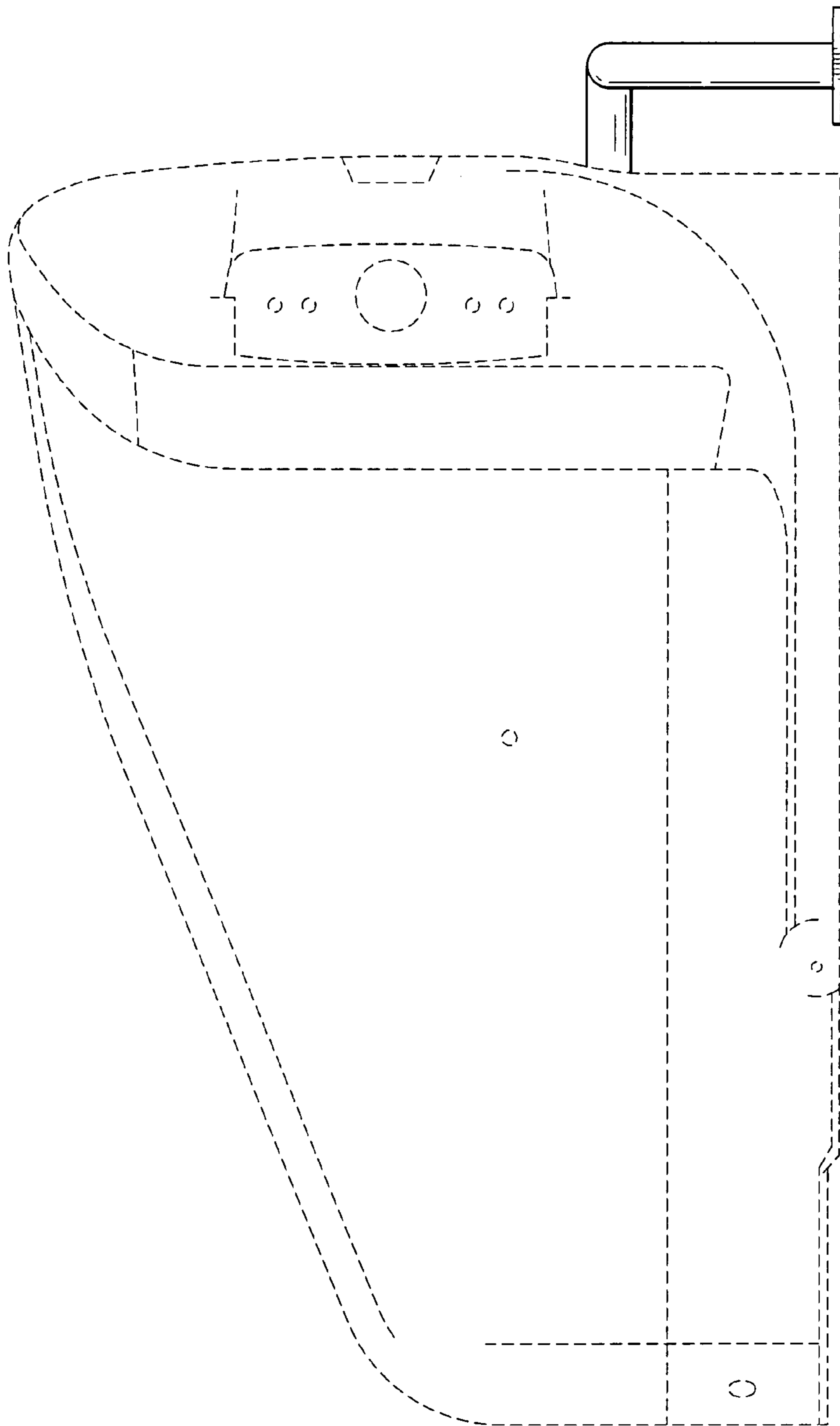
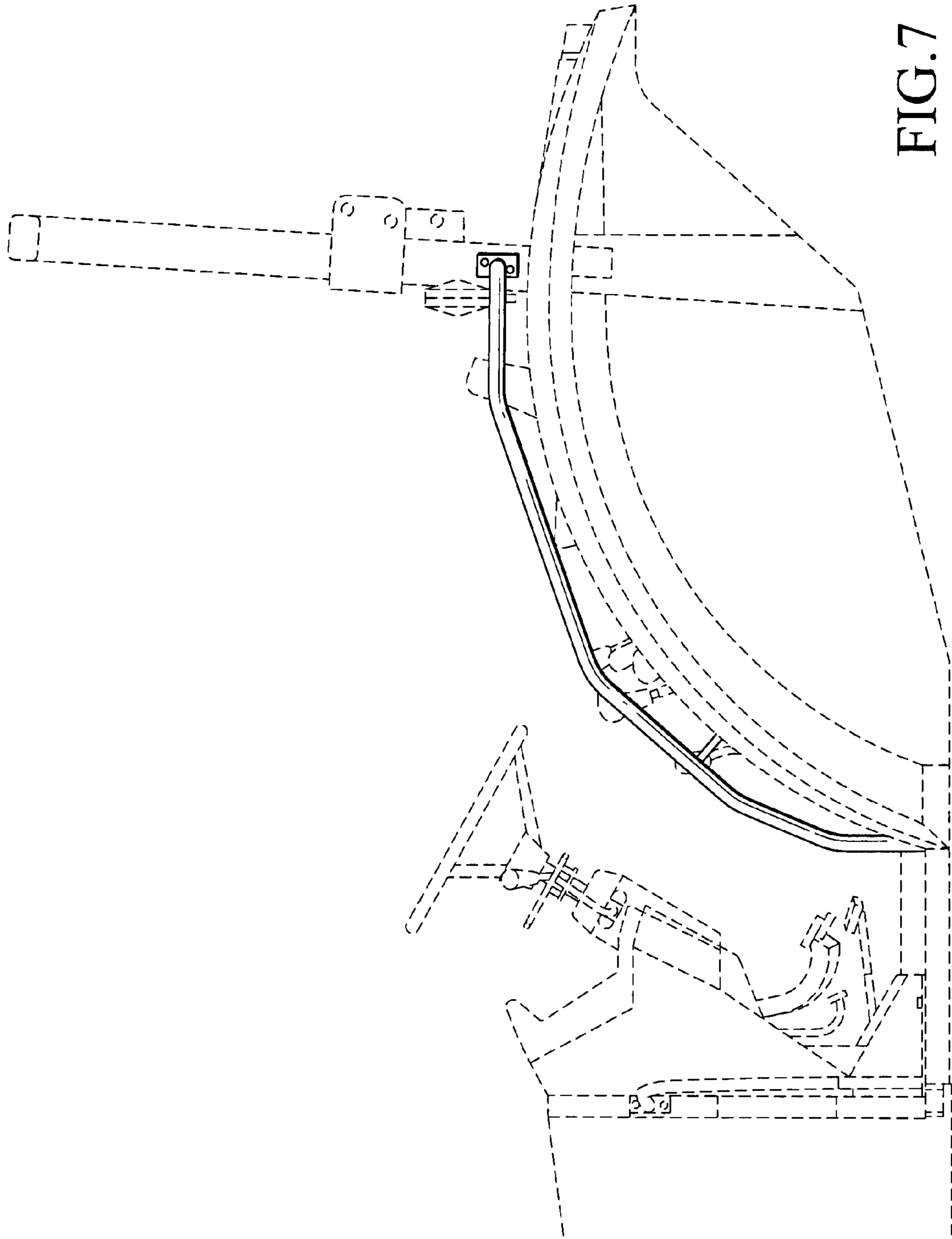

FIG. 6





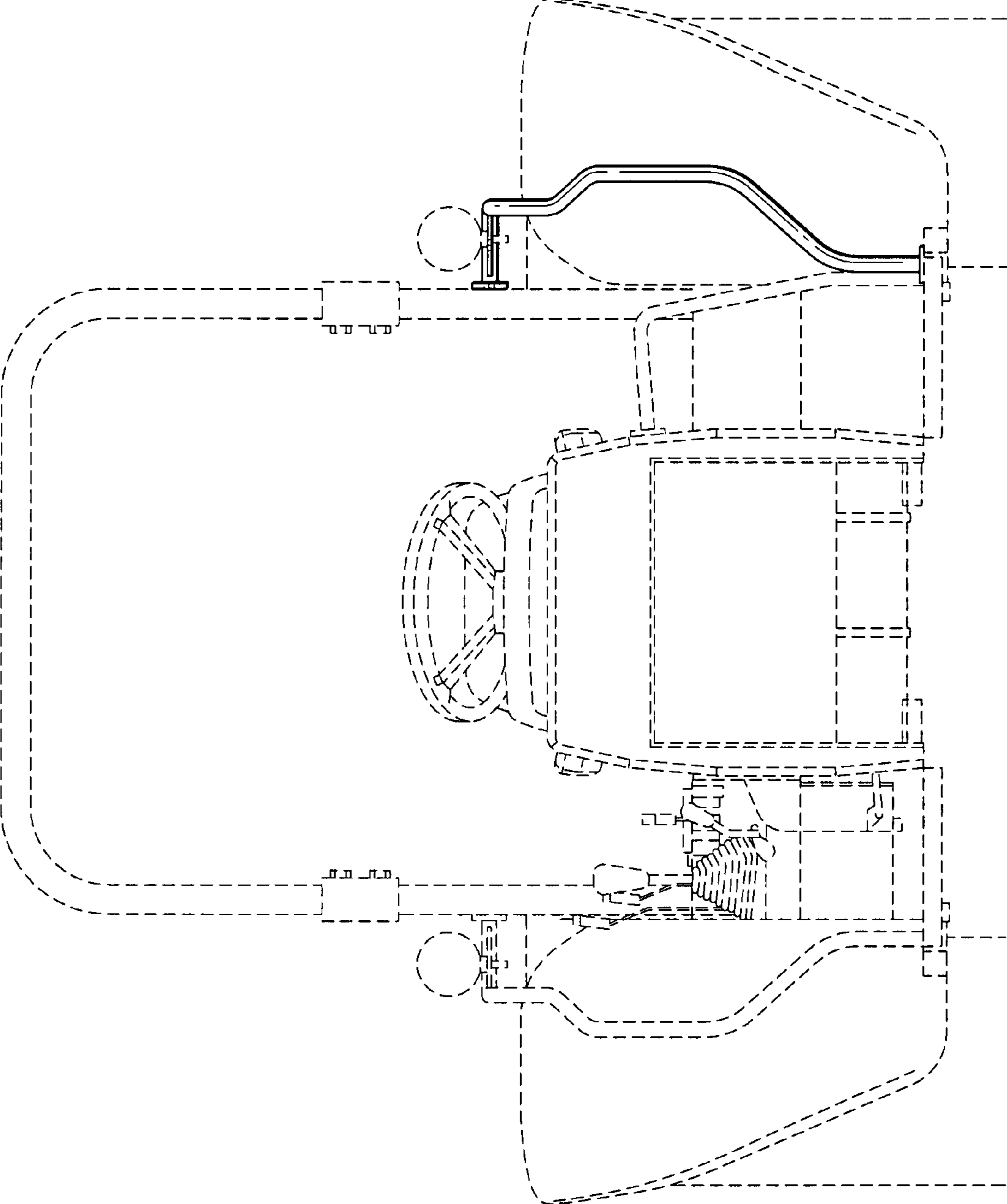

FIG.8