



US00D562313S

(12) **United States Design Patent** (10) **Patent No.:** **US D562,313 S**  
**Tan et al.** (45) **Date of Patent:** **\*\* Feb. 19, 2008**

(54) **HOUSING FOR A COMMUNICATION DEVICE**

(75) Inventors: **Kok Keong Raymond Tan**, Singapore (SG); **Ignacio Germade**, Oxford (GB); **Bee Lay Khoo**, Singapore (SG)

(73) Assignee: **Motorola, Inc.**, Schaumburg, IL (US)

(\*\*) Term: **14 Years**

(21) Appl. No.: **29/277,979**

(22) Filed: **Mar. 15, 2007**

(51) **LOC (8) Cl.** ..... **14-03**

(52) **U.S. Cl.** ..... **D14/248; D14/138**

(58) **Field of Classification Search** ..... D14/137-138, D14/147-148, 156, 218, 247-248, 341-347, D14/496; D16/208; D21/329, 331, 333, D21/517; 348/14.01-14.02; 361/814; 379/433.01-433.13; 455/90.3, 556.1-556.2, 455/566, 575.1, 575.3, 575.4

See application file for complete search history.

(56) **References Cited**

**U.S. PATENT DOCUMENTS**

D401,929	S	*	12/1998	Lucaci et al.	.....	D14/138
D503,163	S	*	3/2005	Chan et al.	.....	D14/138
D514,079	S	*	1/2006	Lai	.....	D14/138
D515,543	S	*	2/2006	Shintani	.....	D14/138
D517,518	S	*	3/2006	Nakajima et al.	.....	D14/138
D525,228	S	*	7/2006	Kim et al.	.....	D14/138
D545,800	S	*	7/2007	Ou et al.	.....	D14/138
D546,316	S	*	7/2007	Wu et al.	.....	D14/138
D546,801	S	*	7/2007	Jung	.....	D14/138
D548,216	S	*	8/2007	Pan et al.	.....	D14/138
D549,677	S	*	8/2007	Fahlgren	.....	D14/138
D549,683	S	*	8/2007	Cho et al.	.....	D14/138
2005/0054397	A1	*	3/2005	Kim et al.	.....	455/575.4

**OTHER PUBLICATIONS**

Motorola C980, announced 3Q 2004, <URL:http://www.gsmarena.com/motorola\_c980-897.php>, retrieved from internet on Aug. 29, 2007.\*

LG L341i, announced 2Q 2005, <URL:http://www.gsmarena.com/lg\_l341i-1194.php>, retrieved from internet on Aug. 29, 2007.\*

i-mate SP5, announced Aug. 2005, <URL:http://www.gsmarena.com/i\_mate\_sp5-1267.php>, retrieved from internet on Aug. 29, 2007.\*

Nokia 6708, announced 1Q 2005, <URL:http://www.gsmarena.com/nokia\_6708-1518.php>, retrieved from internet on Aug. 29, 2007.\*

\* cited by examiner

*Primary Examiner*—Ian Simmons

*Assistant Examiner*—Carla Jobe Wright

(74) *Attorney, Agent, or Firm*—David S. Noskowicz

(57) **CLAIM**

The ornamental design for a housing for a communication device, as shown and described.

**DESCRIPTION**

FIG. 1 is a perspective view of a housing for a communication device showing our new design.

FIG. 2 is a front view thereof.

FIG. 3 is a rear view thereof.

FIG. 4 is a first side view thereof.

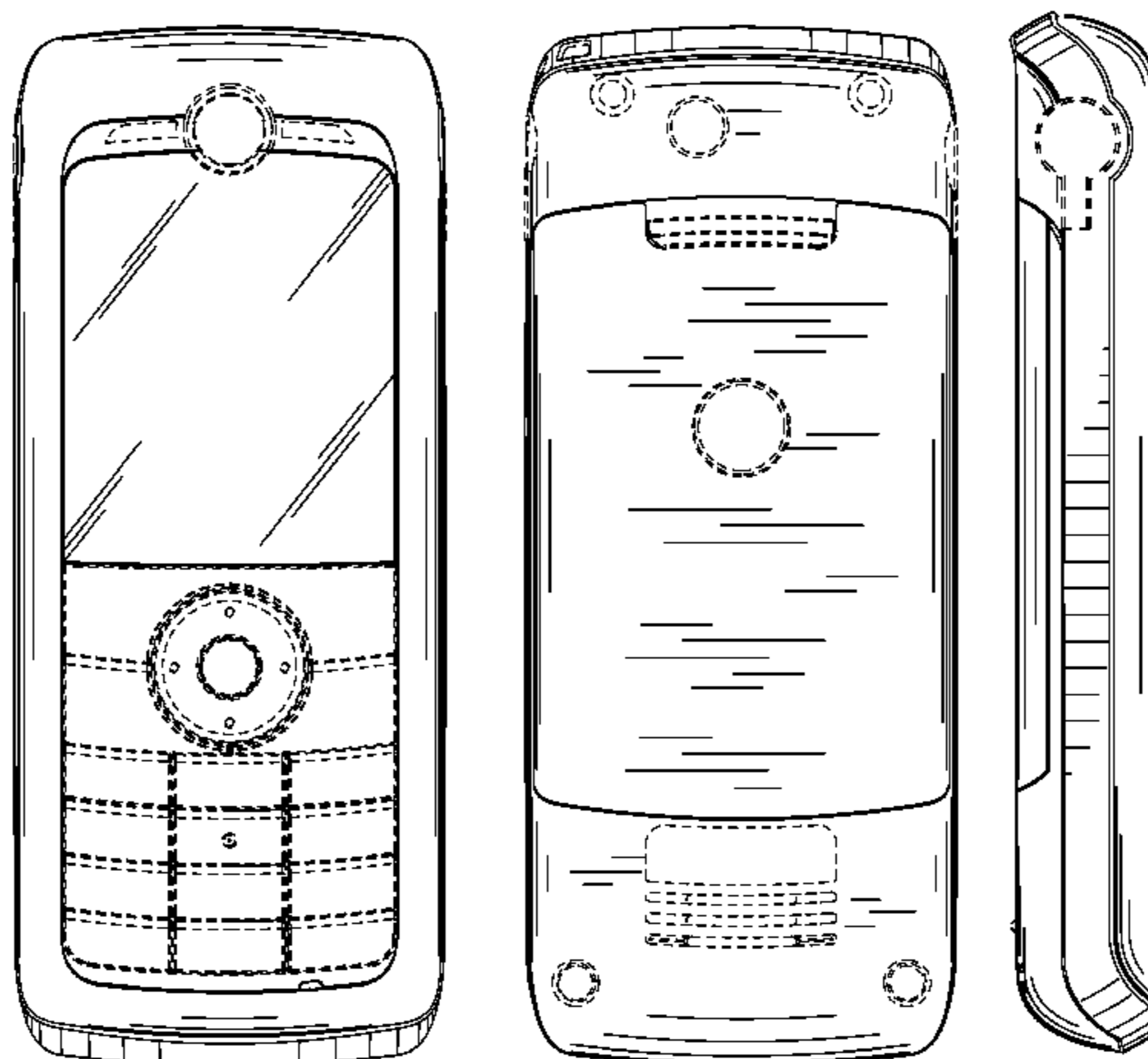
FIG. 5 is a second side view thereof.

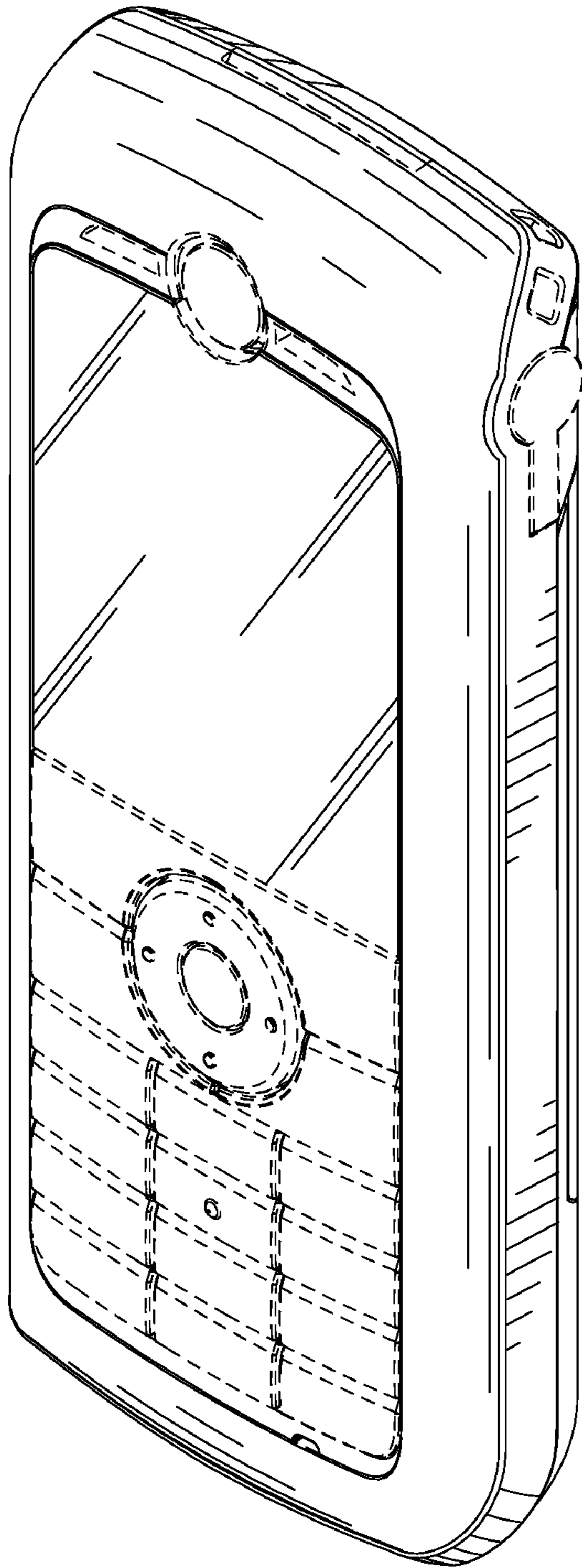
FIG. 6 is a top view thereof; and,

FIG. 7 is a bottom view thereof.

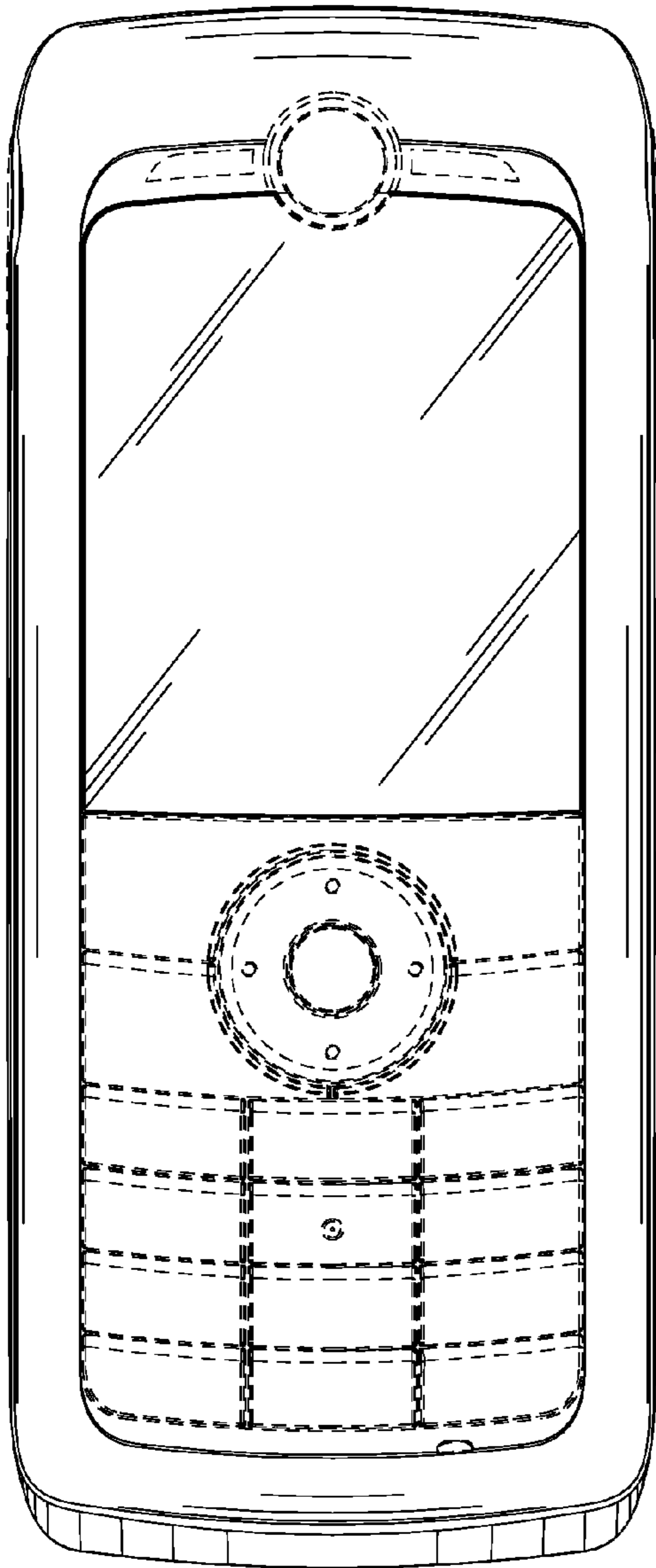
The broken line showing of environmental structures is for illustrative purposes only and forms no part of the claimed design.

**1 Claim, 4 Drawing Sheets**

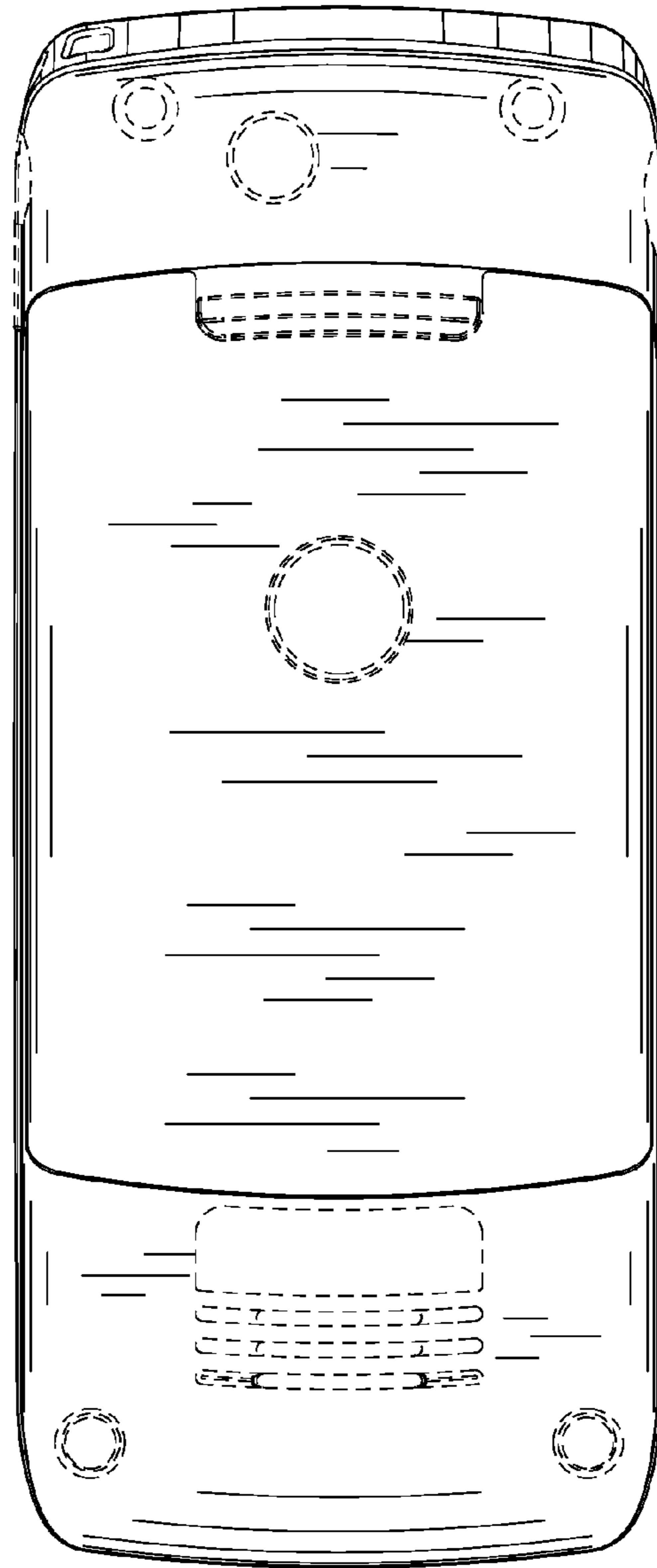




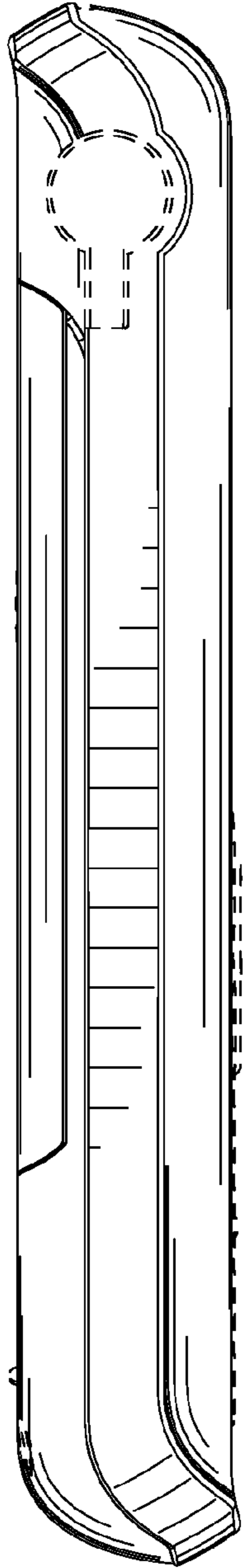
*FIG. 1*



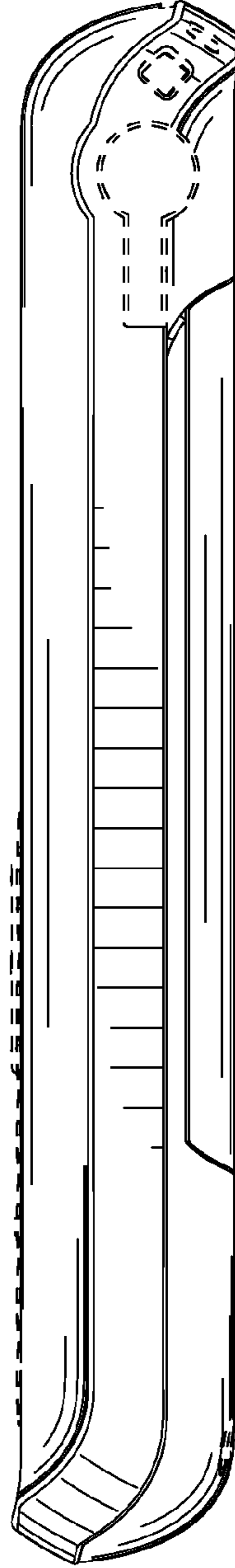
*FIG. 2*



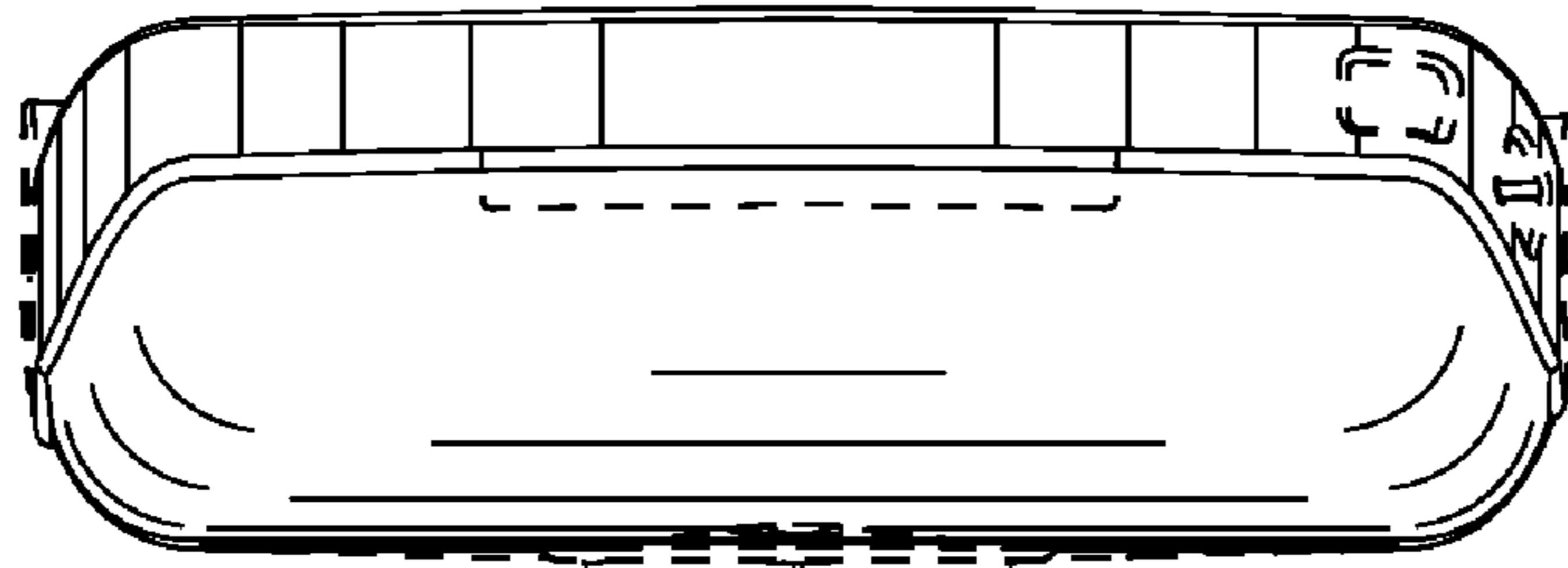
*FIG. 3*



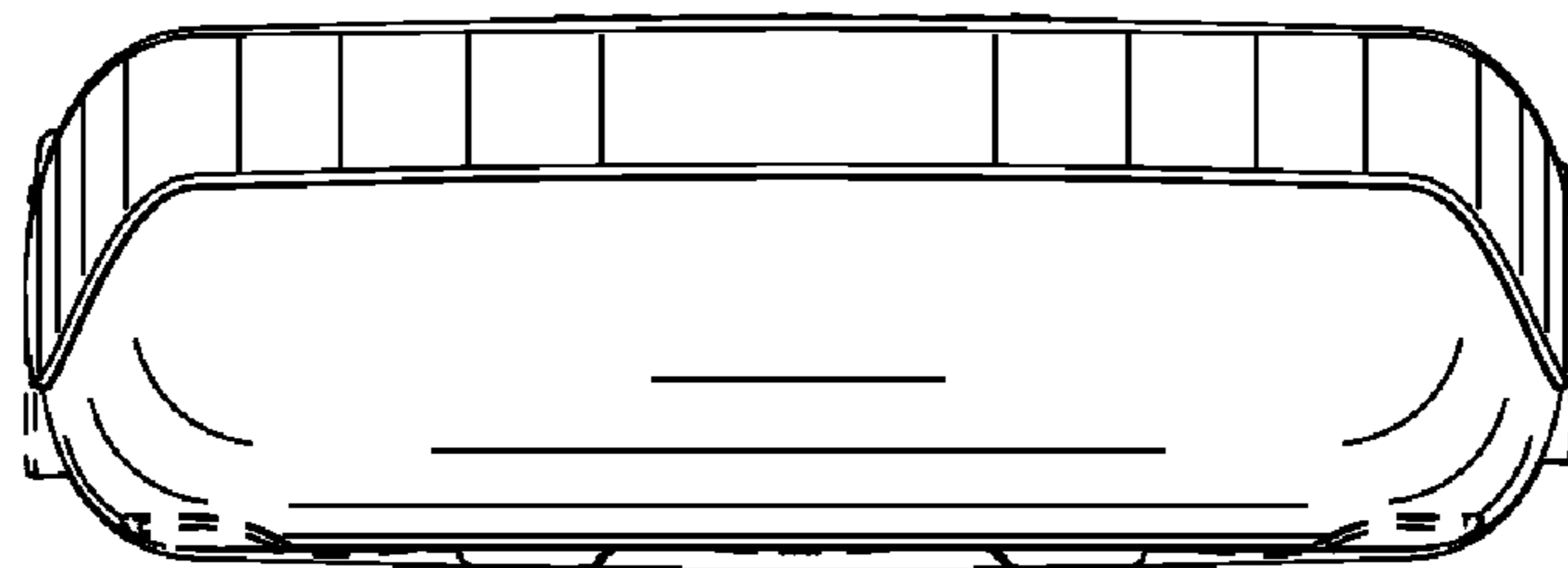
*FIG. 4*



*FIG. 5*



*FIG. 6*



*FIG. 7*