



US00D562292S

(12) **United States Design Patent**
Park

(10) **Patent No.:** **US D562,292 S**

(45) **Date of Patent:** **** Feb. 19, 2008**

(54) **MOBILE PHONE**

(75) Inventor: **Sun Ha Park**, Seoul (KR)

(73) Assignee: **LG Electronics Inc.**, Seoul (KR)

(**) Term: **14 Years**

(21) Appl. No.: **29/272,837**

(22) Filed: **Feb. 21, 2007**

(30) **Foreign Application Priority Data**

Aug. 22, 2006 (KR) 30-2006-0034451

(51) **LOC (8) Cl.** **14-03**

(52) **U.S. Cl.** **D14/138**

(58) **Field of Classification Search** D14/137,
D14/138, 147, 218, 247-248, 341-347, 496;
455/90.3, 556.1, 556.2, 575.1, 575.3, 575.4;
379/433.01-433.13; 361/814; 348/14.02
See application file for complete search history.

(56) **References Cited**

U.S. PATENT DOCUMENTS

D356,550 S *	3/1995	Mizusugi et al.	D14/341
D416,253 S *	11/1999	Hibino	D14/138
D456,805 S *	5/2002	Ono et al.	D14/342
D464,961 S *	10/2002	Sogabe	D14/346
D467,890 S *	12/2002	Lai et al.	D14/138
D488,468 S *	4/2004	Hu	D14/341
D488,470 S *	4/2004	Morisawa	D14/345
D495,695 S *	9/2004	Yugaya	D14/346
D498,736 S *	11/2004	Lee	D14/138
D520,515 S *	5/2006	Sitoh	D14/496
D523,445 S *	6/2006	Toh	D14/496
D524,809 S *	7/2006	Alcouloumre et al.	D14/341
D527,366 S *	8/2006	Lee	D14/138
D528,526 S *	9/2006	Shin	D14/138
D529,887 S *	10/2006	Chung et al.	D14/138
D530,698 S *	10/2006	Lee et al.	D14/138
D533,565 S *	12/2006	Kim	D14/496
7,181,256 B2 *	2/2007	Hyun et al.	455/575.3
D543,531 S *	5/2007	Lee	D14/138
D546,804 S *	7/2007	Lee et al.	D14/138

D547,743 S *	7/2007	Kim et al.	D14/138
2005/0107137 A1 *	5/2005	Byun et al.	455/575.1
2007/0082718 A1 *	4/2007	Yoon et al.	455/575.4
2007/0123322 A1 *	5/2007	Mizushina	455/575.1

OTHER PUBLICATIONS

Asus P535, announced Nov. 2006, [online], [retrieved on Feb. 20, 2007]. Retrieved from Internet ,<URL: <http://www.gsmarena.com>>.*

NEC N930, announced 4th quarter 2004, [online], [retrieved on Feb. 20, 2007]. Retrieved from Internet ,<URL: <http://www.gsmarena.com>>.*

LG KE850 Prada, announced Jan. 2007, [online], [retrieved on Feb. 20, 2007]. Retrieved from Internet ,<URL: <http://www.gsmarena.com>>.*

LG KU970 Shine, announced Feb. 2007, [online], [retrieved on Feb. 20, 2007]. Retrieved from Internet ,<URL: <http://www.gsmarena.com>>.*

(Continued)

Primary Examiner—Jeffrey Asch

Assistant Examiner—Bridget L Eland

(74) *Attorney, Agent, or Firm*—Birch, Stewart, Kolasch & Birch, LLP

(57) **CLAIM**

The ornamental design for a mobile phone, as shown and described.

DESCRIPTION

FIG. 1 is a perspective view of a mobile phone showing my new design;

FIG. 2 is a front view thereof;

FIG. 3 is a rear view thereof;

FIG. 4 is a left side view thereof;

FIG. 5 is a right side view thereof;

FIG. 6 is a top plan view thereof;

FIG. 7 is a bottom plan view thereof; and,

FIG. 8 is a front view thereof in a condition that the upper body thereof is slided upward and the inner key pad is exposed.

1 Claim, 5 Drawing Sheets

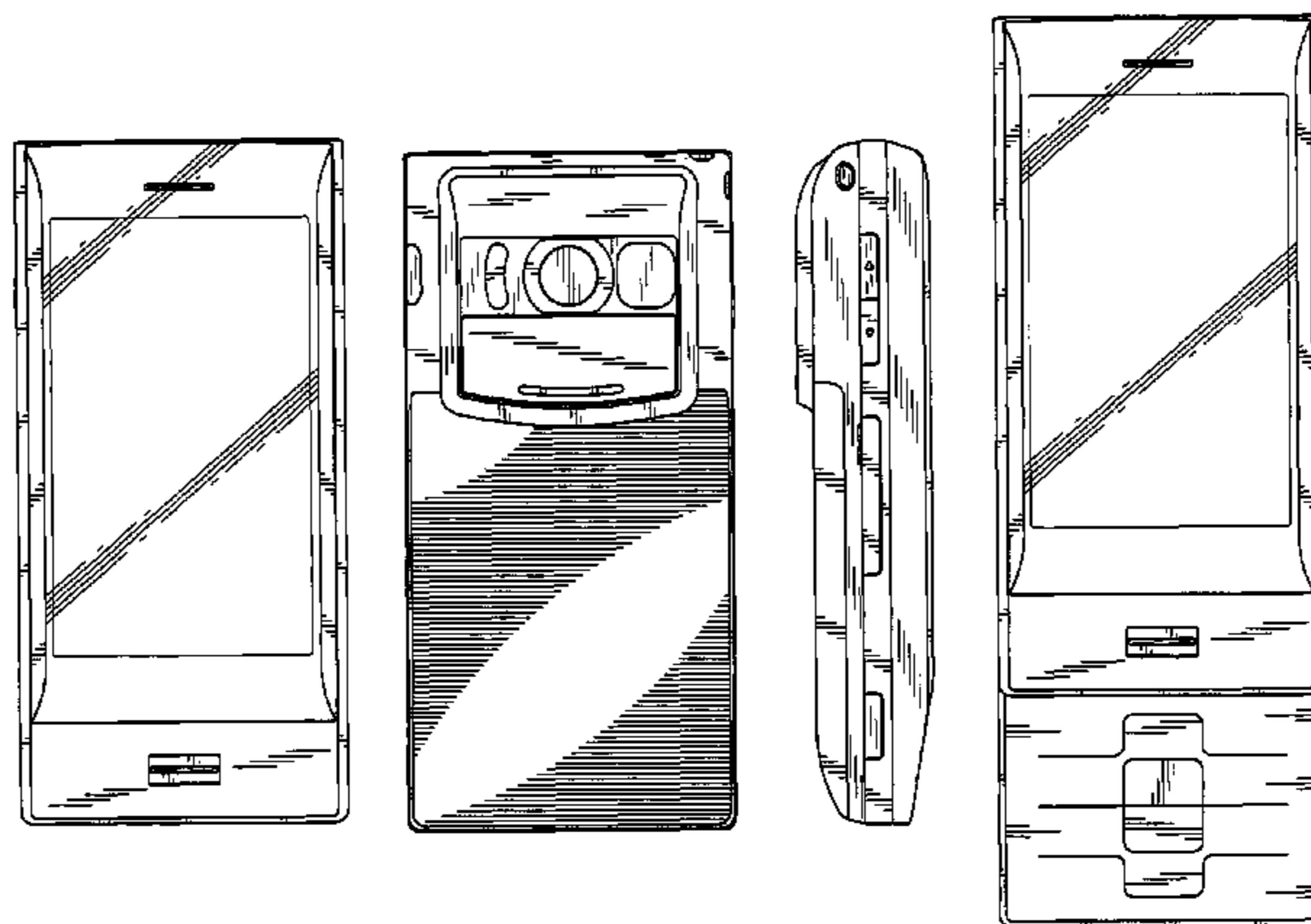

OTHER PUBLICATIONS

Eten g1ofish X500, announced Oct. 2006, [online], [retrieved on Feb. 20, 2007]. Retrieved from Internet ,<URL: <http://www.gsmarena.com>>.*

Philips S900, announced Jun. 2006, [online], [retrieved on Feb. 20, 2007]. Retrieved from Internet ,<URL: <http://www.gsmarena.com>>.*

* cited by examiner

FIG. 1

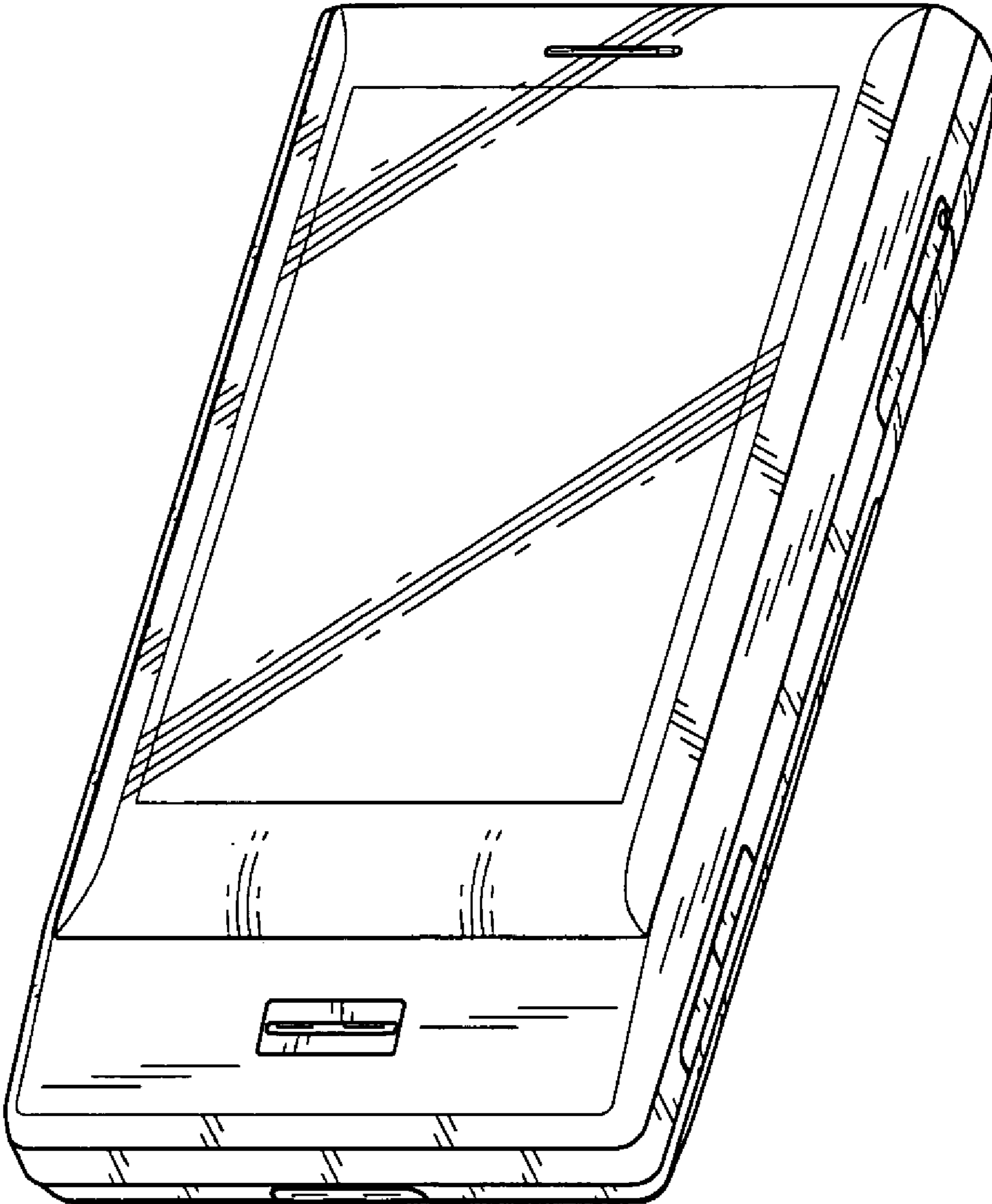

FIG. 2

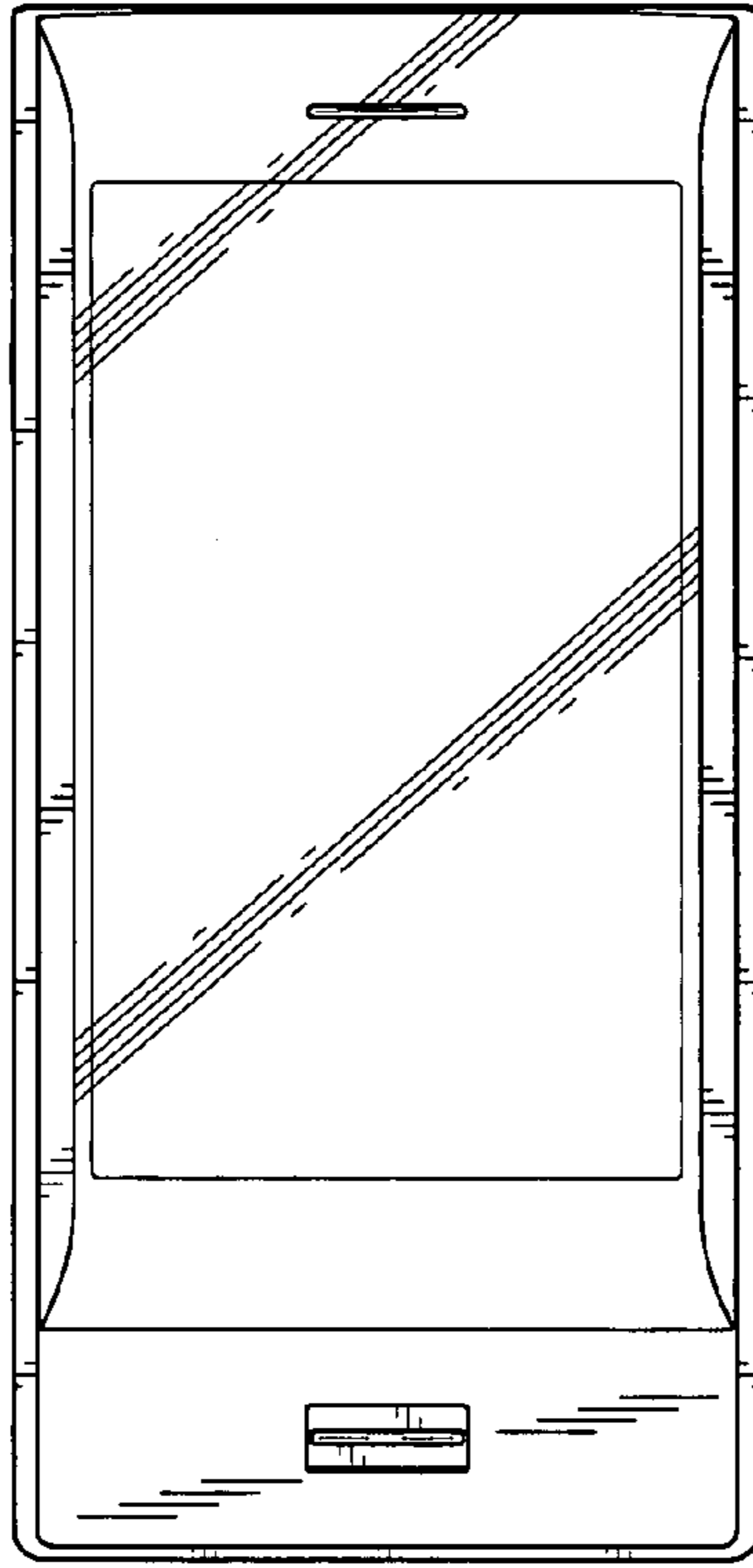

FIG. 3

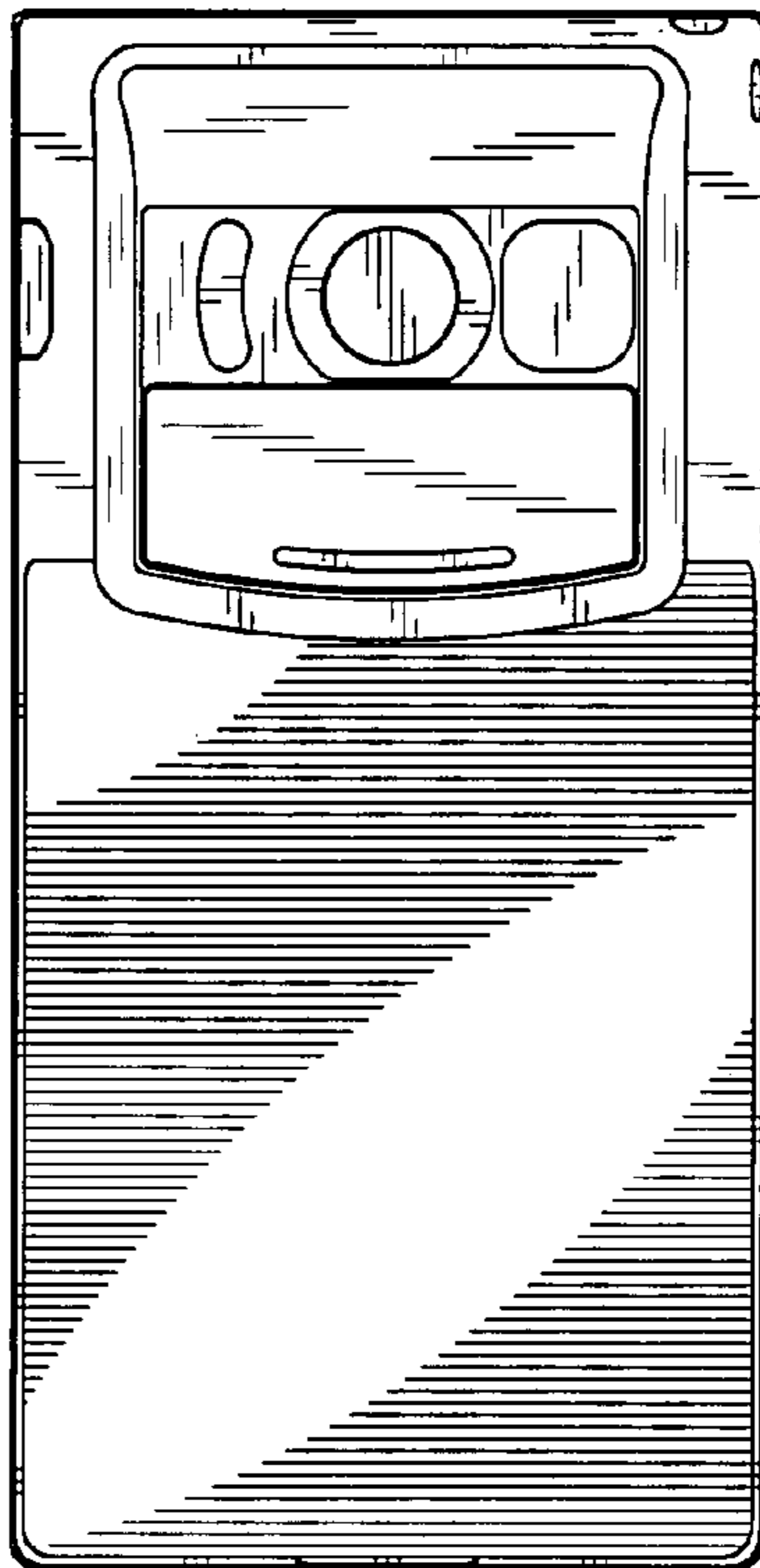

FIG. 4

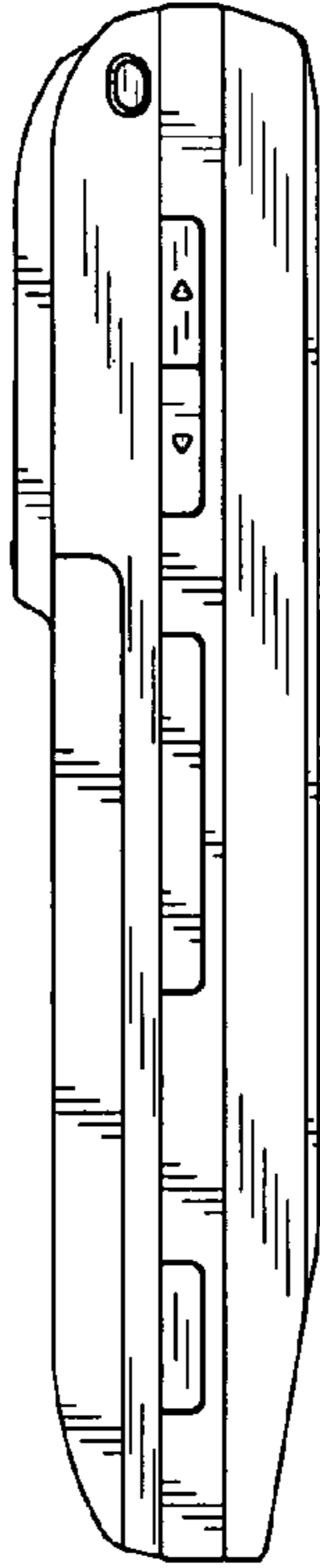

FIG. 5

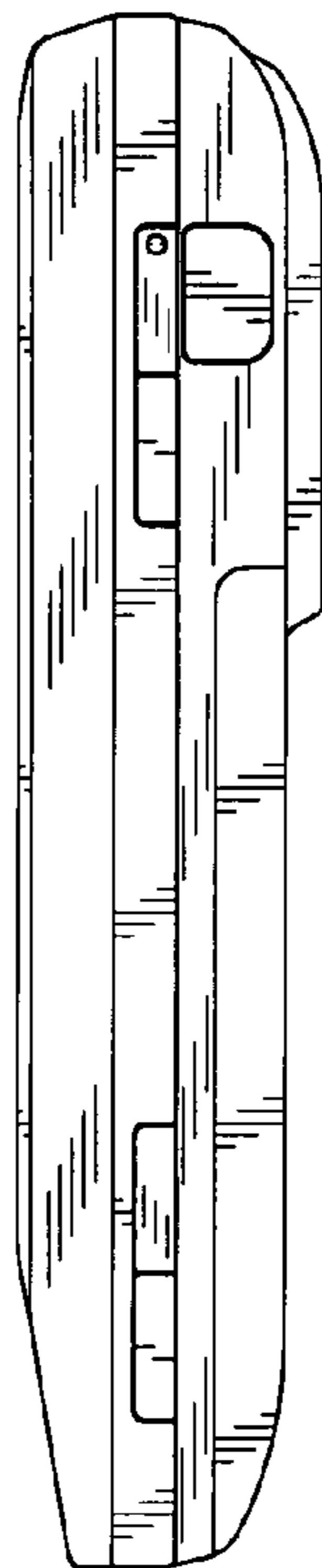

FIG. 6

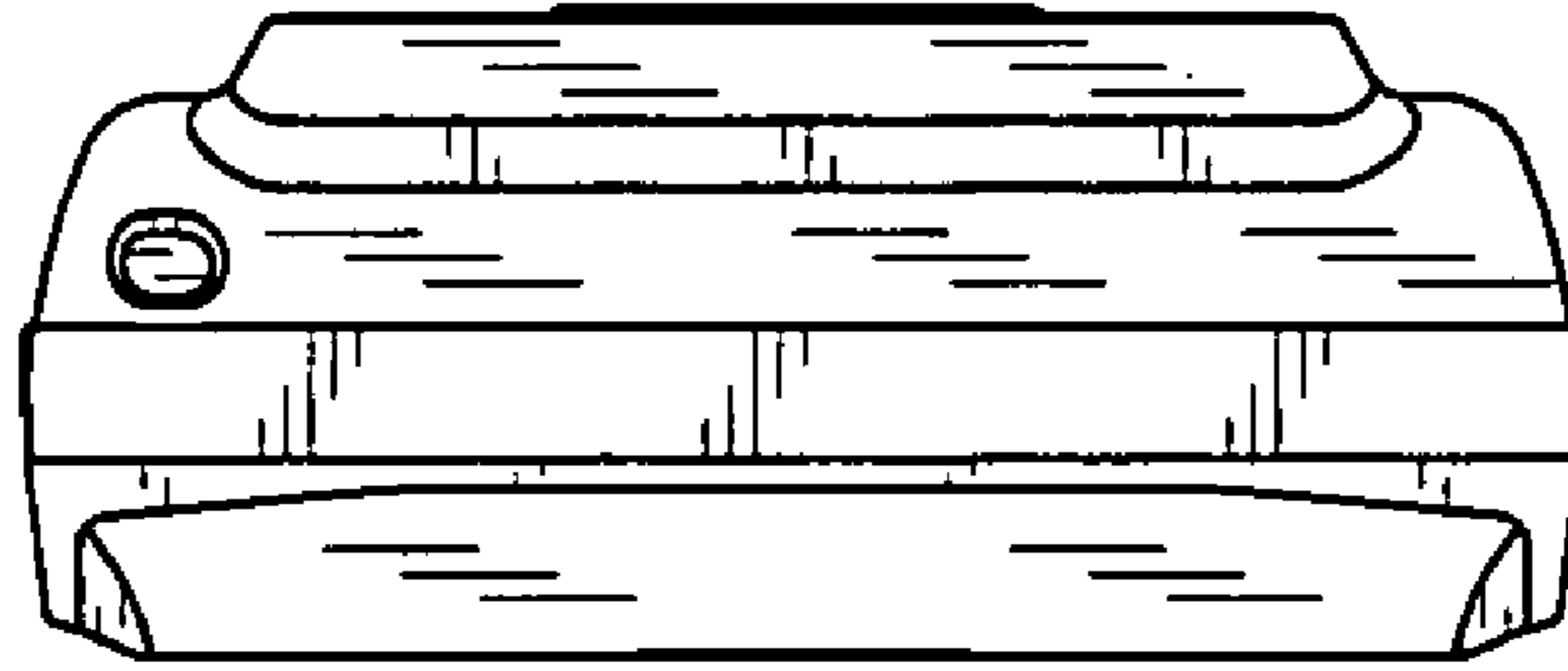

FIG. 7

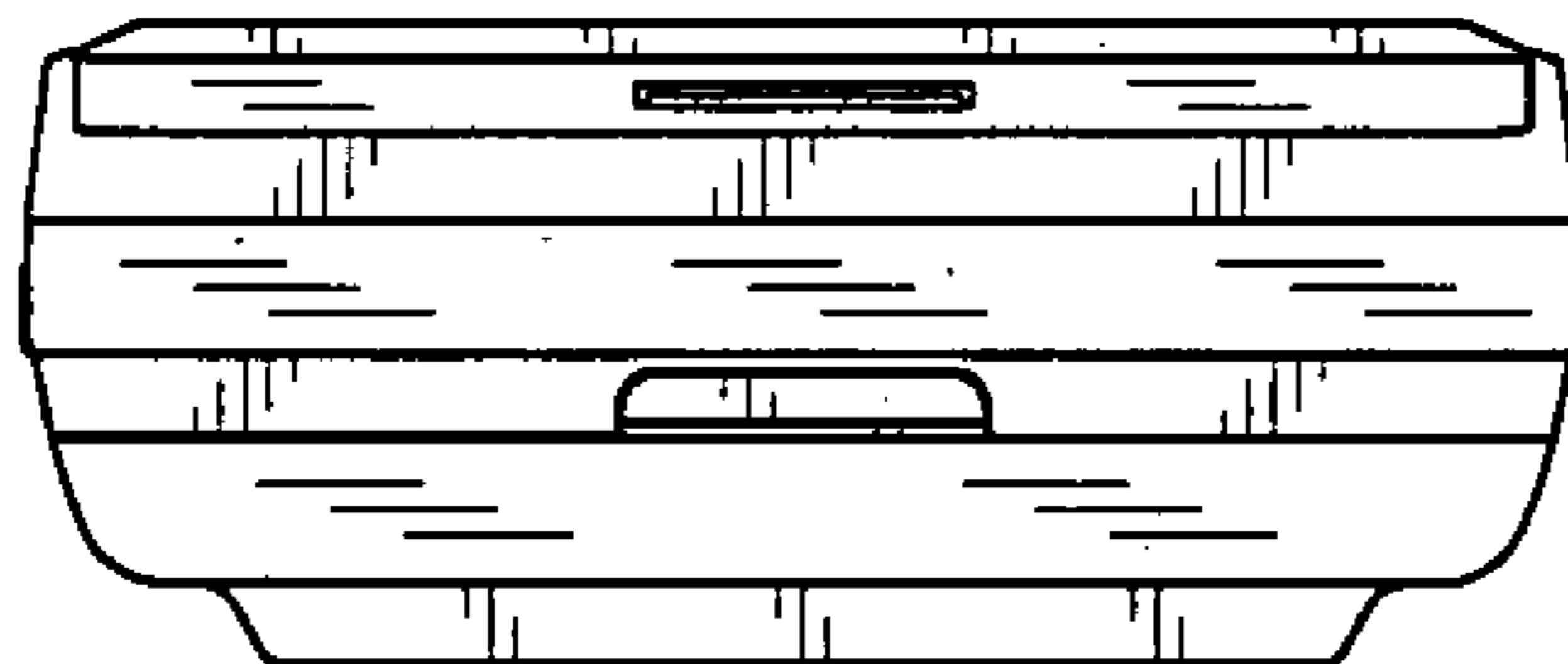

FIG. 8

