



US00D562277S

(12) **United States Design Patent**
Zhang

(10) **Patent No.:** **US D562,277 S**

(45) **Date of Patent:** **** Feb. 19, 2008**

(54) **DVD PLAYER**

(74) *Attorney, Agent, or Firm*—Mayer Brown LLP

(75) **Inventor:** **Yongde Zhang**, Guang Dong (CN)

(57) **CLAIM**

(73) **Assignee:** **Coby Electronics Corporation**,
Maspeth, NY (US)

The ornamental design of a DVD player, as shown and described.

(**) **Term:** **14 Years**

DESCRIPTION

(21) **Appl. No.:** **29/250,603**

A portion of this patent document contains material which is subject to copyright protection. The copyright owner has no objection to the facsimile reproduction by anyone of the patent document or the patent disclosure, as it appears in the Patent and Trademark Office patent files or records, but otherwise reserves all copyrights whatsoever.

(22) **Filed:** **Nov. 22, 2006**

(51) **LOC (8) Cl.** **14-01**

(52) **U.S. Cl.** **D14/136**

(58) **Field of Classification Search** D14/135–136,
D14/156–157, 167–168, 197–198, 188, 357,
D14/445; 360/99.02, 99.07, 137; 369/75.11,
369/75.21, 77.21, 77.11; 720/612, 619, 647,
720/655; 455/344, 347–351

See application file for complete search history.

FIG. 1 is a perspective view of a DVD player according to an embodiment of my new design;

FIG. 2 is a front view thereof;

FIG. 3 is a rear view thereof;

FIG. 4 is a left side view thereof;

FIG. 5 is a right side view thereof;

FIG. 6 is top view thereof; and,

FIG. 7 is a bottom view thereof.

The Broken line showings throughout the views are for illustrative purposes only and form no part of the claimed design.

(56) **References Cited**

U.S. PATENT DOCUMENTS

D439,228 S * 3/2001 Tsuge D14/136

D462,941 S * 9/2002 Woo D14/136

D526,293 S * 8/2006 Ryu D14/136

D530,691 S * 10/2006 Moriya et al. D14/168

* cited by examiner

Primary Examiner—Nanda Bondade

1 Claim, 5 Drawing Sheets

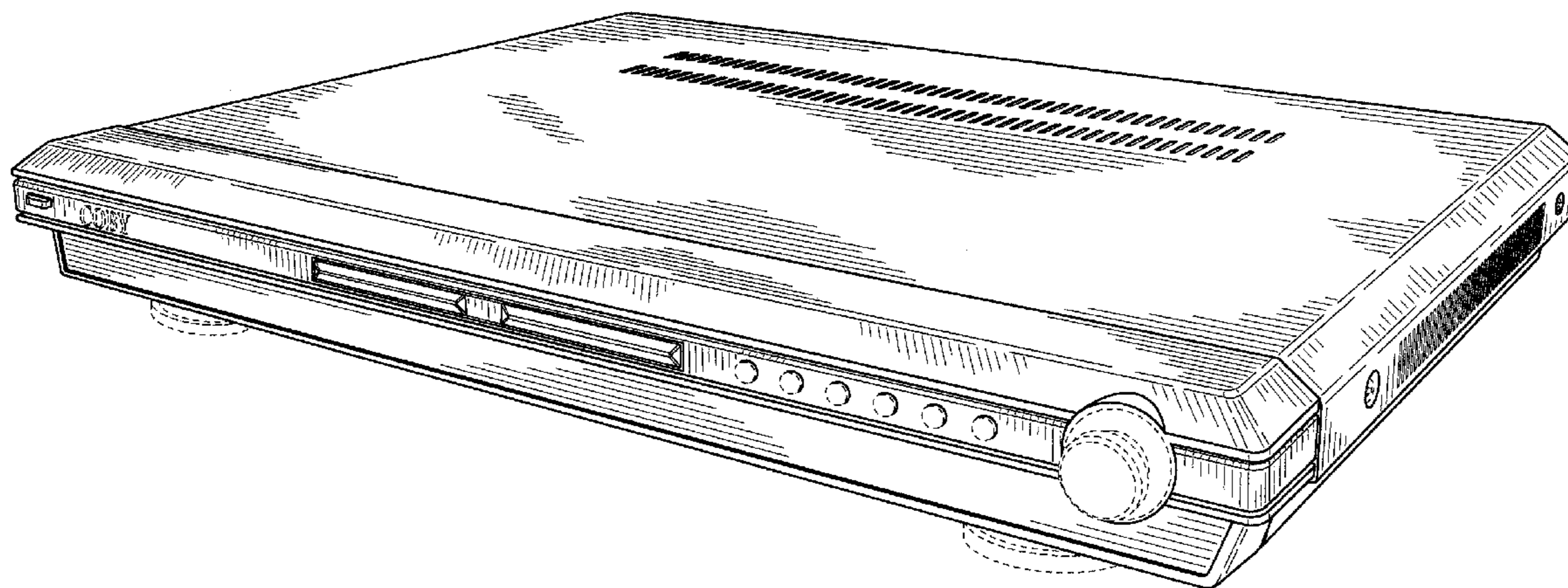

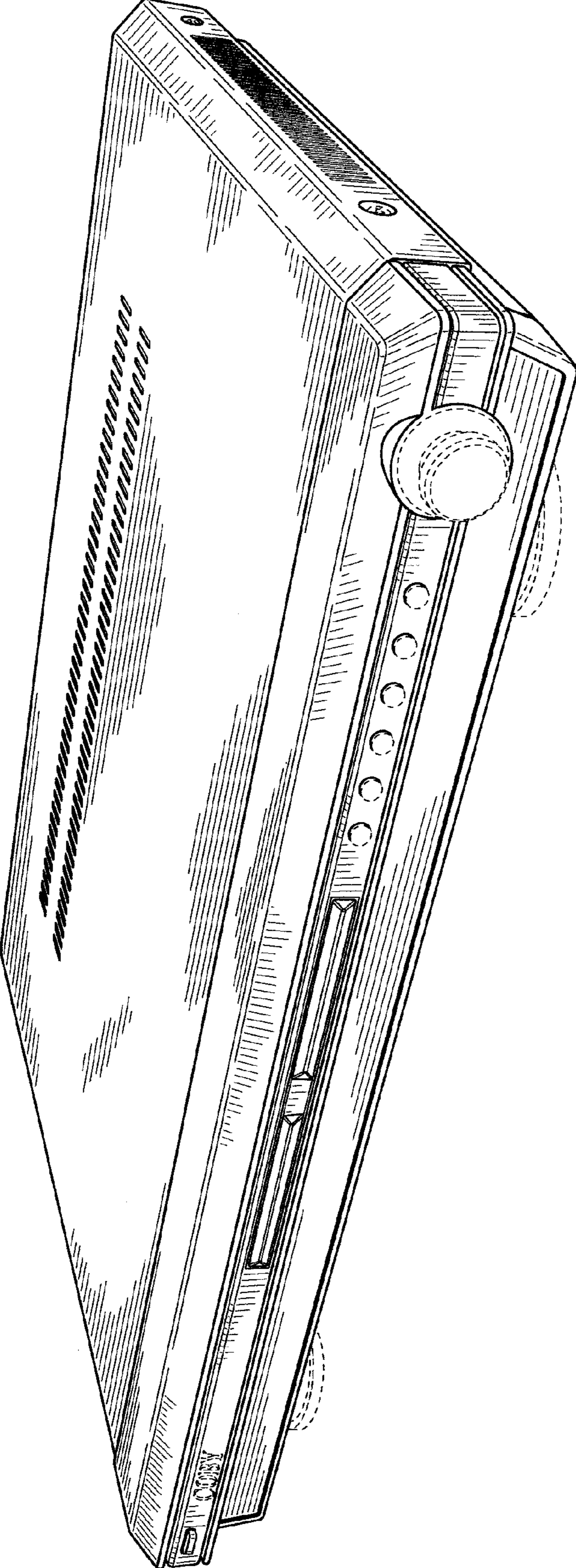

FIG. 1

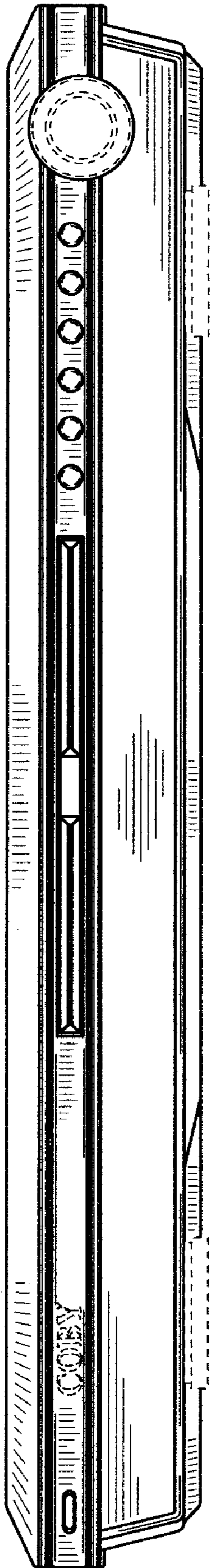

FIG. 2

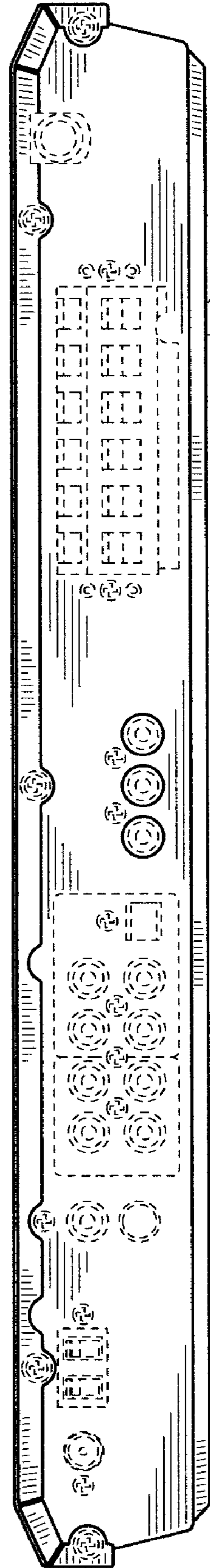

FIG. 3

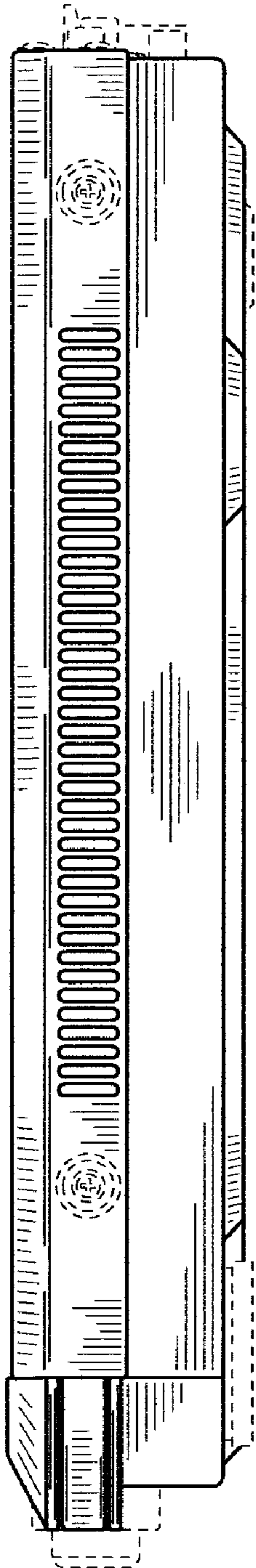

FIG. 4

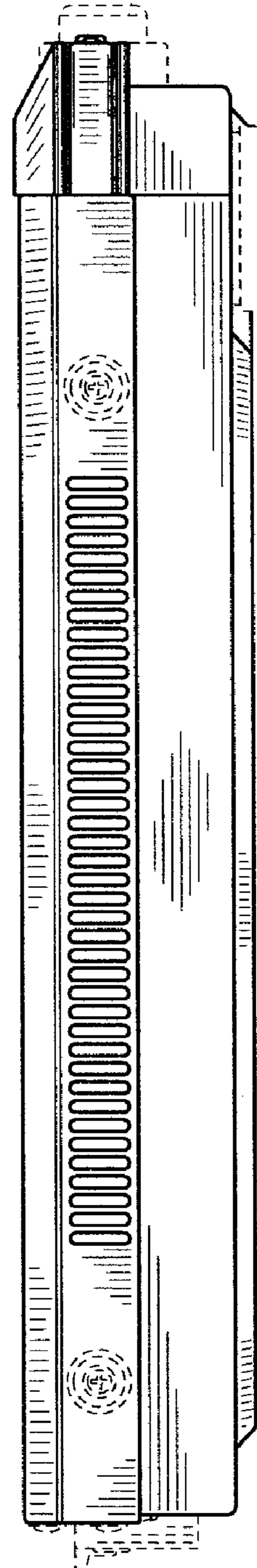

FIG. 5

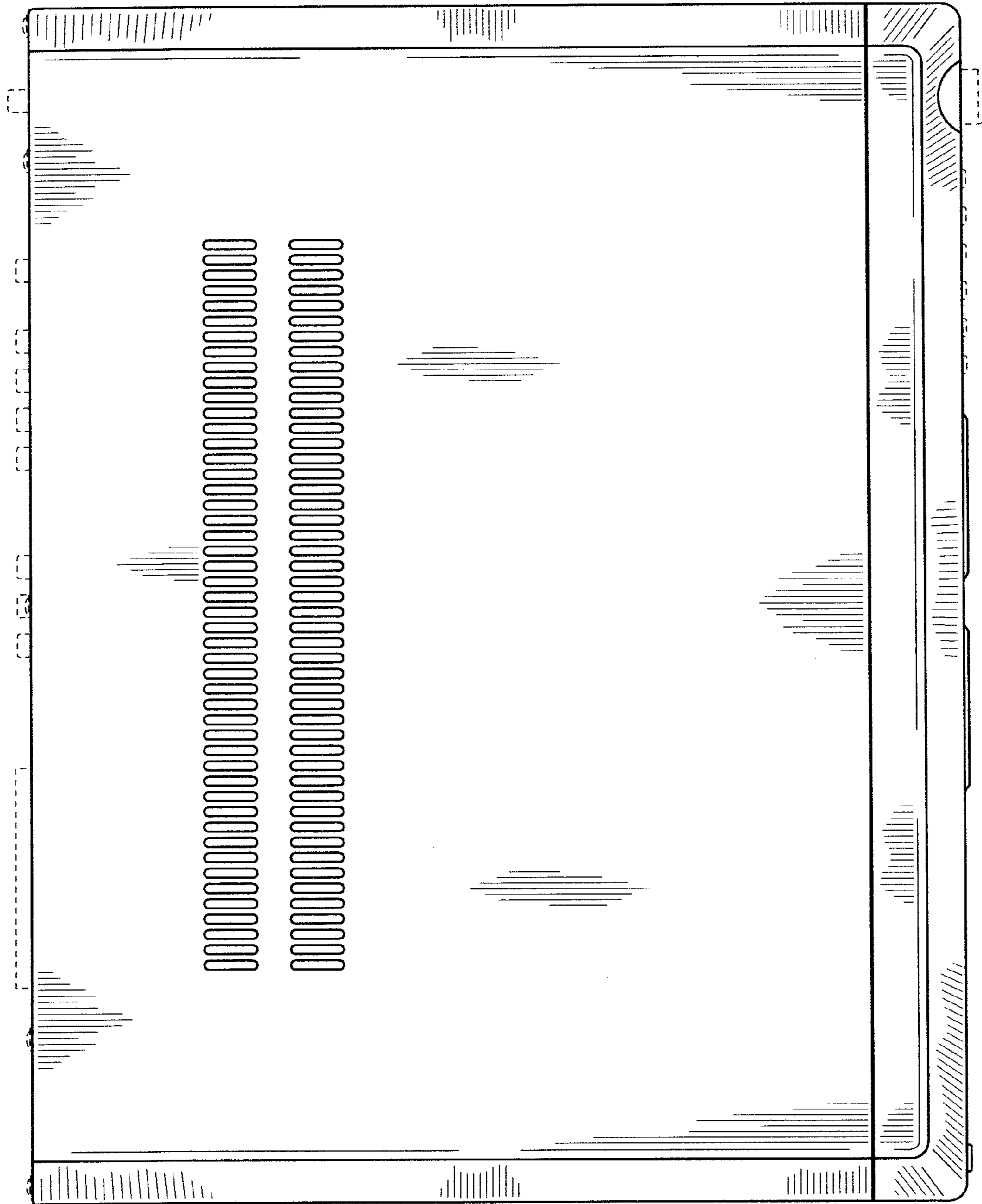

FIG. 6

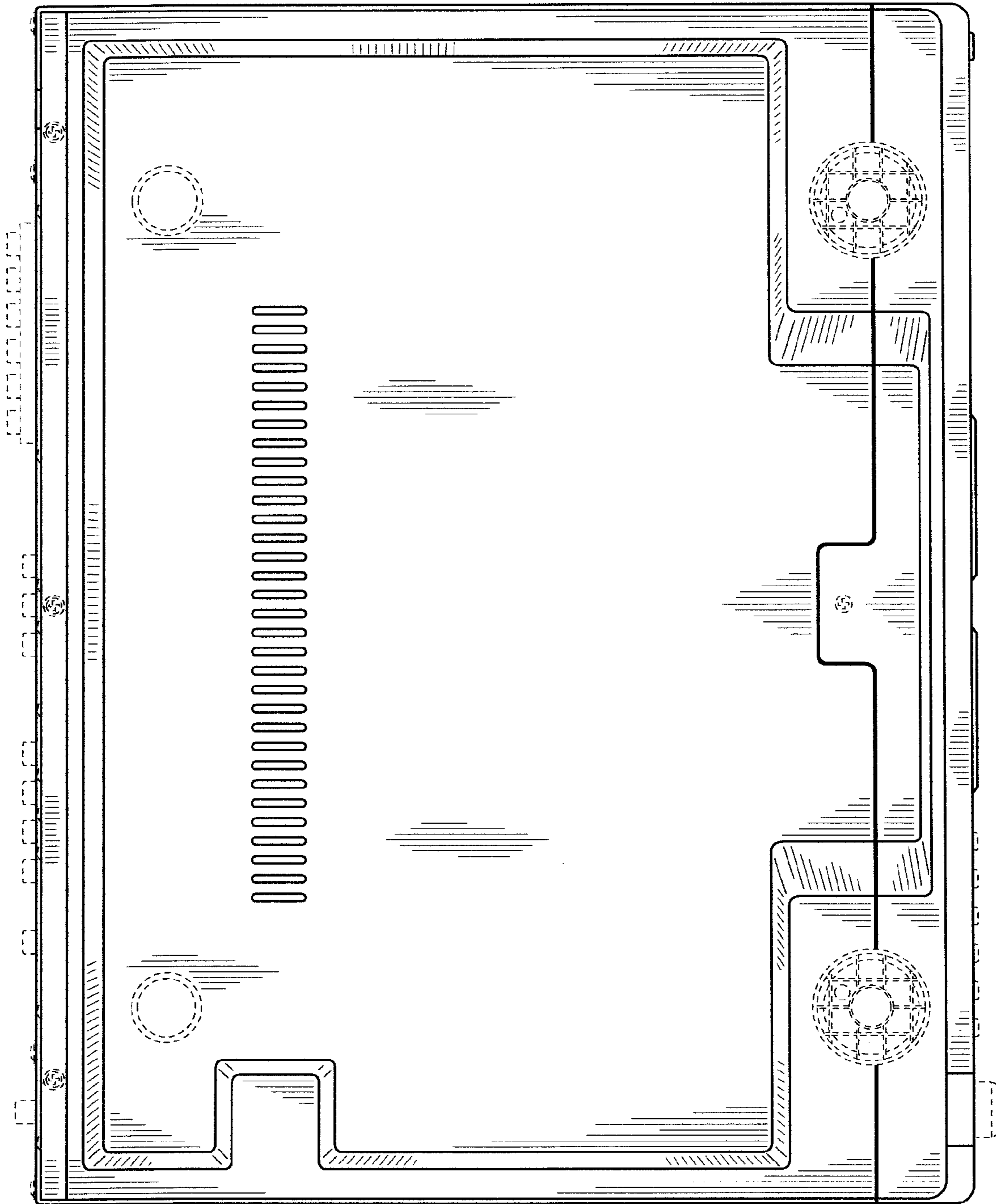

FIG. 7