



US00D562189S

(12) **United States Design Patent**
Miwa et al.

(10) **Patent No.:** **US D562,189 S**
(45) **Date of Patent:** **** Feb. 19, 2008**

(54) **FRONT COVER FOR FOUR WHEEL VEHICLE**

(75) Inventors: **Koji Miwa**, Wako (JP); **Takao Mikami**, Wako (JP)

(73) Assignee: **Honda Motor Co., Ltd.**, Tokyo (JP)

(**) Term: **14 Years**

(21) Appl. No.: **29/260,172**

(22) Filed: **May 22, 2006**

(30) **Foreign Application Priority Data**

Nov. 22, 2005 (JP) 2005-034278

(51) **LOC (8) Cl.** **12-11**

(52) **U.S. Cl.** **D12/107**

(58) **Field of Classification Search** D12/3,
D12/86, 87, 110, 107, 126, 181, 182, 184,
D12/186, 164, 173; 180/225, 229, 233, 311,
180/312, 315; 296/77.1, 78.1, 180.1, 192,
296/193.01, 193.09, 193.11; 280/152.1-152.3,
280/847-852

See application file for complete search history.

(56) **References Cited**

U.S. PATENT DOCUMENTS

7,097,207 B2* 8/2006 Kudo et al. 280/848

FOREIGN PATENT DOCUMENTS

JP 1179663 7/2003

* cited by examiner

Primary Examiner—Cathron Brooks

Assistant Examiner—Linda Brooks

(74) *Attorney, Agent, or Firm*—Birch, Stewart, Kolasch & Birch, LLP

(57) **CLAIM**

We claim the ornamental design for a front cover for four wheel vehicle, as shown and described.

DESCRIPTION

FIG. 1 is a perspective view from the front side of a front cover for four wheel vehicle.

FIG. 2 is a perspective view from the front side thereof.

FIG. 3 is a perspective view from the rear side thereof.

FIG. 4 is a perspective view from the rear side thereof.

FIG. 5 is a front elevation view thereof.

FIG. 6 is a rear elevation view thereof.

FIG. 7 is a right side elevation view thereof.

FIG. 8 is a left side elevation view thereof.

FIG. 9 is a top plan view thereof.

FIG. 10 is a bottom plan view thereof; and,

FIG. 11 is a perspective view thereof and reduced scale and shown in condition of use.

The broken lines shown in the drawings are for illustrative purposes only and form no part of the claimed design.

1 Claim, 11 Drawing Sheets

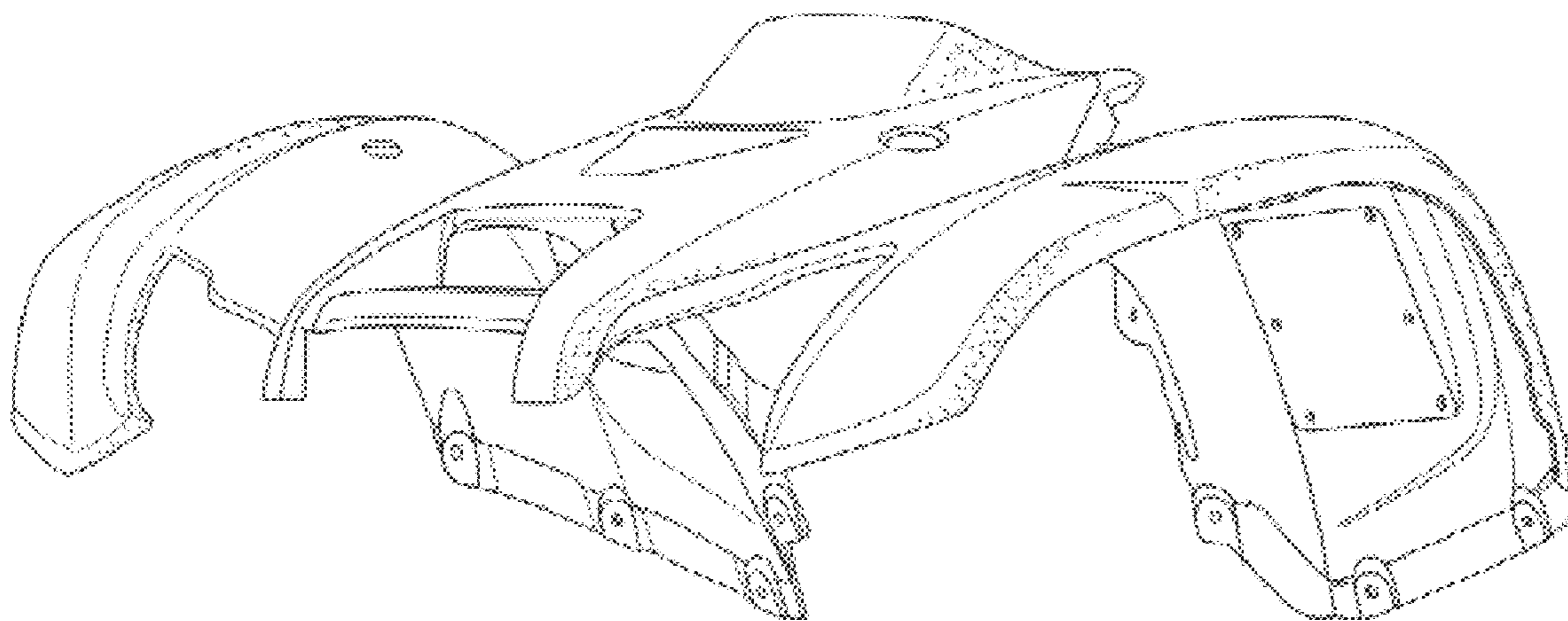

FIG. 1

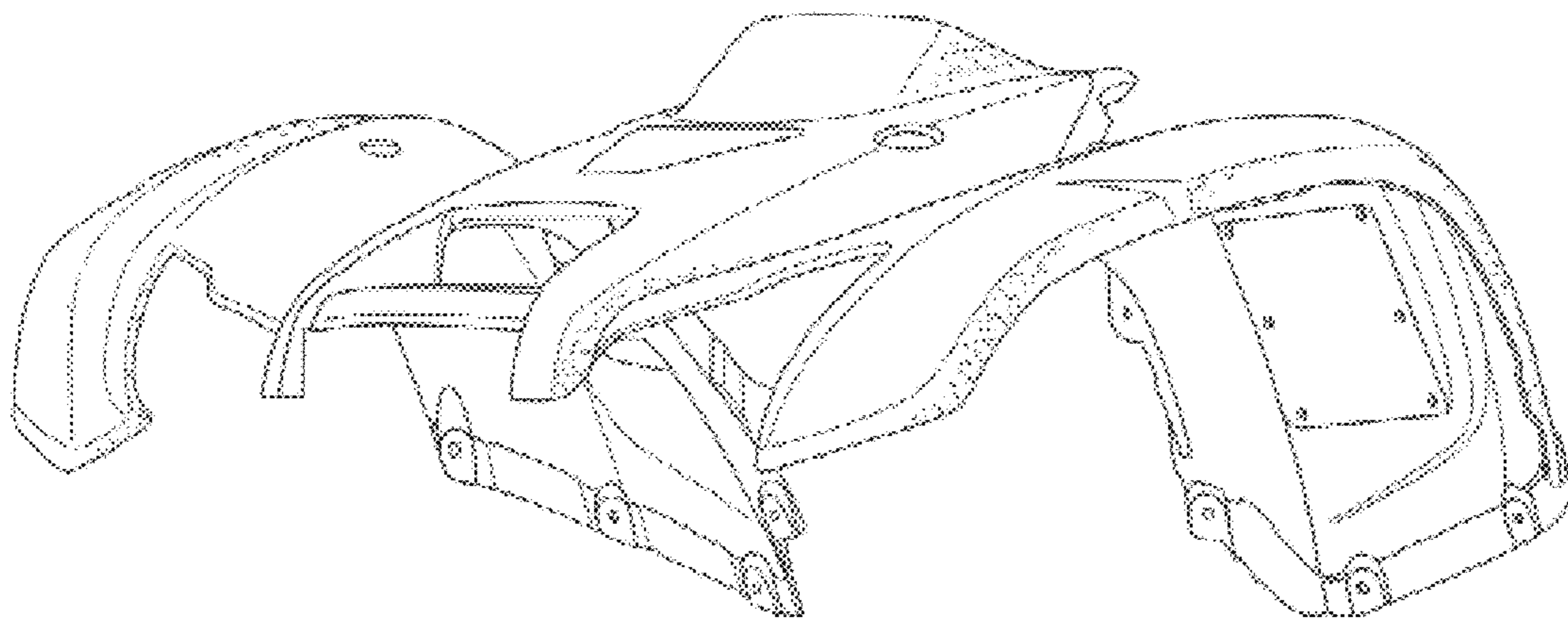

FIG. 2

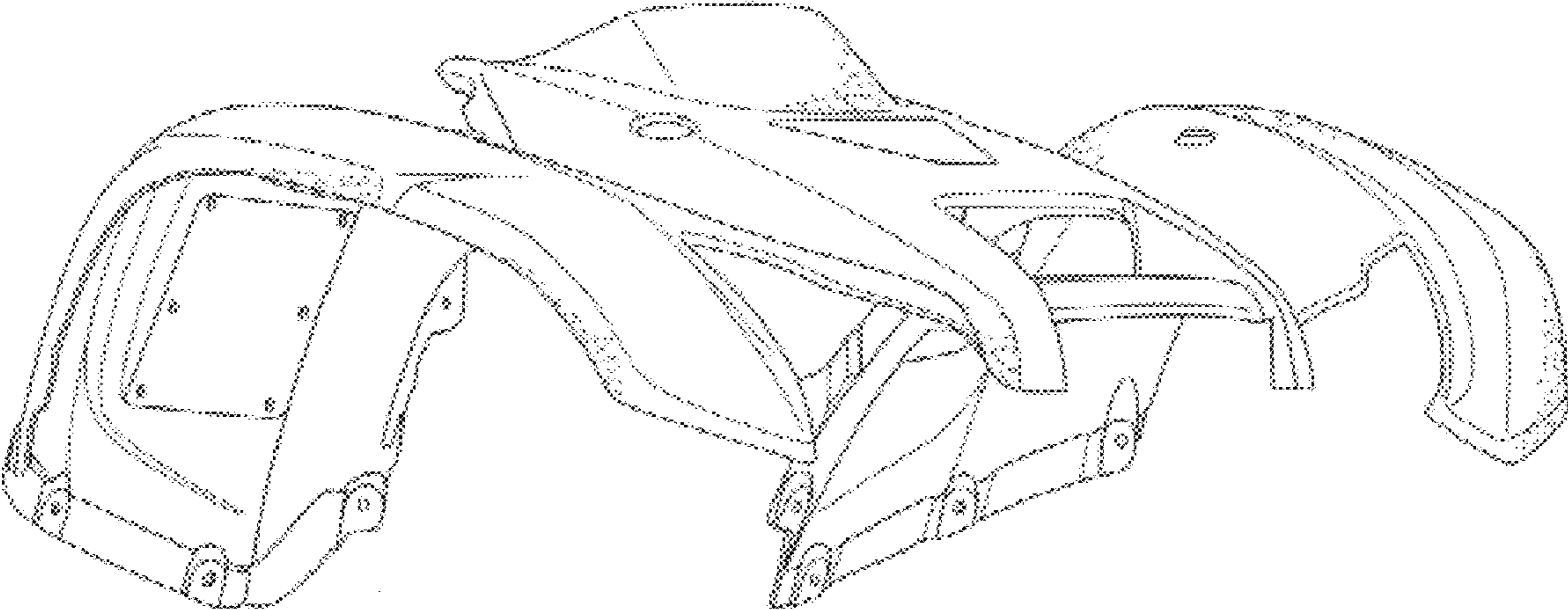

FIG. 3

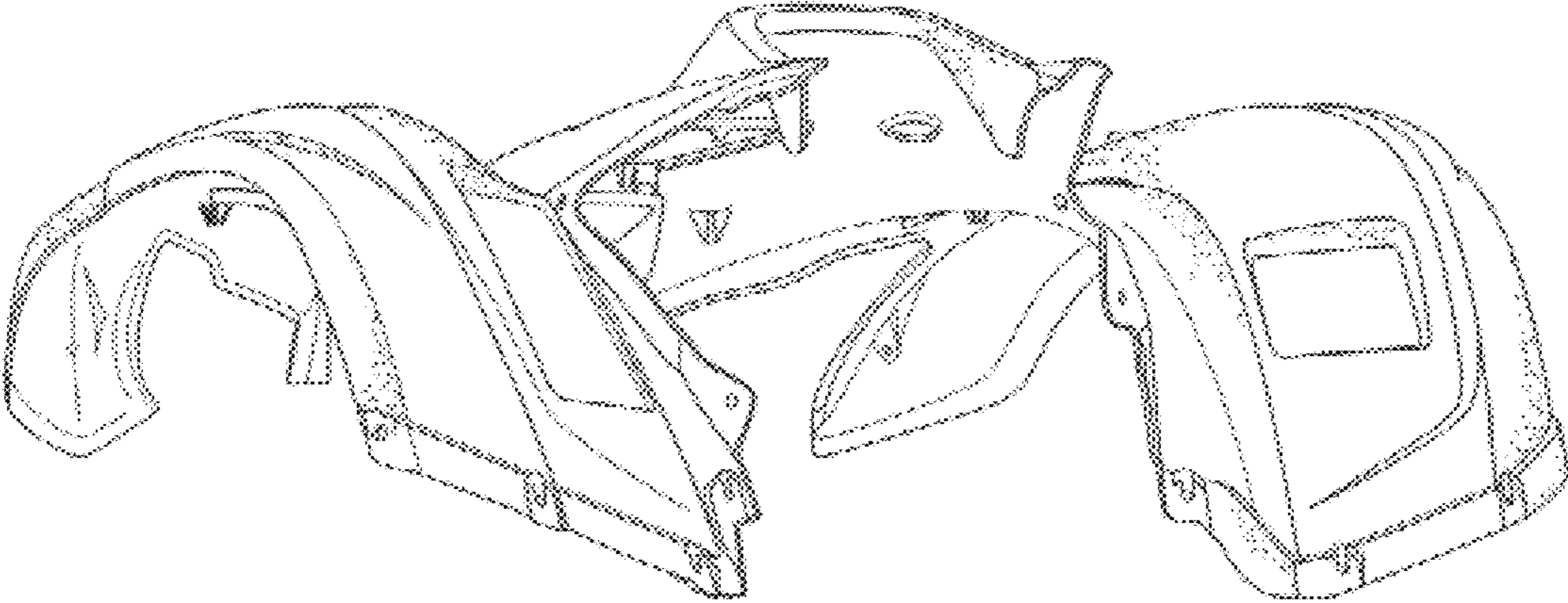

FIG. 4

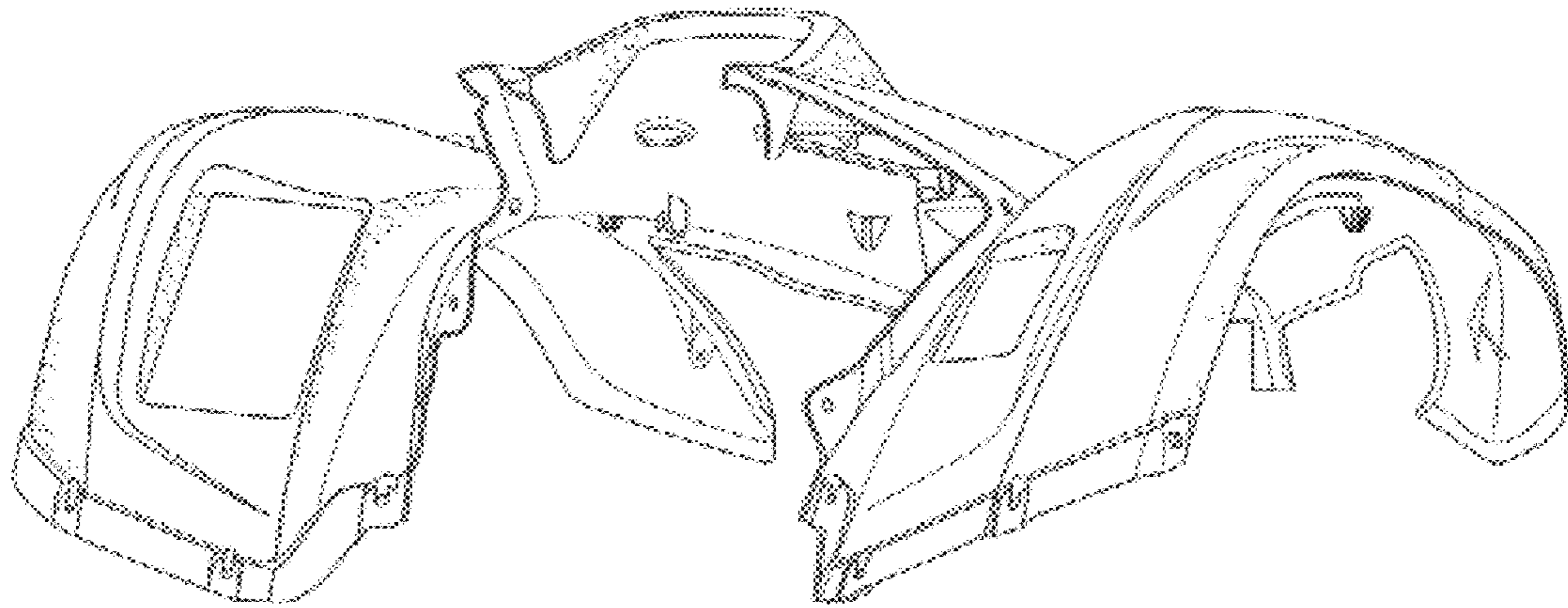

FIG. 5

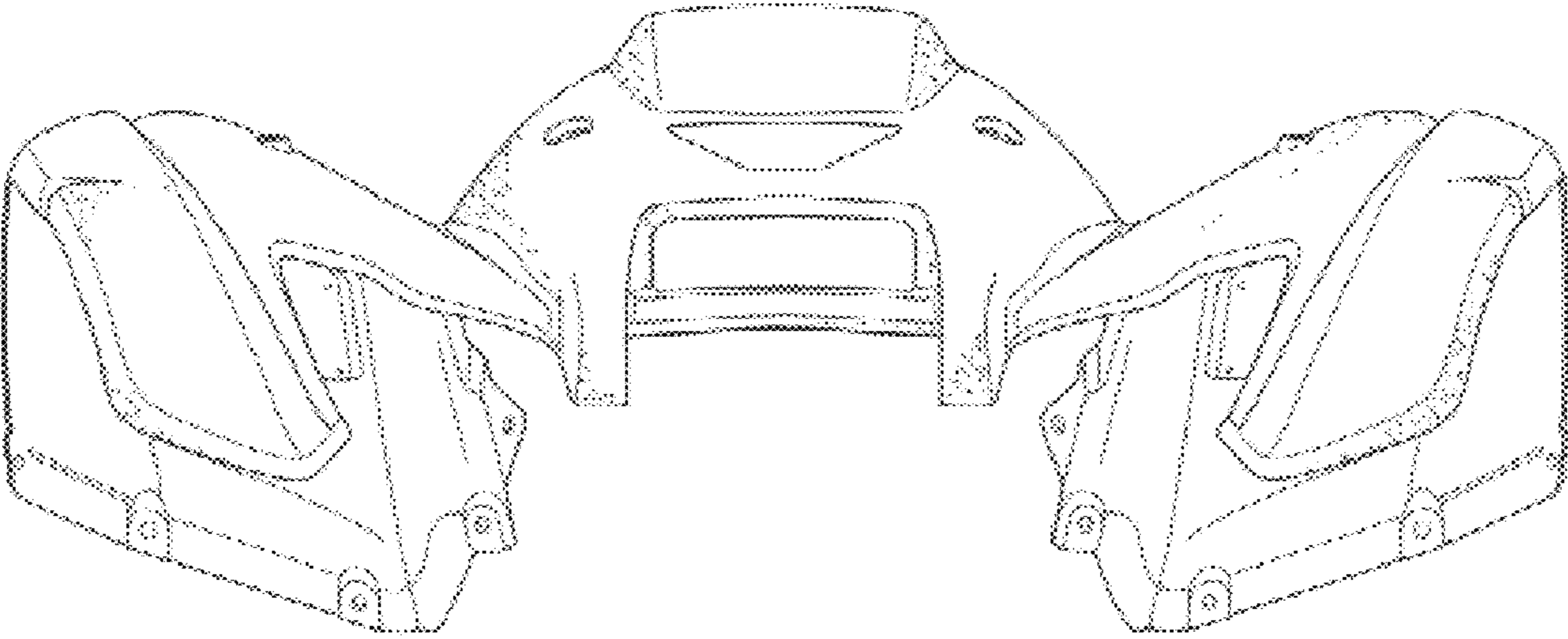

FIG. 6

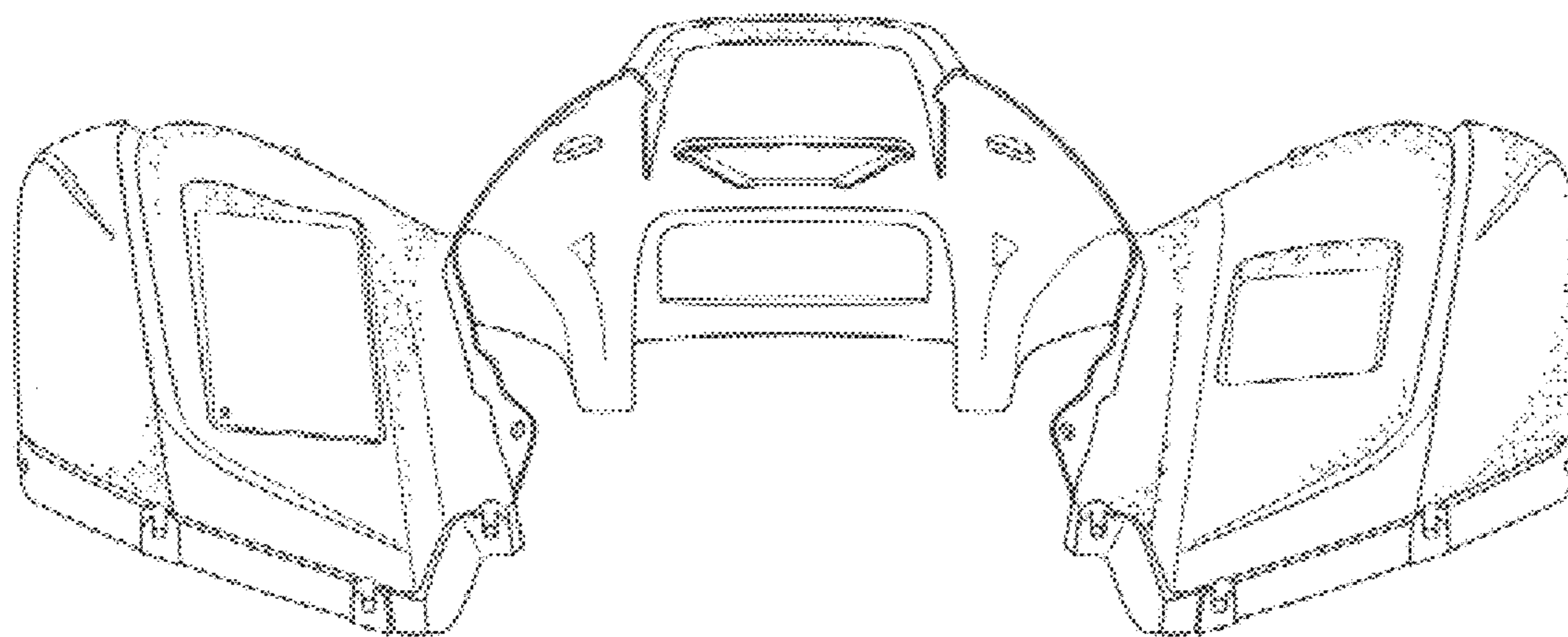

FIG. 7

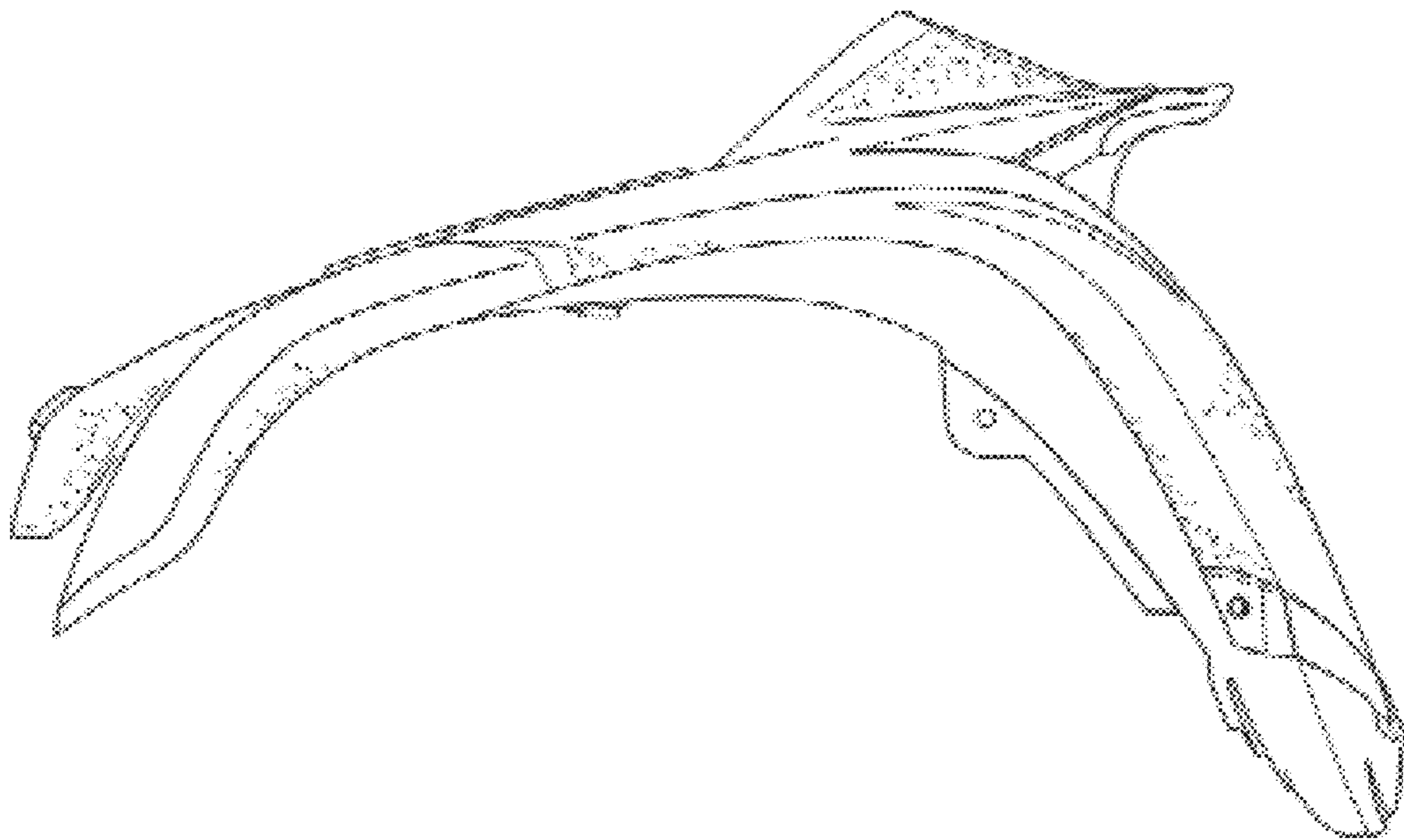

FIG. 8

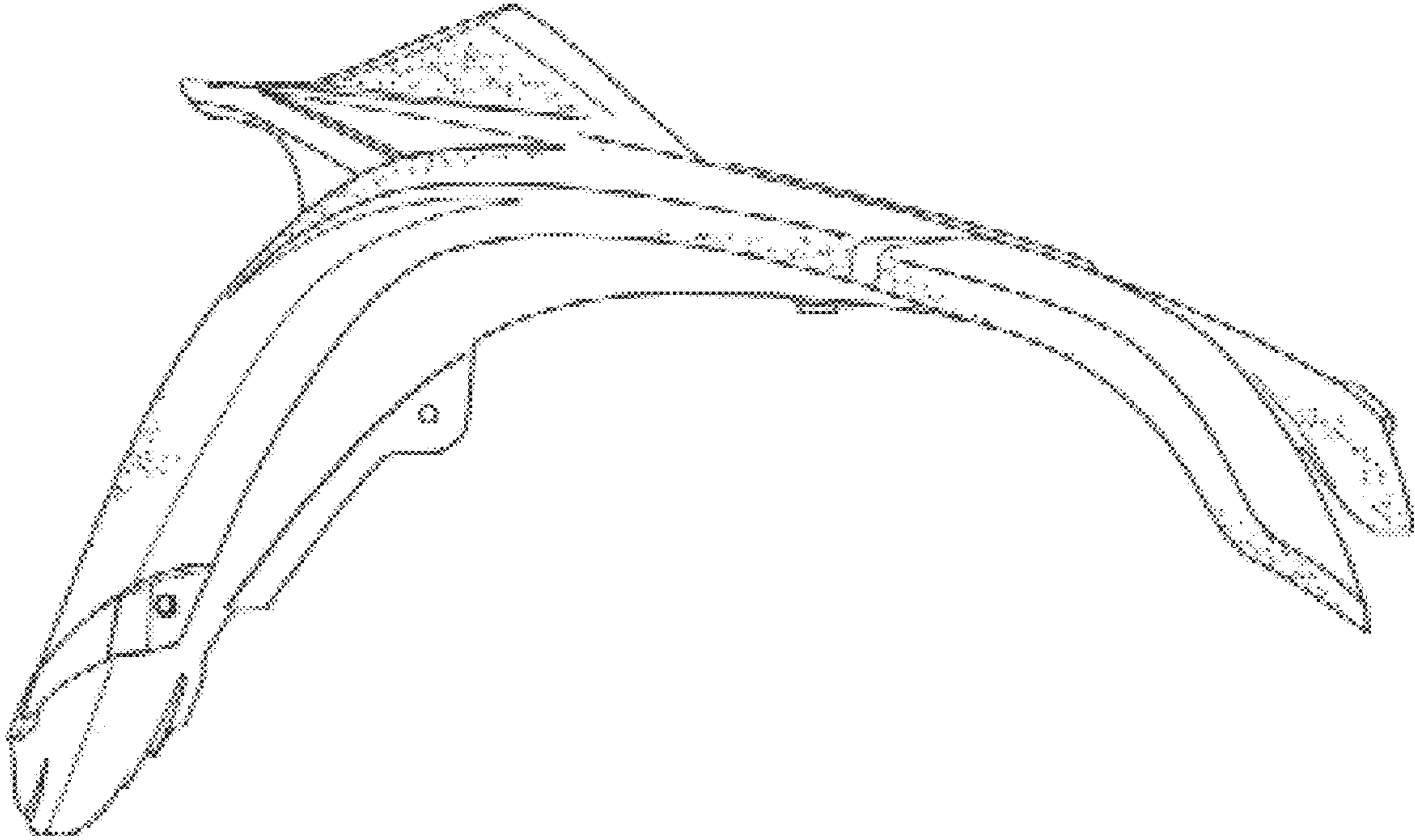

FIG. 9

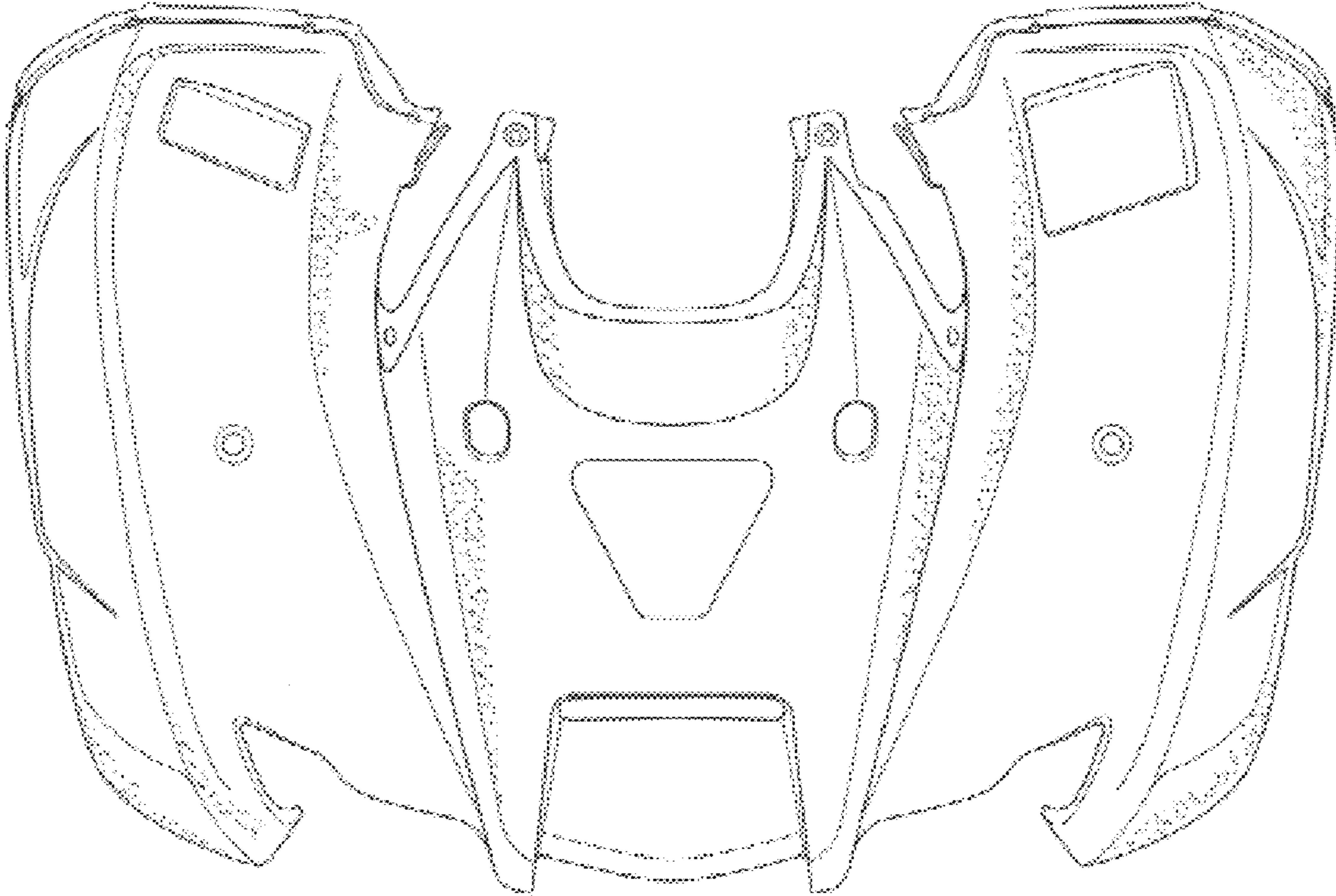

FIG. 10

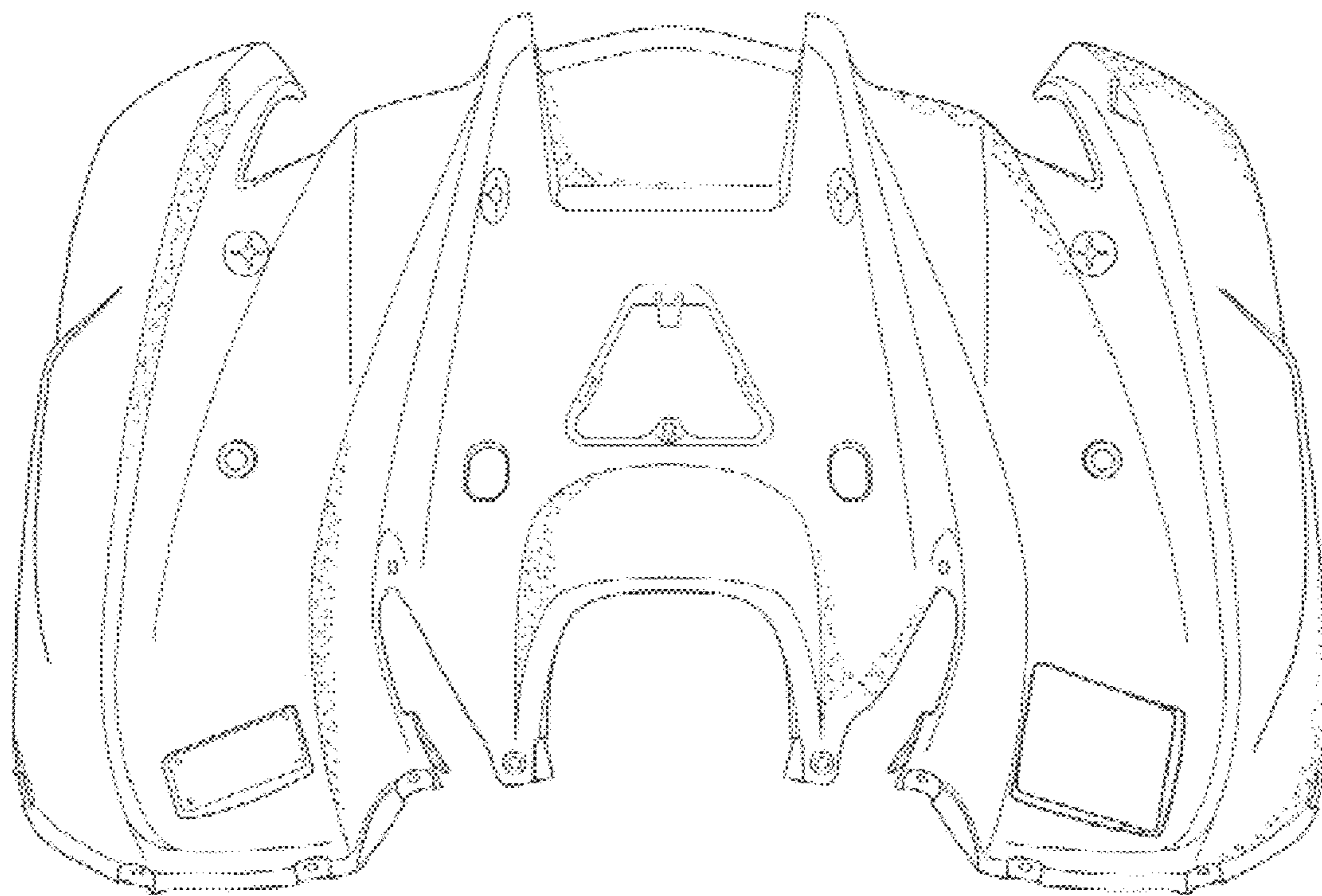
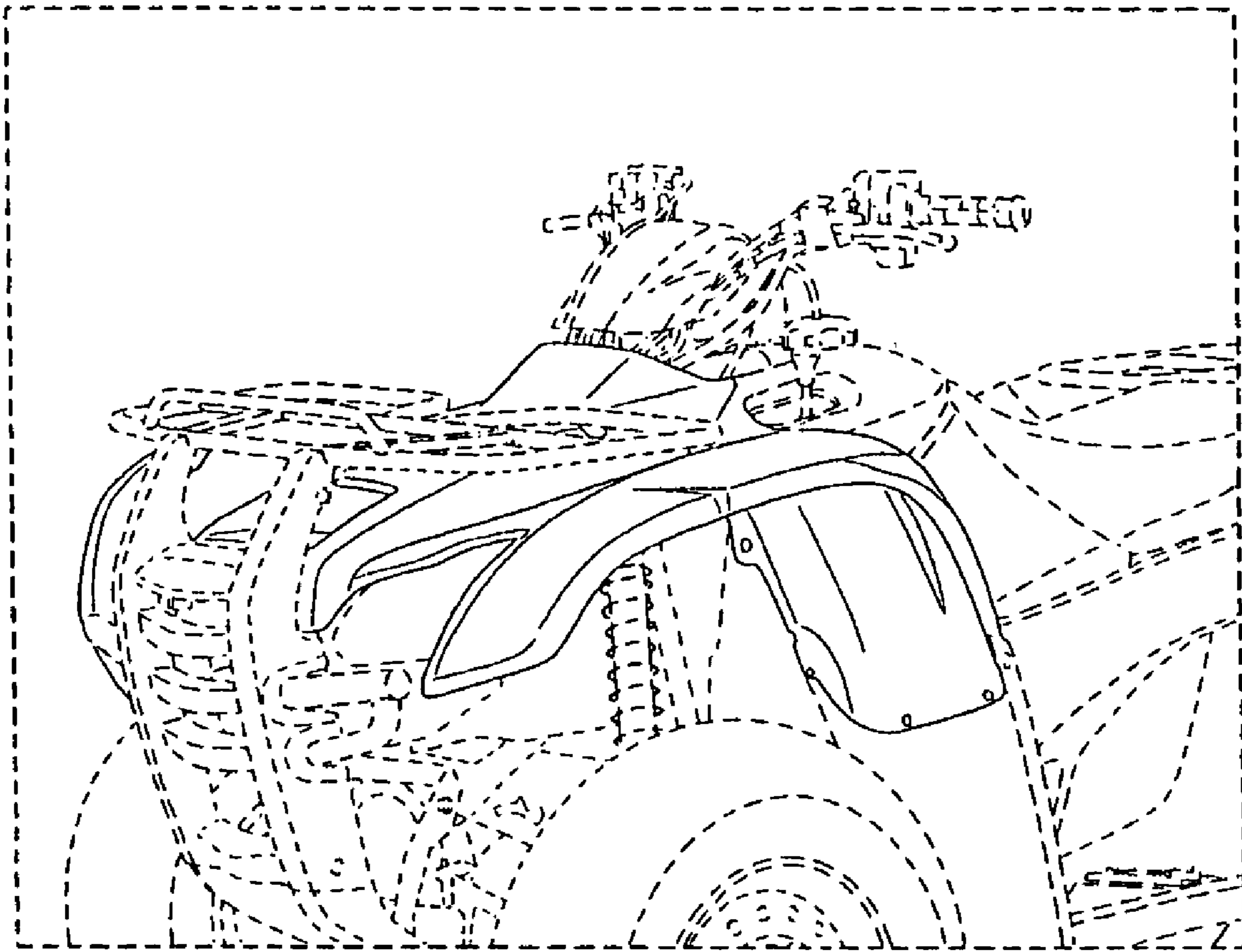

FIG. 11



UNITED STATES PATENT AND TRADEMARK OFFICE
CERTIFICATE OF CORRECTION

PATENT NO. : Des. 562,189 S
APPLICATION NO. : 29/260172
DATED : February 19, 2008
INVENTOR(S) : Miwa et al.

Page 1 of 13

It is certified that error appears in the above-identified patent and that said Letters Patent is hereby corrected as shown below:

The Title Page, showing an illustrative figure, should be **deleted** and **substitute** therefor the attached title page.

Delete drawing sheets 1-11 and **substitute** therefor the drawing sheets consisting of Figs 1-11 as shown on the attached pages.

Signed and Sealed this

Sixteenth Day of December, 2008

A handwritten signature in black ink that reads "Jon W. Dudas". The signature is written in a cursive style with a large, stylized initial "J".

JON W. DUDAS

Director of the United States Patent and Trademark Office

(12) **United States Design Patent** (10) **Patent No.:** **US D562,189 S**
Miwa et al. (45) **Date of Patent:** **** Feb. 19, 2008**

(54) **FRONT COVER FOR FOUR WHEEL VEHICLE**

Primary Examiner—Cathron Brooks
Assistant Examiner—Linda Brooks
 (74) *Attorney, Agent, or Firm*—Birch, Stewart, Kolasch & Birch, LLP

(75) **Inventors:** **Koji Miwa, Wako (JP); Takao Mikami, Wako (JP)**

(73) **Assignee:** **Honda Motor Co., Ltd., Tokyo (JP)**

(57) **CLAIM**

(**) **Term:** **14 Years**

We claim the ornamental design for a front cover for four wheel vehicle, as shown and described.

(21) **Appl. No.:** **29/260,172**

(22) **Filed:** **May 22, 2006**

DESCRIPTION

(30) **Foreign Application Priority Data**

Nov. 22, 2005 (JP) 2005-034278

(51) **LOC (8) Cl.** **12-11**

(52) **U.S. Cl.** **D12/107**

(58) **Field of Classification Search** **D12/3,**
D12/86, 87, 110, 107, 126, 181, 182, 184,
D12/186, 164, 173; 180/225, 229, 233, 311,
180/312, 315; 296/77.1, 78.1, 180.1, 192,
296/193.01, 193.09, 193.11; 280/152.1-152.3,
280/847-852

See application file for complete search history.

(56) **References Cited**

U.S. PATENT DOCUMENTS

7,097,207 B2 * 8/2006 Kudo et al. 280/848

FOREIGN PATENT DOCUMENTS

JP 1179663 7/2003

* cited by examiner

FIG. 1 is a perspective view from the front side of a front cover for four wheel vehicle.

FIG. 2 is a perspective view from the front side thereof.

FIG. 3 is a perspective view from the rear side thereof.

FIG. 4 is a perspective view from the rear side thereof.

FIG. 5 is a front elevation view thereof.

FIG. 6 is a rear elevation view thereof.

FIG. 7 is a right side elevation view thereof.

FIG. 8 is a left side elevation view thereof.

FIG. 9 is a top plan view thereof.

FIG. 10 is a bottom plan view thereof; and,

FIG. 11 is a perspective view thereof and reduced scale and shown in condition of use.

The broken lines shown in the drawings are for illustrative purposes only and form no part of the claimed design.

1 Claim, 11 Drawing Sheets

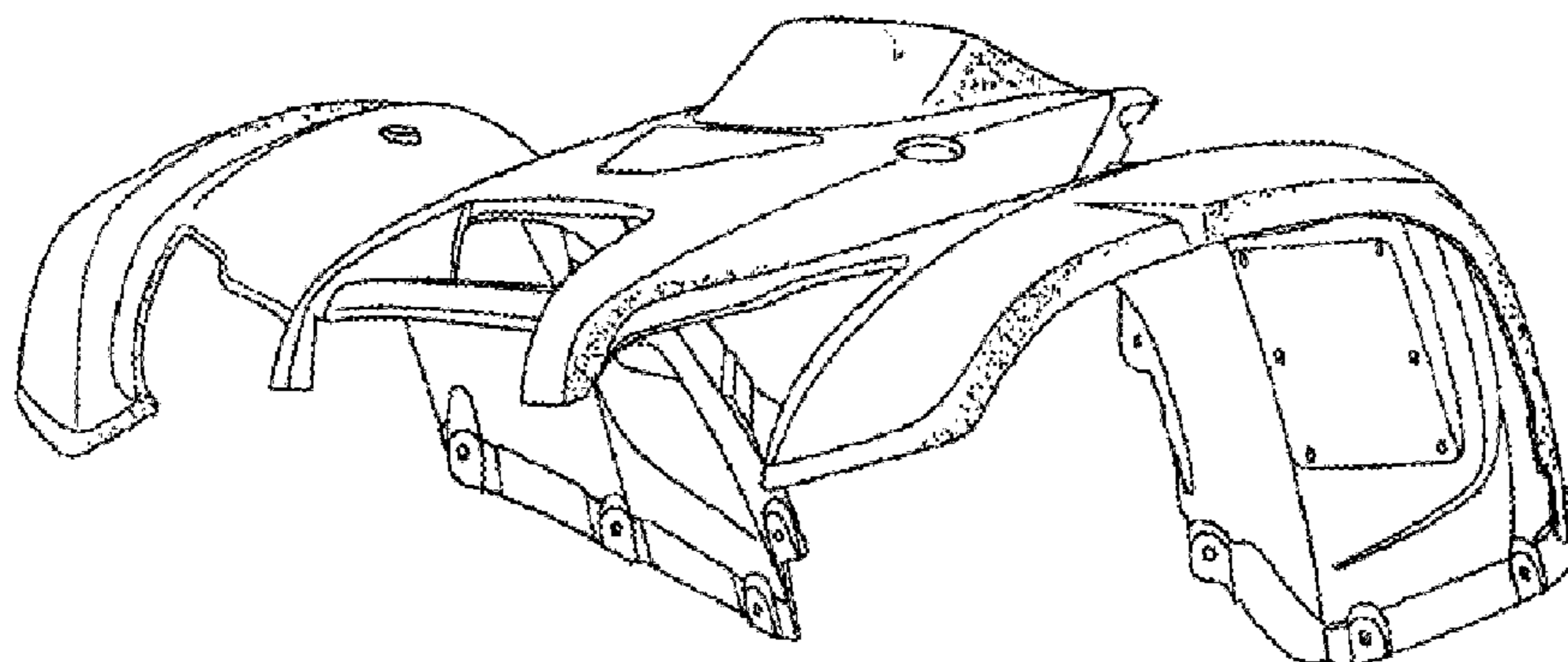

U.S. Patent

Feb. 19, 2008

Sheet 1 of 11

D562,189 S

FIG. 1

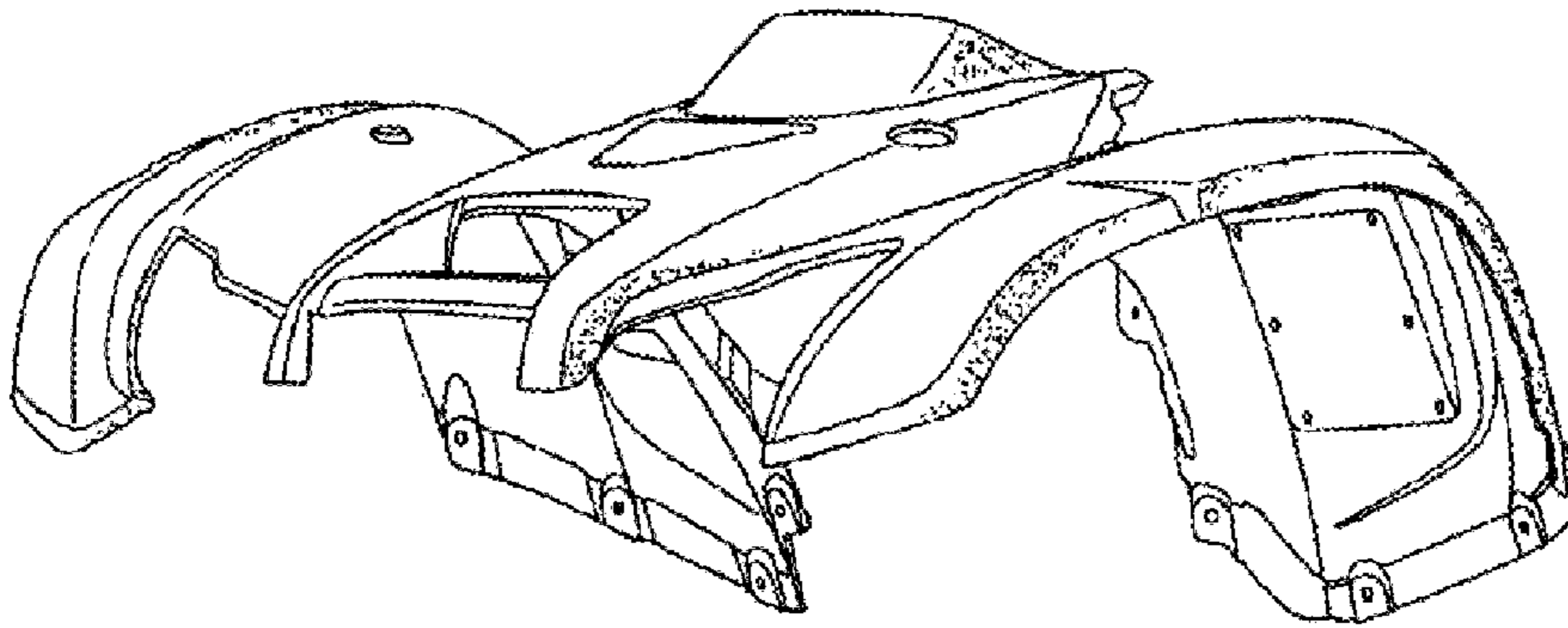

FIG. 2

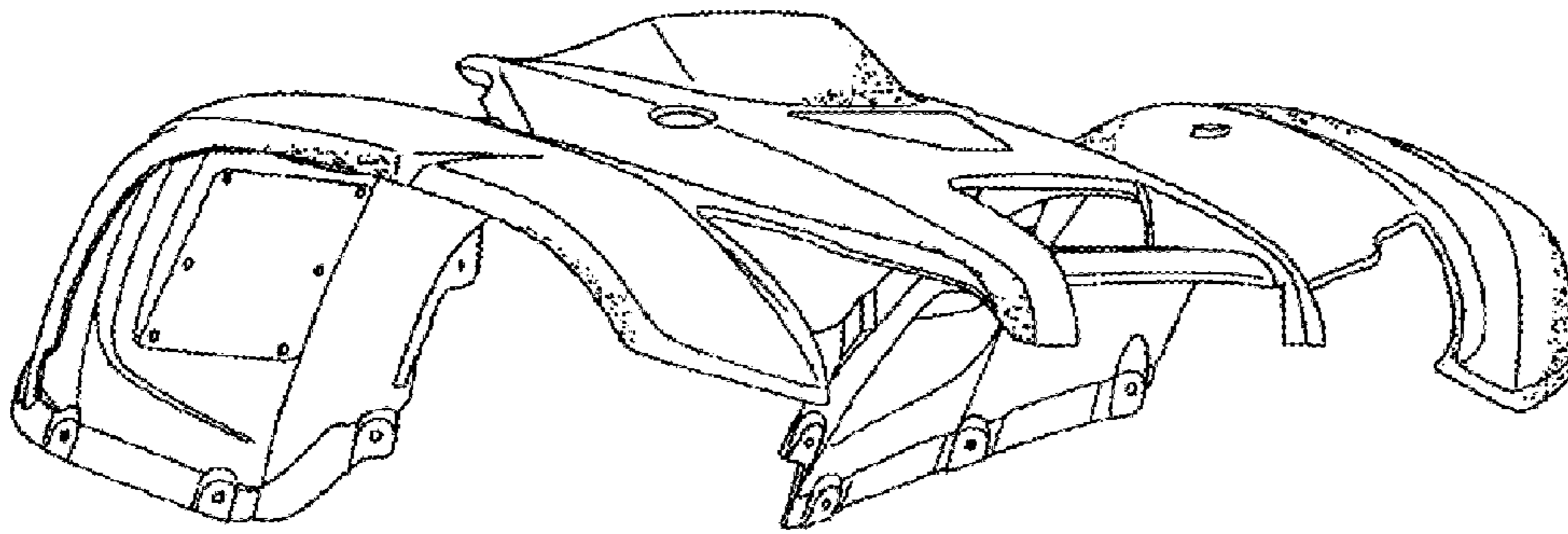

FIG. 3

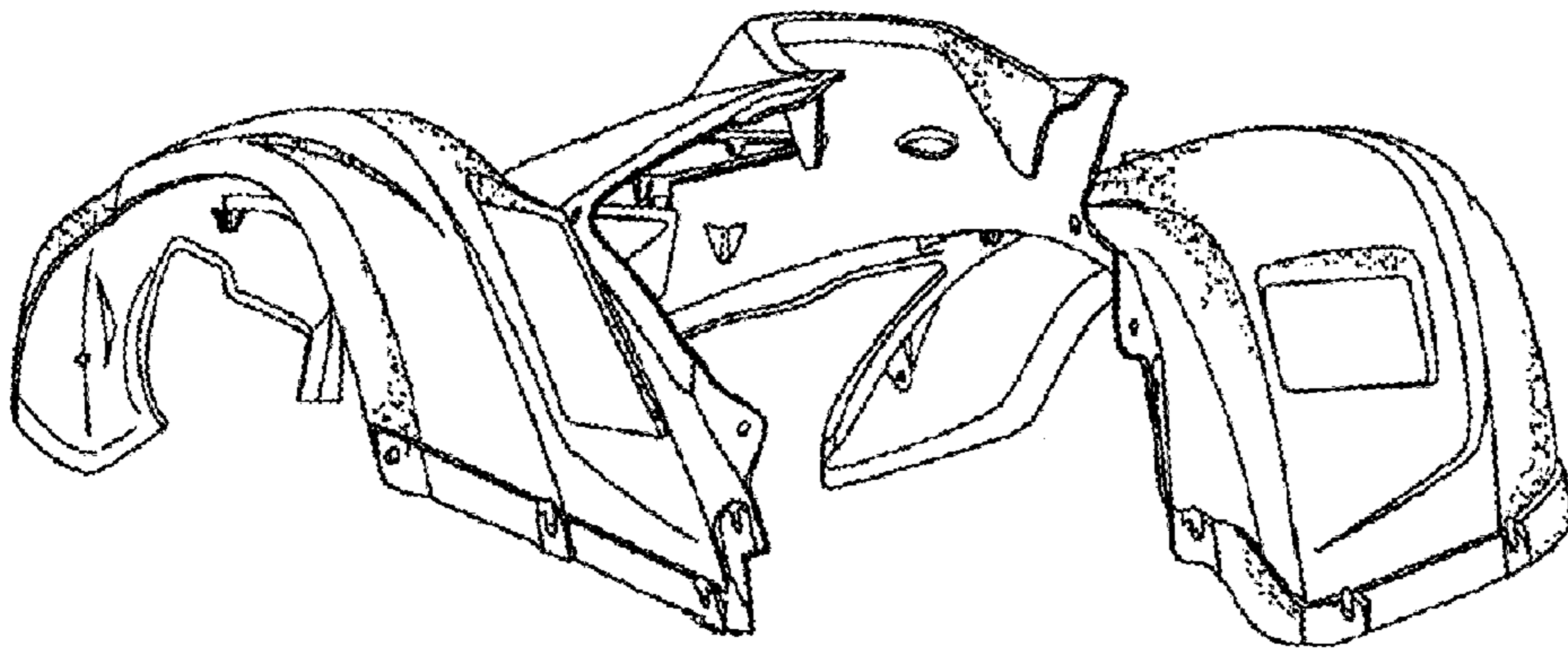

FIG. 4

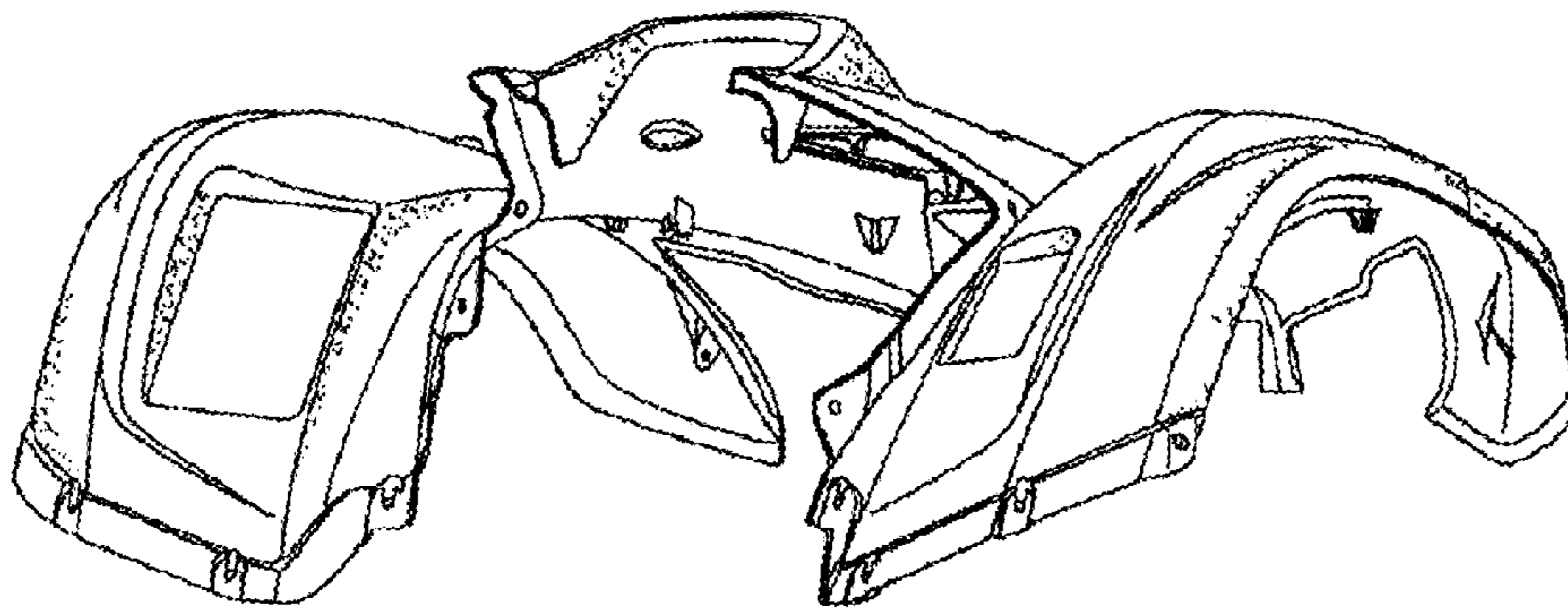

FIG. 5

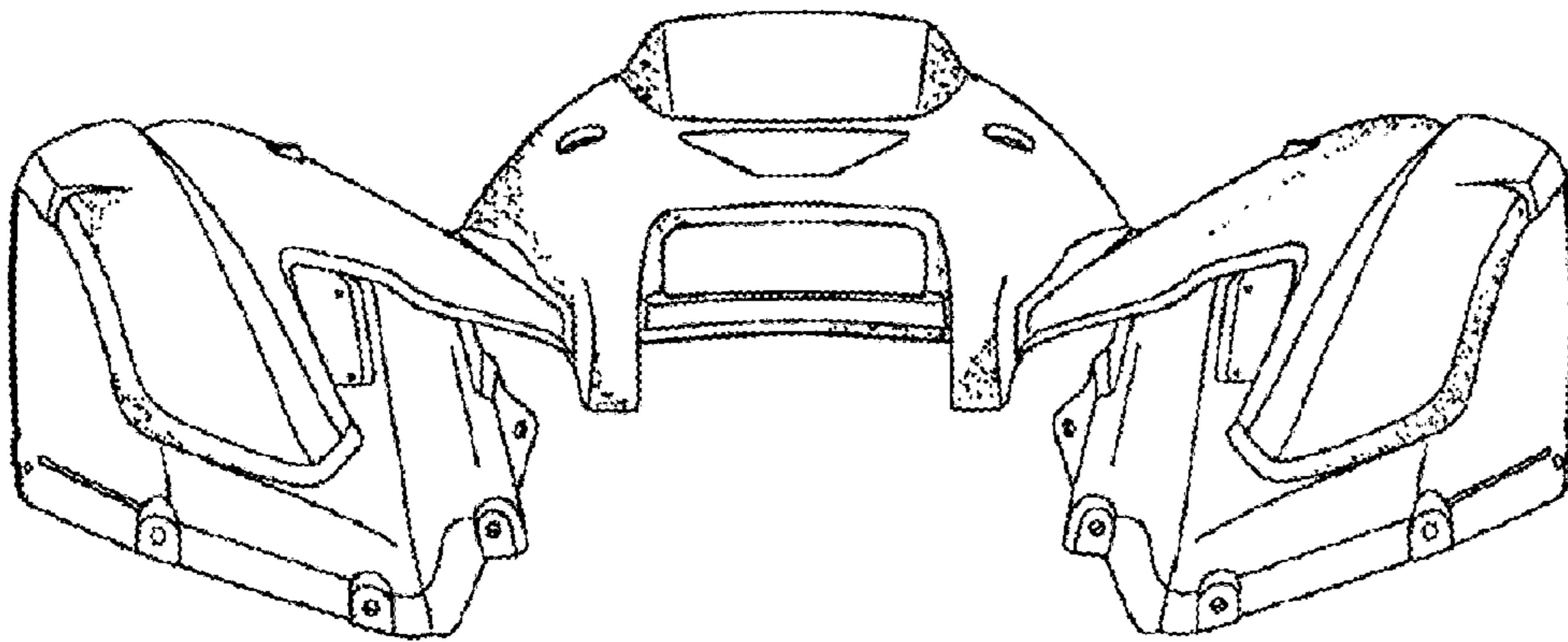

FIG. 6

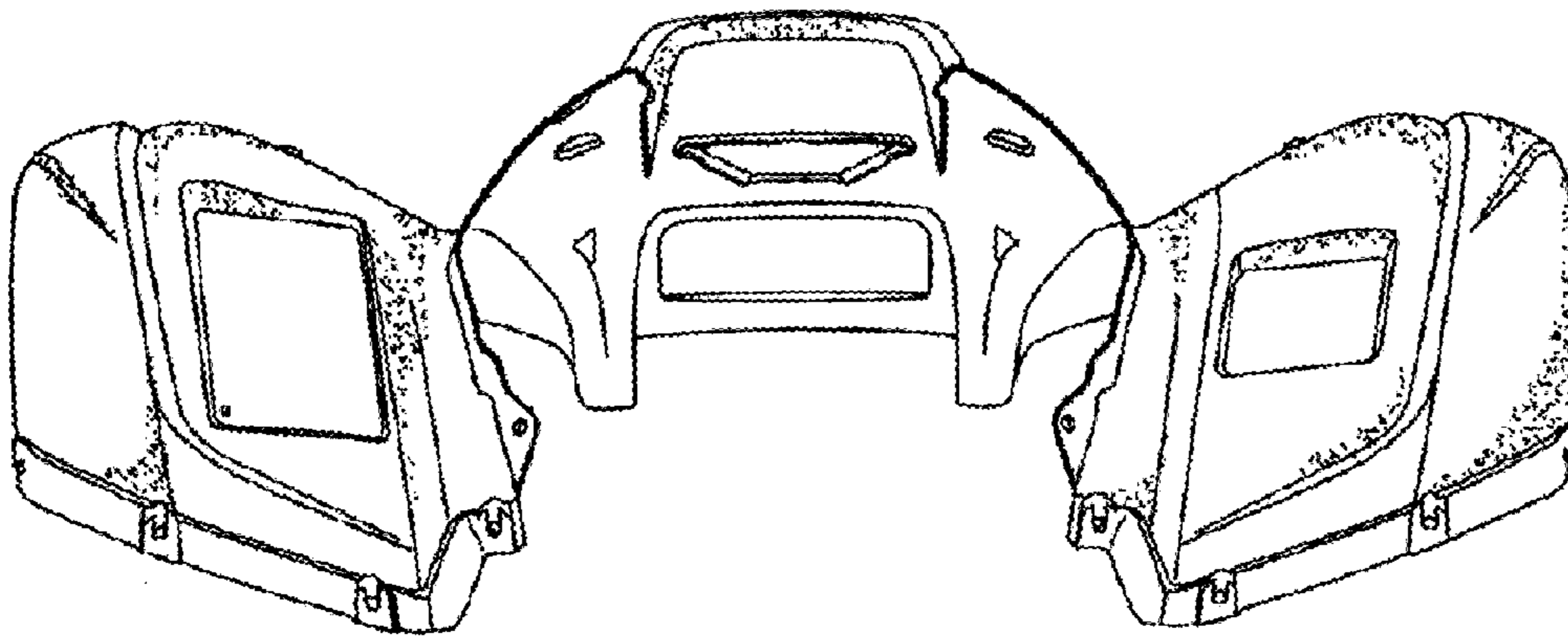

FIG. 7

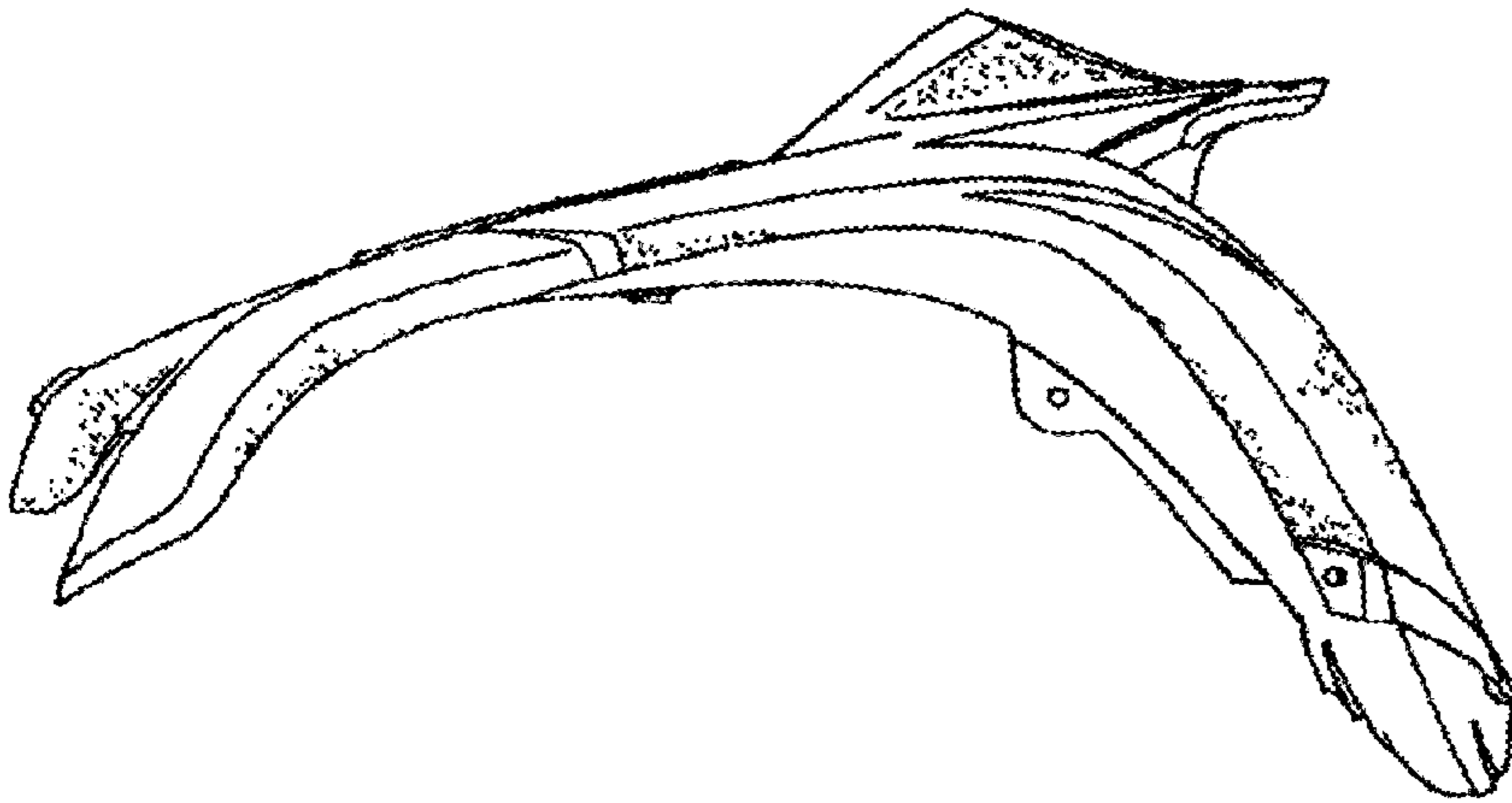

FIG. 8

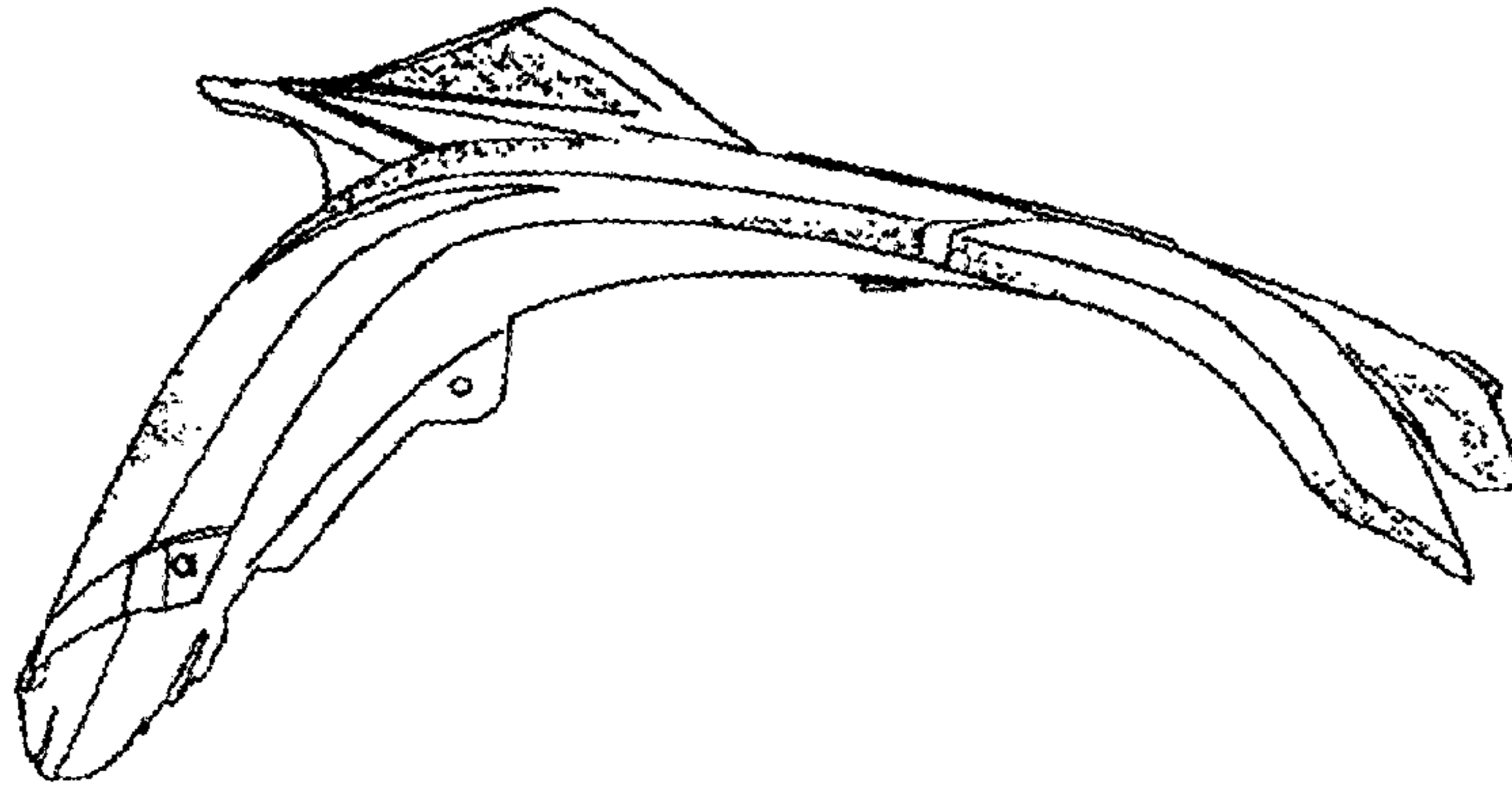

FIG. 9

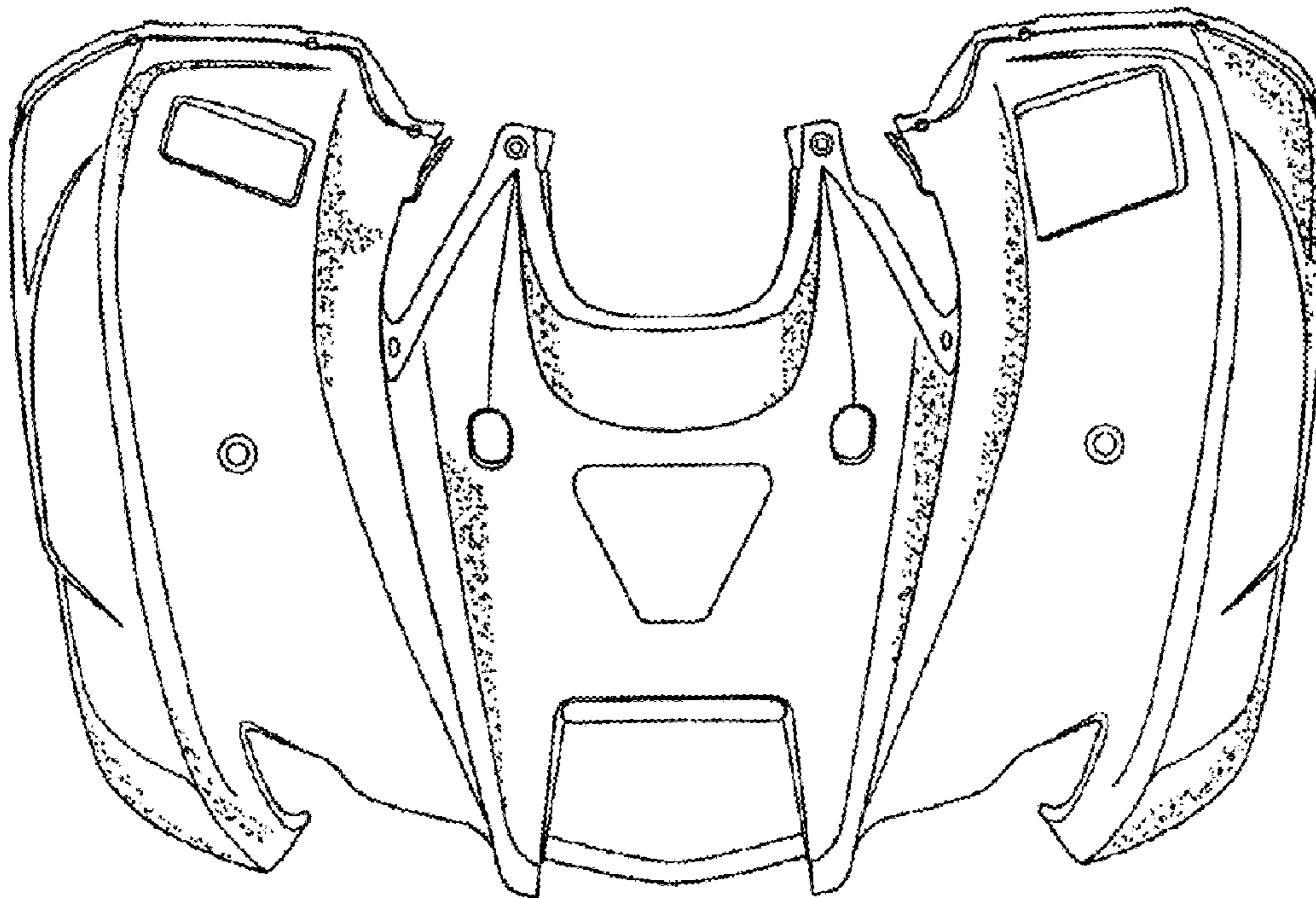

FIG. 10

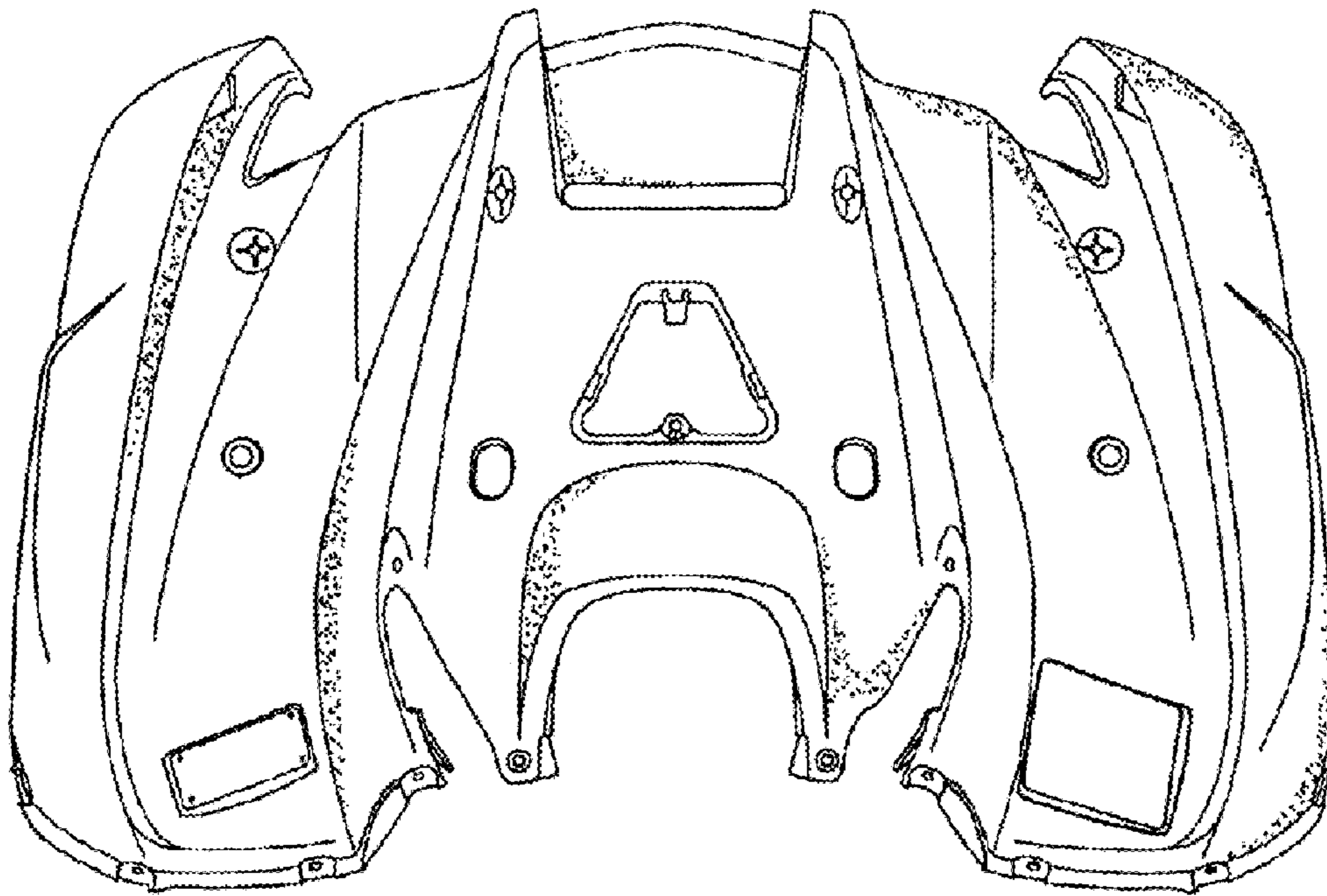

FIG. 11

