

US00D562111S

(12) **United States Design Patent**
Krumpe et al.

(10) **Patent No.:** **US D562,111 S**

(45) **Date of Patent:** **** Feb. 19, 2008**

(54) **WALL PLATE**

(75) Inventors: **Geraint Krumpe**, Chicago, IL (US);
Victor Hoernig, Lowell, IN (US)

(73) Assignee: **Liberty Hardware Mfg. Corp.**,
Winston-Salem, NC (US)

(**) Term: **14 Years**

(21) Appl. No.: **29/262,930**

(22) Filed: **Jul. 13, 2006**

(51) **LOC (8) Cl.** **11-05**

(52) **U.S. Cl.** **D8/350**

(58) **Field of Classification Search** D8/350-353;
D10/108, 123, 125; D13/156, 158, 162,
D13/169, 171, 174, 177, 184; 200/304, 330;
250/462.1; 220/241; 174/66, 67

See application file for complete search history.

(56) **References Cited**

U.S. PATENT DOCUMENTS

D113,557 S *	2/1939	Fordyce	D8/350
D154,834 S *	8/1949	Bellek	D8/350
D222,885 S *	1/1972	Smith	D8/353
D476,549 S *	7/2003	Shaw	D8/353
7,098,403 B2 *	8/2006	Jolley	174/67

* cited by examiner

Primary Examiner—Stella M. Reid
Assistant Examiner—Mark Goodwin

(74) *Attorney, Agent, or Firm*—Edgar A. Zarins; Lloyd D. Doigan

(57) **CLAIM**

The ornamental design for a wall plate, as shown and described.

DESCRIPTION

FIG. 1 is a perspective view of a wall plate showing our new design;

FIG. 2 is a front elevational view thereof;

FIG. 3 is an end view thereof, the opposite end being a mirror image of the side shown;

FIG. 4 is a cross-sectional view thereof taken along line 4—4 of FIG. 2;

FIG. 5 is a side view thereof, the opposite side being a mirror image of the side shown;

FIG. 6 is a perspective view of a second embodiment thereof;

FIG. 7 is a perspective view of a third embodiment thereof; and,

FIG. 8 is a perspective view of a fourth embodiment thereof.

All views of the claim not shown form no part of the claimed design.

The broken line showing of the screw holes in FIGS. 1, 2, and 6-8 is included for the purpose of illustrating environmental structure and forms no part of the claimed design.

1 Claim, 3 Drawing Sheets

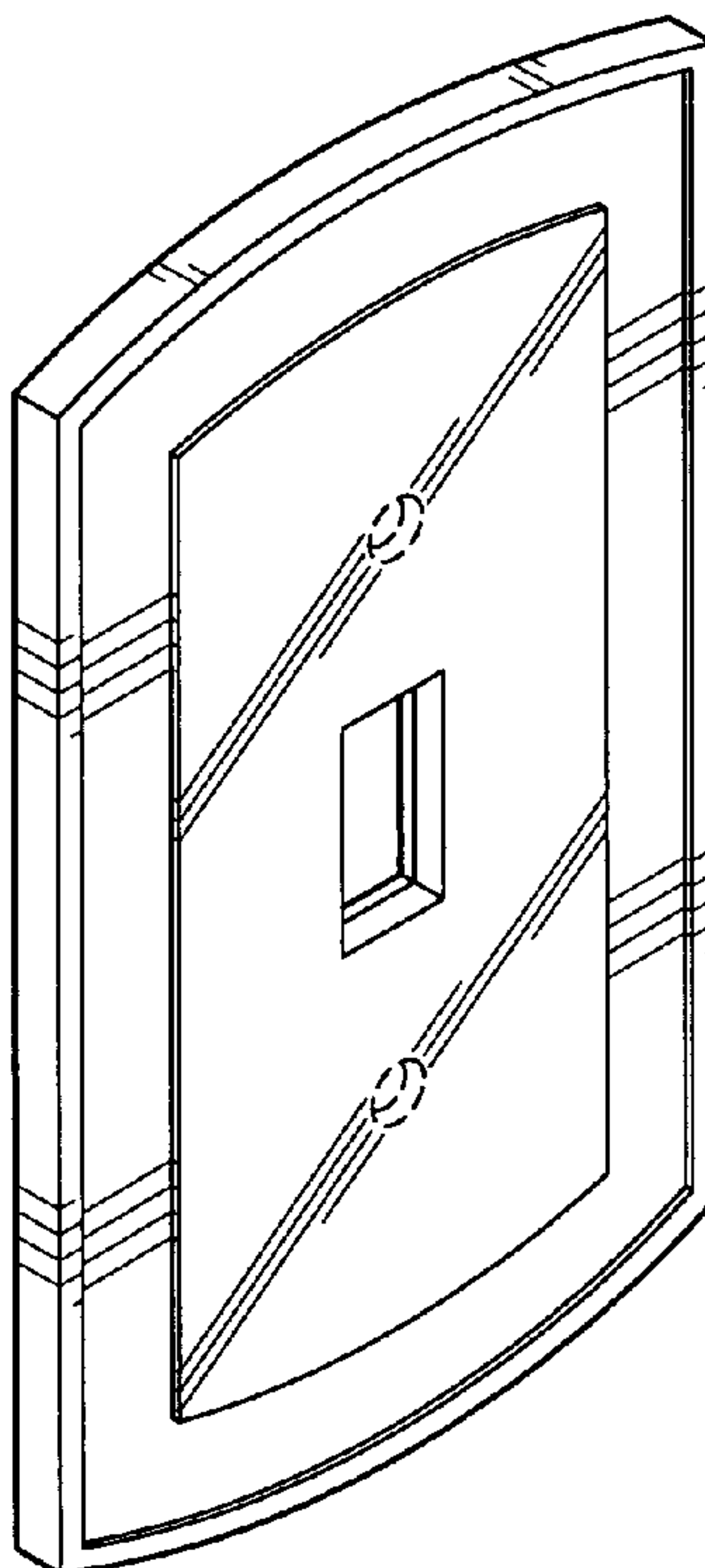

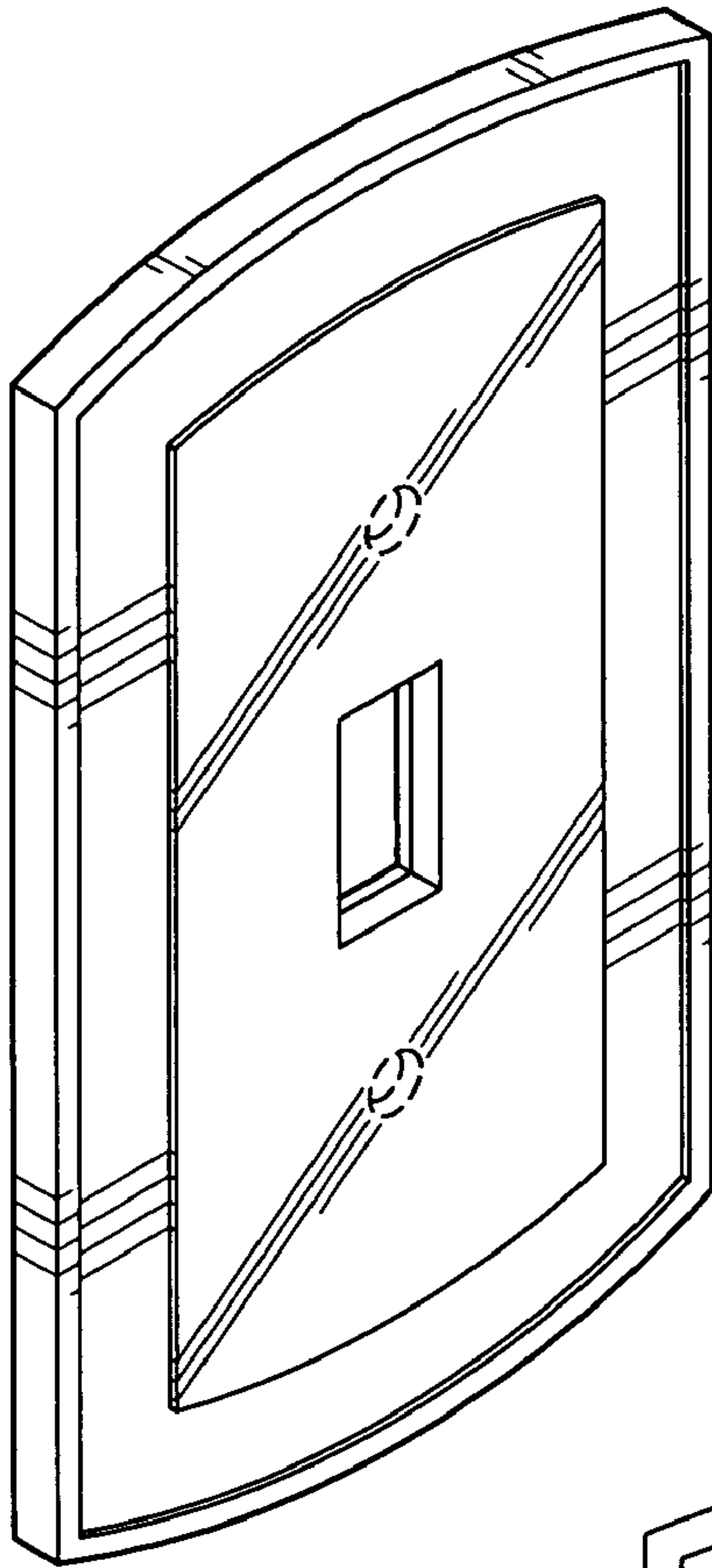

Fig-1

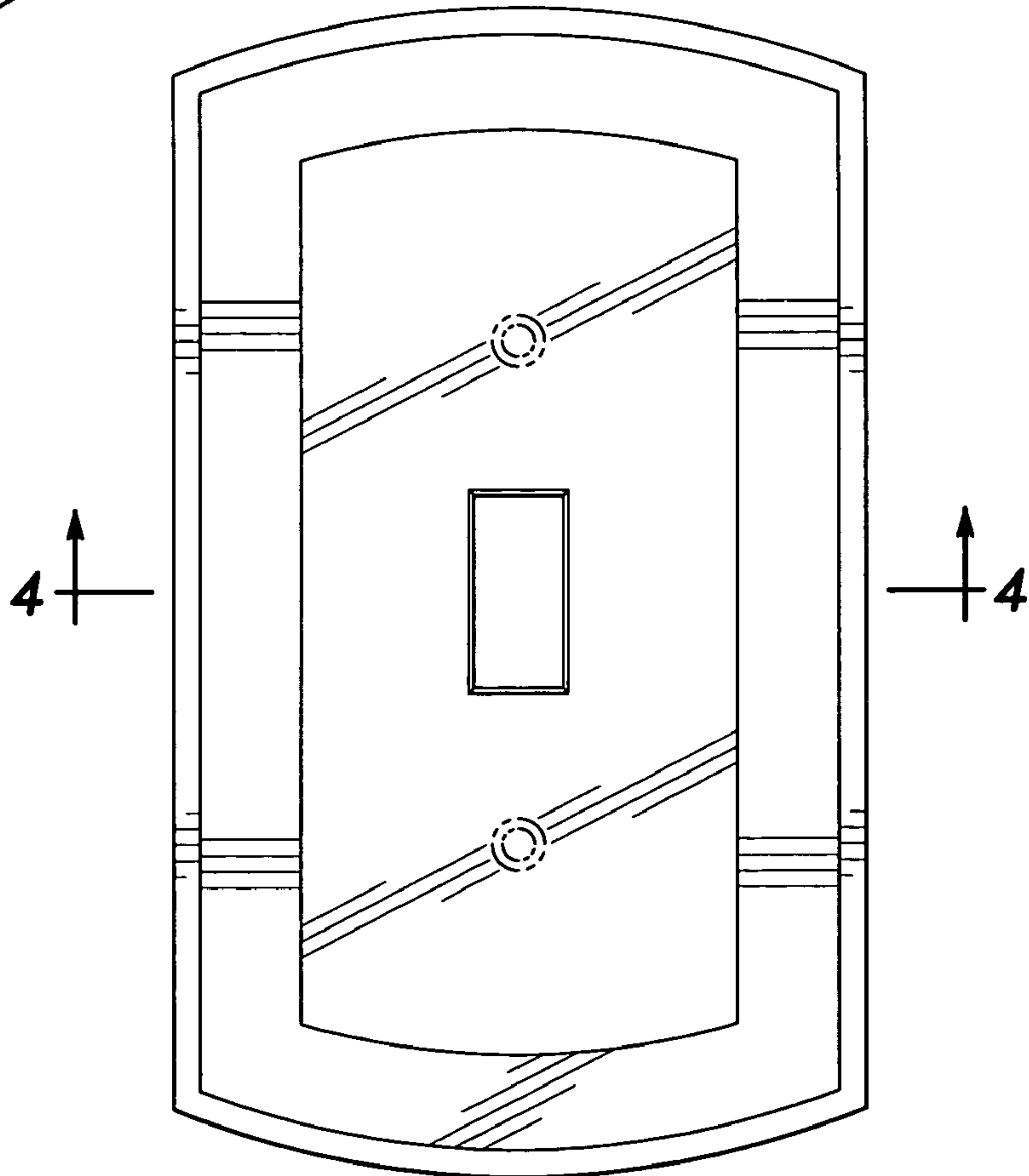

Fig-2



Fig-3

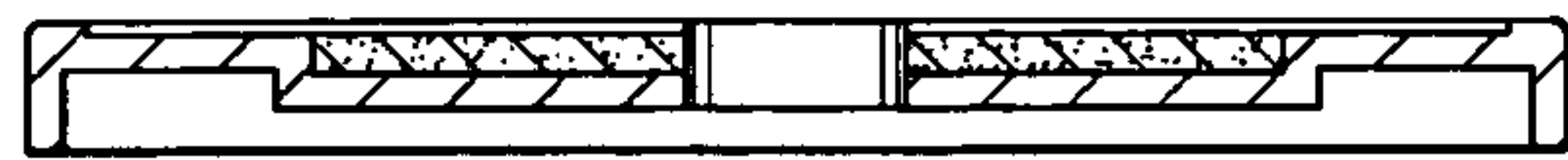

Fig-4



Fig-5

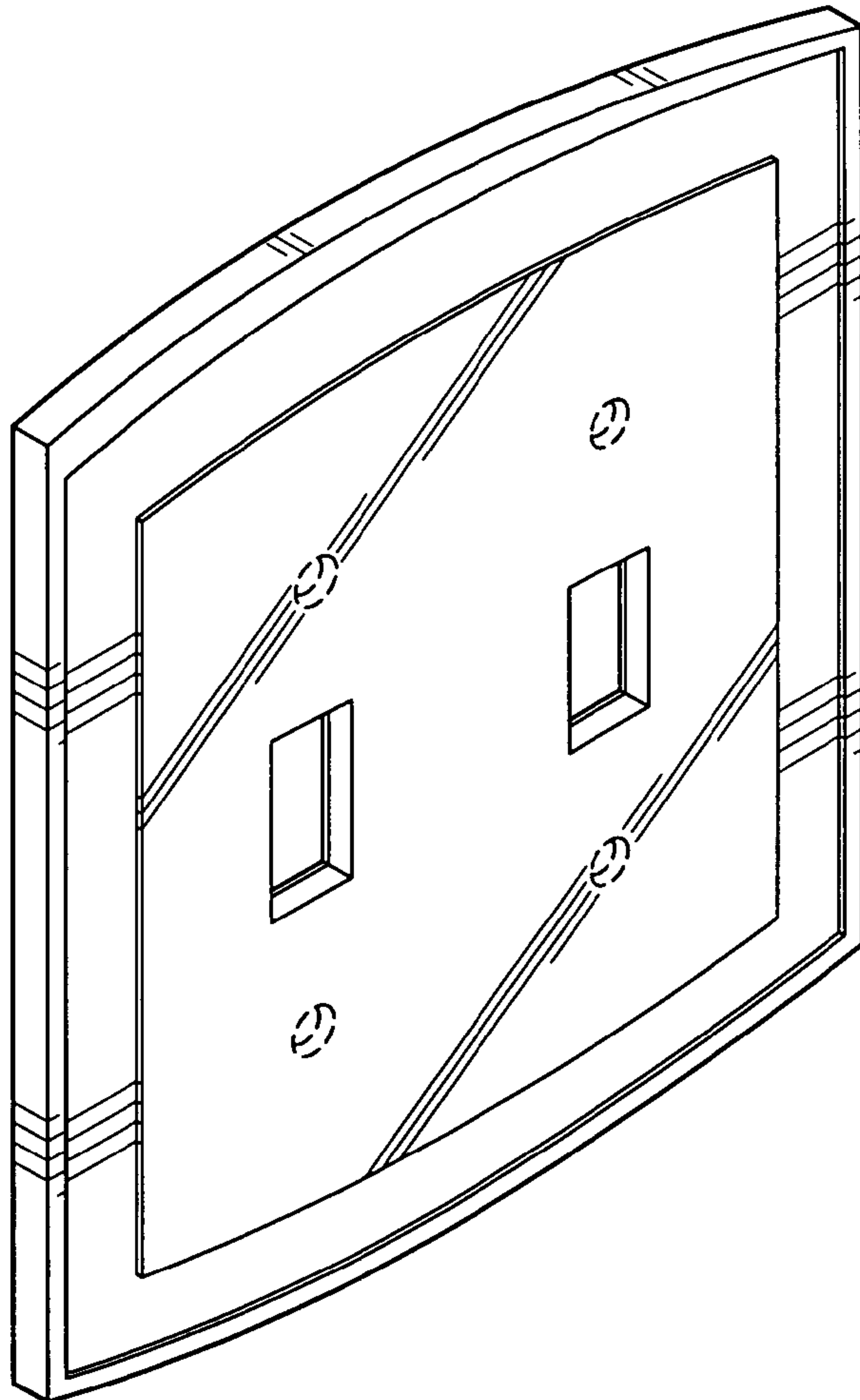

Fig-6

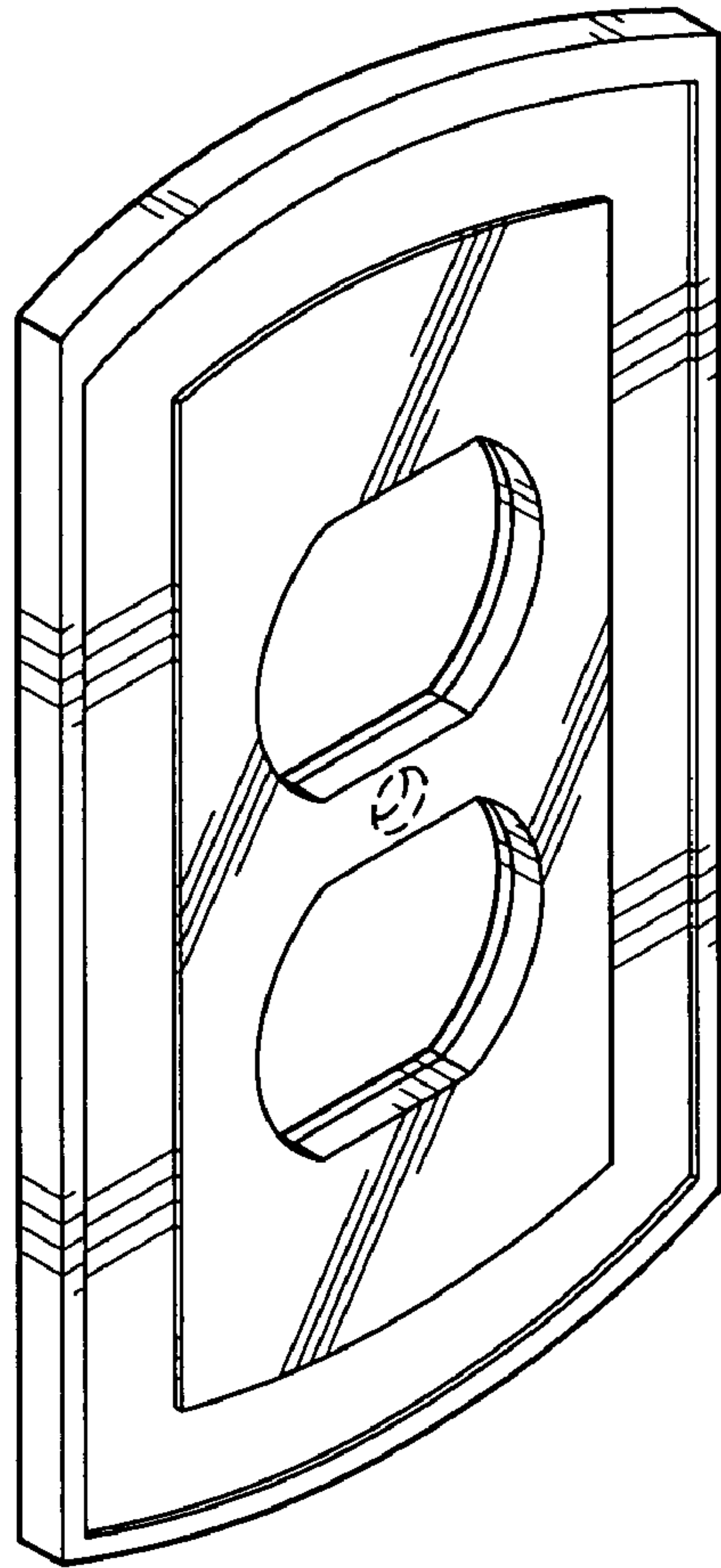

Fig-7

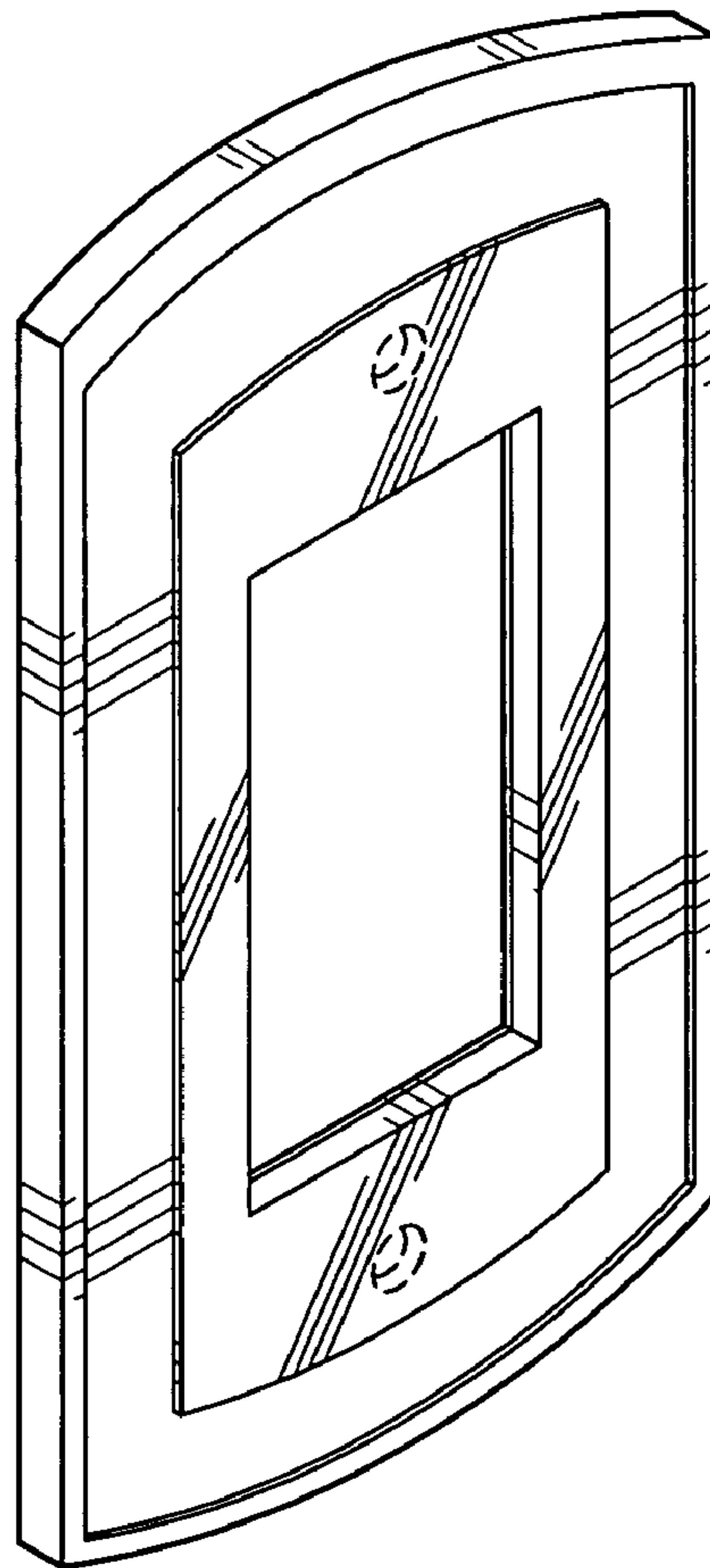

Fig-8