



US00D562109S

(12) **United States Design Patent**  
**Liang**

(10) **Patent No.:** **US D562,109 S**  
(45) **Date of Patent:** **\*\* Feb. 19, 2008**

(54) **SASH LOCK**

(57) **CLAIM**

(76) Inventor: **Luke Liang**, 30 Spruce Hollow Rd.,  
Green Brook, NJ (US) 08812

The ornamental design for a sash lock, as shown and described.

(\*\*) Term: **14 Years**

**DESCRIPTION**

(21) Appl. No.: **29/289,058**

FIG. 1 is a top view of the present invention where the hood of the sash lock covers the keeper.

(22) Filed: **Jul. 3, 2007**

FIG. 2 is a front view of the sash lock of the present invention showing the lock and keeper.

**Related U.S. Application Data**

FIG. 3 is a bottom view of the sash lock of FIG. 1.

(62) Division of application No. 29/223,091, filed on Feb. 7, 2005, now Pat. No. Des. 546,166.

FIG. 4 is a rear view of the sash lock of FIG. 1.

(51) **LOC (8) Cl.** ..... **08-07**

FIG. 5 is a left side view of the sash lock of FIG. 1.

(52) **U.S. Cl.** ..... **D8/337**

FIG. 6 is a right side view of the sash lock of FIG. 1.

(58) **Field of Classification Search** ..... 292/241,  
292/242, 111, 83, 85; 70/89, 90; D8/330-348  
See application file for complete search history.

FIG. 7 is a rear perspective view of the sash lock of FIG. 1.

FIG. 8 is a front perspective view of the sash lock of FIG. 1.

(56) **References Cited**

FIGS. 9A and B are top views of an alternative embodiment of the sash lock and keeper of the present invention where hood of the sash lock does not cover the keeper.

**U.S. PATENT DOCUMENTS**

FIG. 10A is a front view of the sash lock of FIG. 9A

D293,548 S *	1/1988	Bates et al. ....	D8/337
D380,957 S *	7/1997	Evans et al. ....	D8/337
D382,191 S *	8/1997	Plummer .....	D8/337
D382,192 S *	8/1997	Plummer .....	D8/337
D408,263 S *	4/1999	Briggs .....	D8/337
D418,737 S *	1/2000	Libby et al. ....	D8/337
6,871,886 B2 *	3/2005	Coleman et al. ....	292/241
7,000,957 B2 *	2/2006	Lawrence .....	292/241
D527,613 S *	9/2006	Omangi et al. ....	D8/331
7,159,908 B2 *	1/2007	Liang .....	292/242
D546,166 S *	7/2007	Liang .....	D8/344
2001/0005995 A1 *	7/2001	Subliskey .....	70/89

FIG. 10B is a front view of the sash lock of FIG. 9B.

FIG. 11A is a bottom view of the sash lock of FIG. 9A

FIG. 11B is a bottom view of the sash lock of FIG. 9B

FIG. 12A is an end view of the sash lock of FIG. 9A.

FIG. 12B is an end view of the sash lock of FIG. 9B.

FIG. 13A is a left side view of the sash lock of FIG. 9A.

FIG. 13B is a left side view of the sash lock of FIG. 9B.

FIG. 14A is a right side view of the sash lock of FIG. 9A.

FIG. 14B is a right side view of the keeper of FIG. 9B.

\* cited by examiner

FIG. 15A is a perspective view of the sash lock of FIG. 9A; and,

FIG. 15B is a perspective view of the keeper of FIG. 9B.

*Primary Examiner*—Mitchell Siegel

(74) *Attorney, Agent, or Firm*—Thomas A. O'Rourke;  
Bodner & O'Rourke, LLP

**1 Claim, 5 Drawing Sheets**

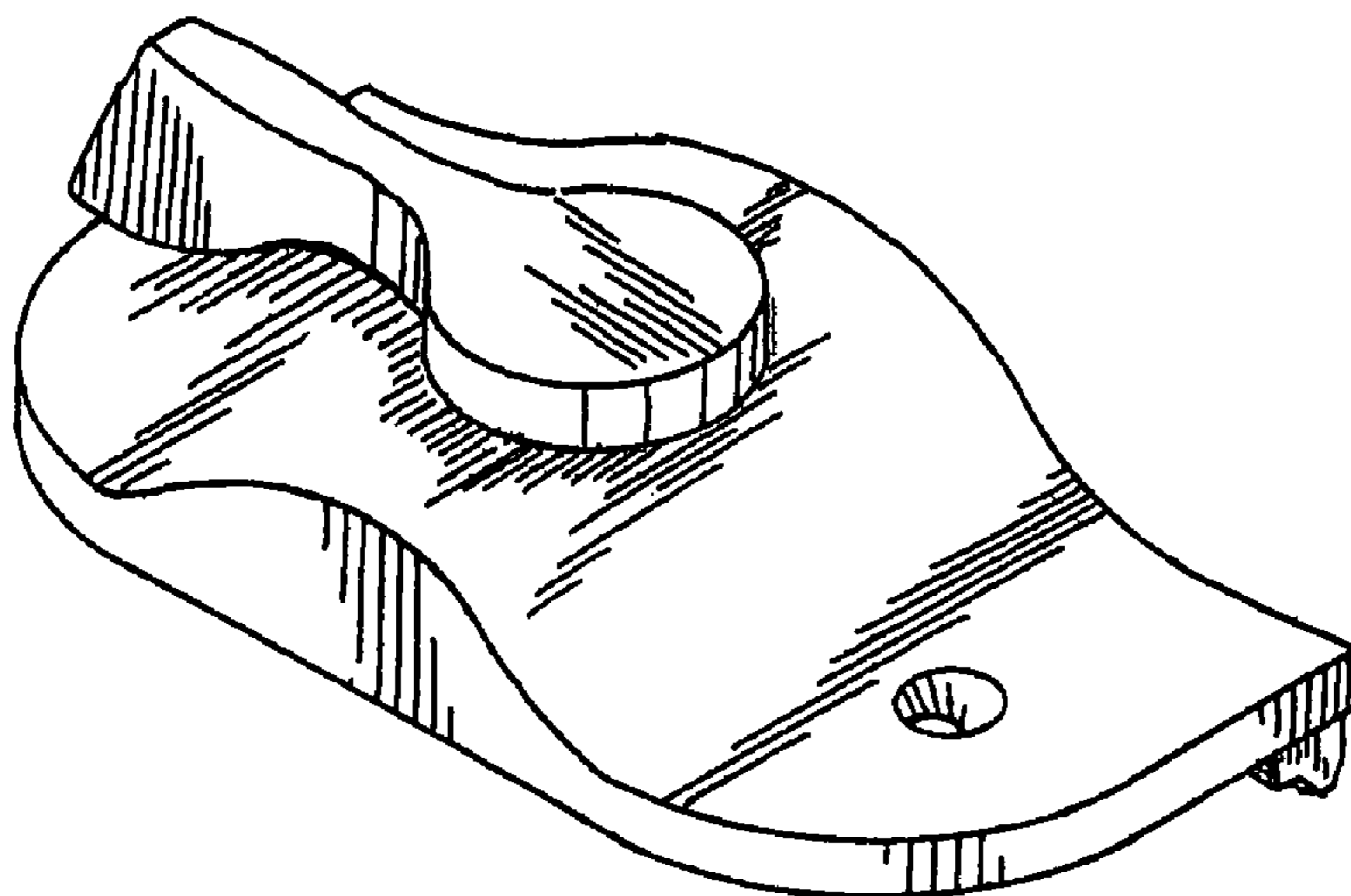

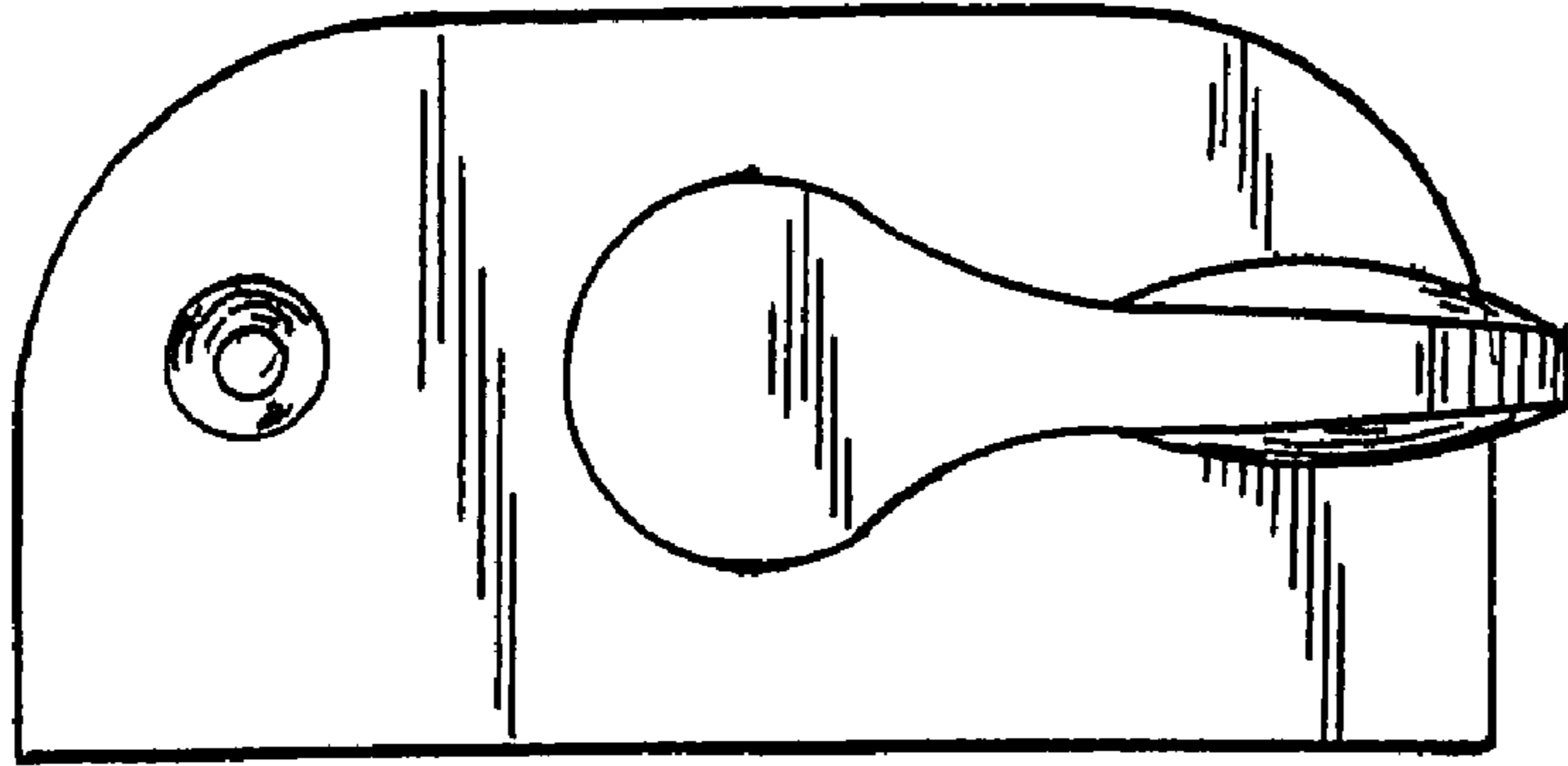

FIG. 1

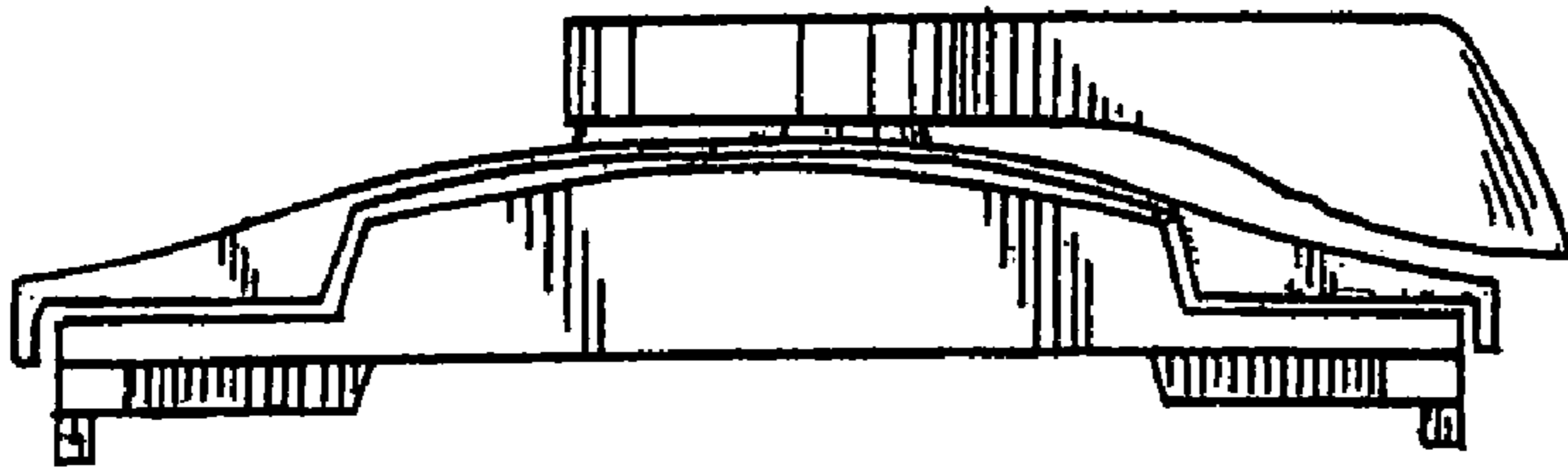

FIG. 2

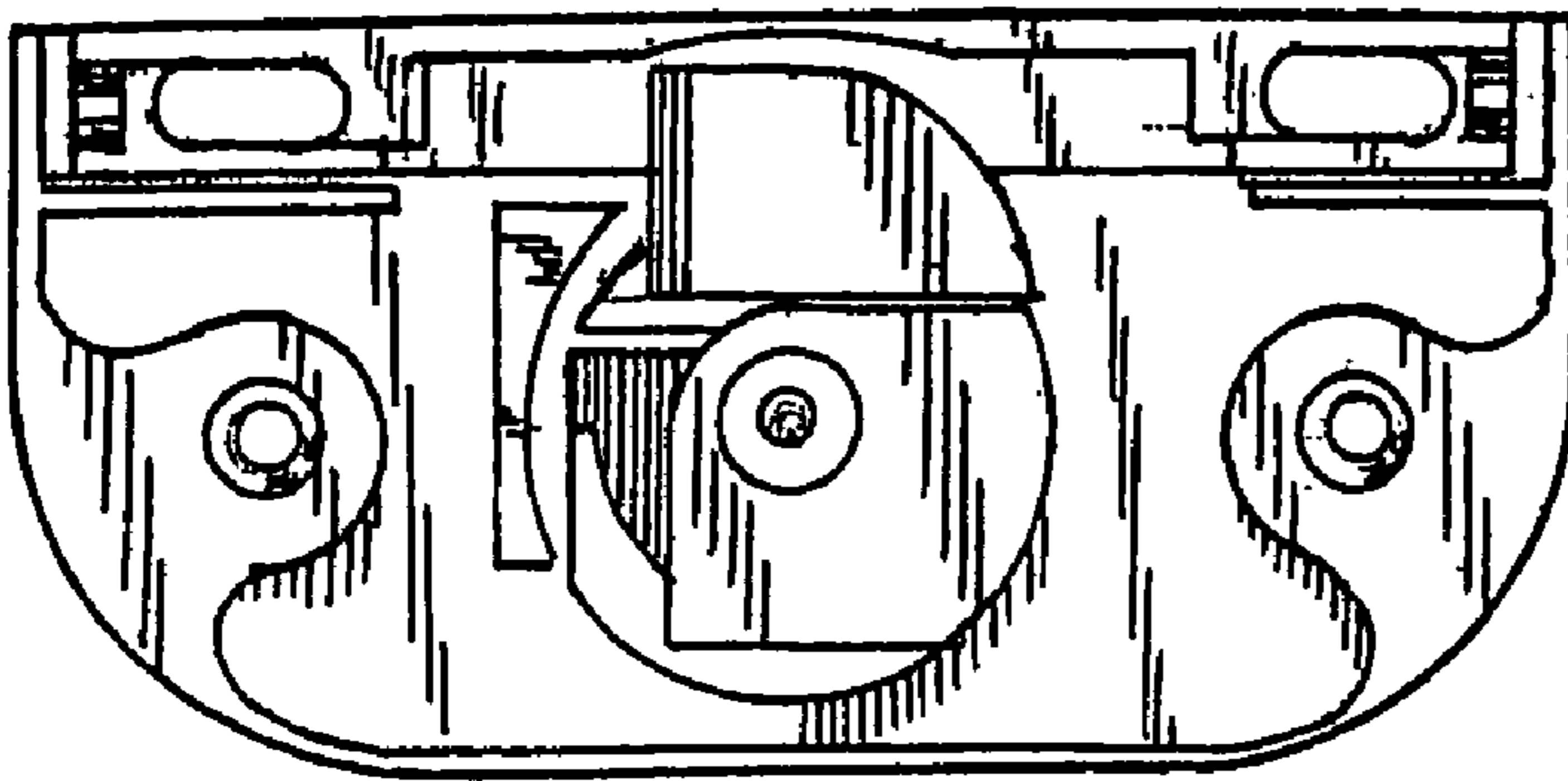

FIG. 3

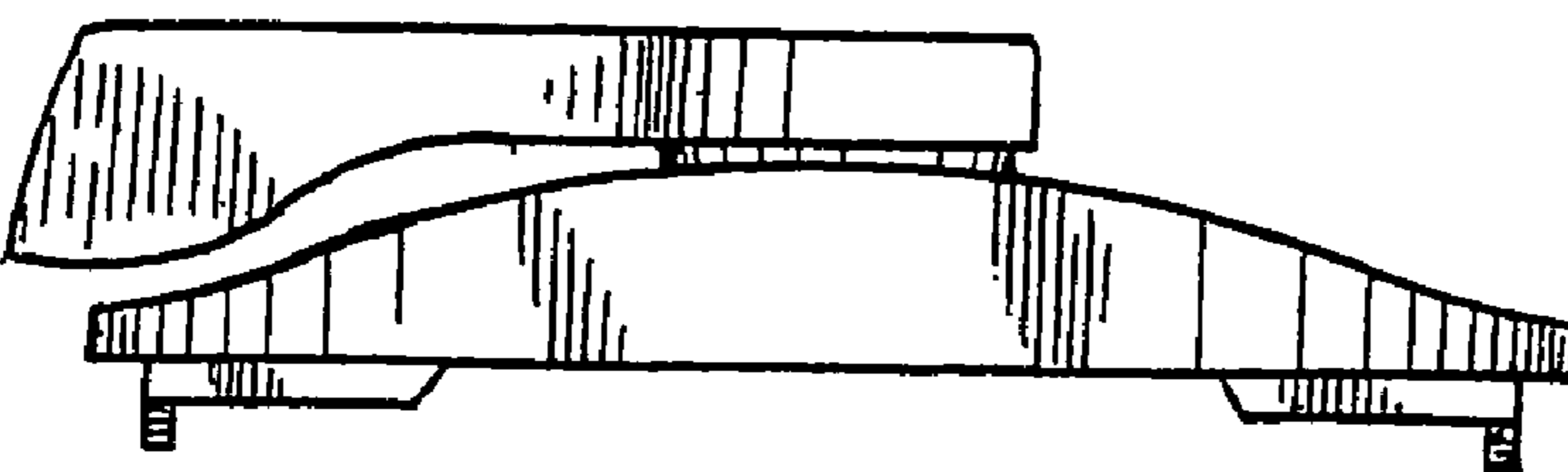

FIG. 4

FIG. 5

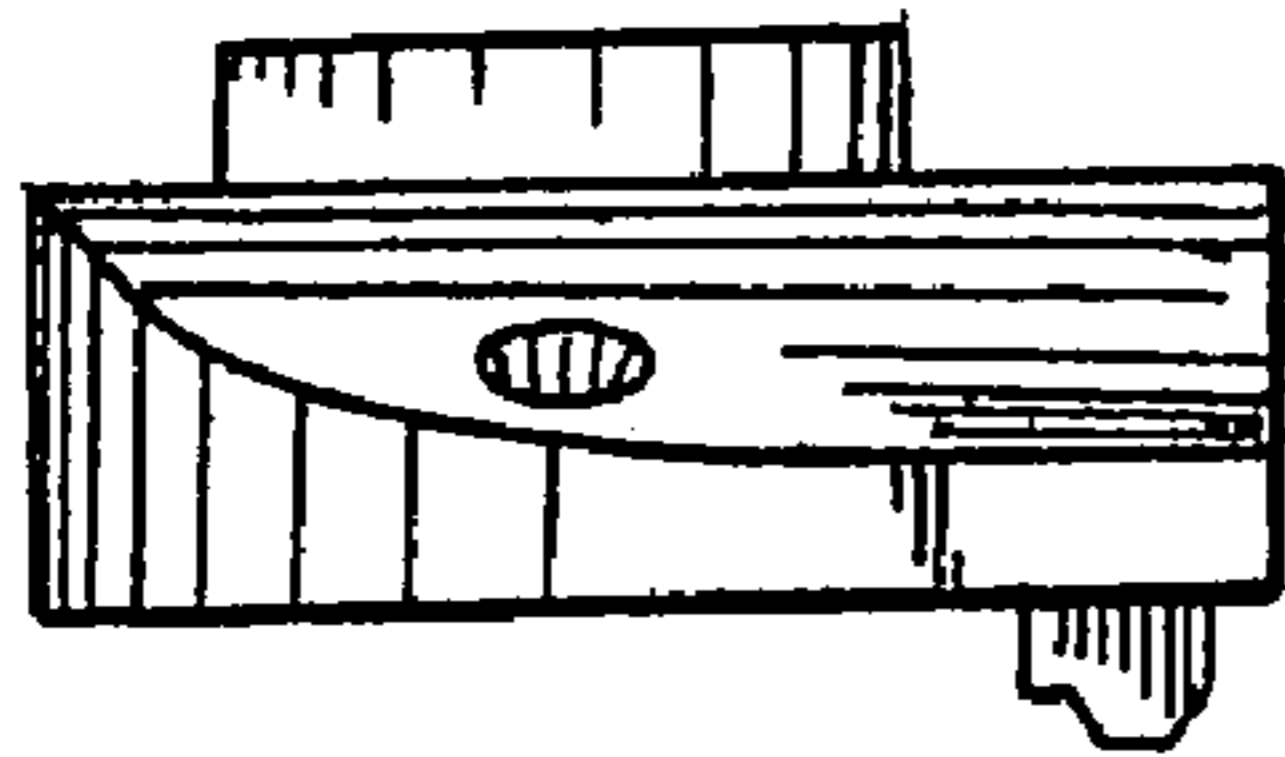

FIG. 6

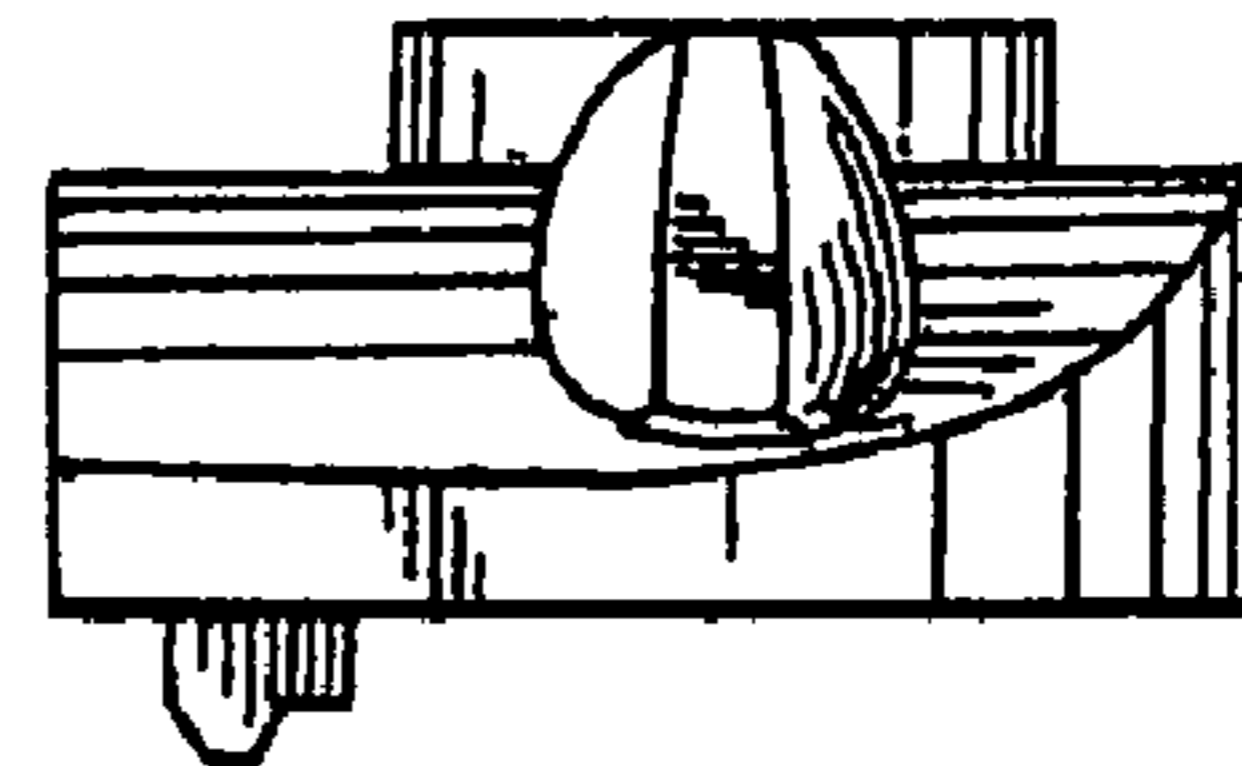

FIG. 7

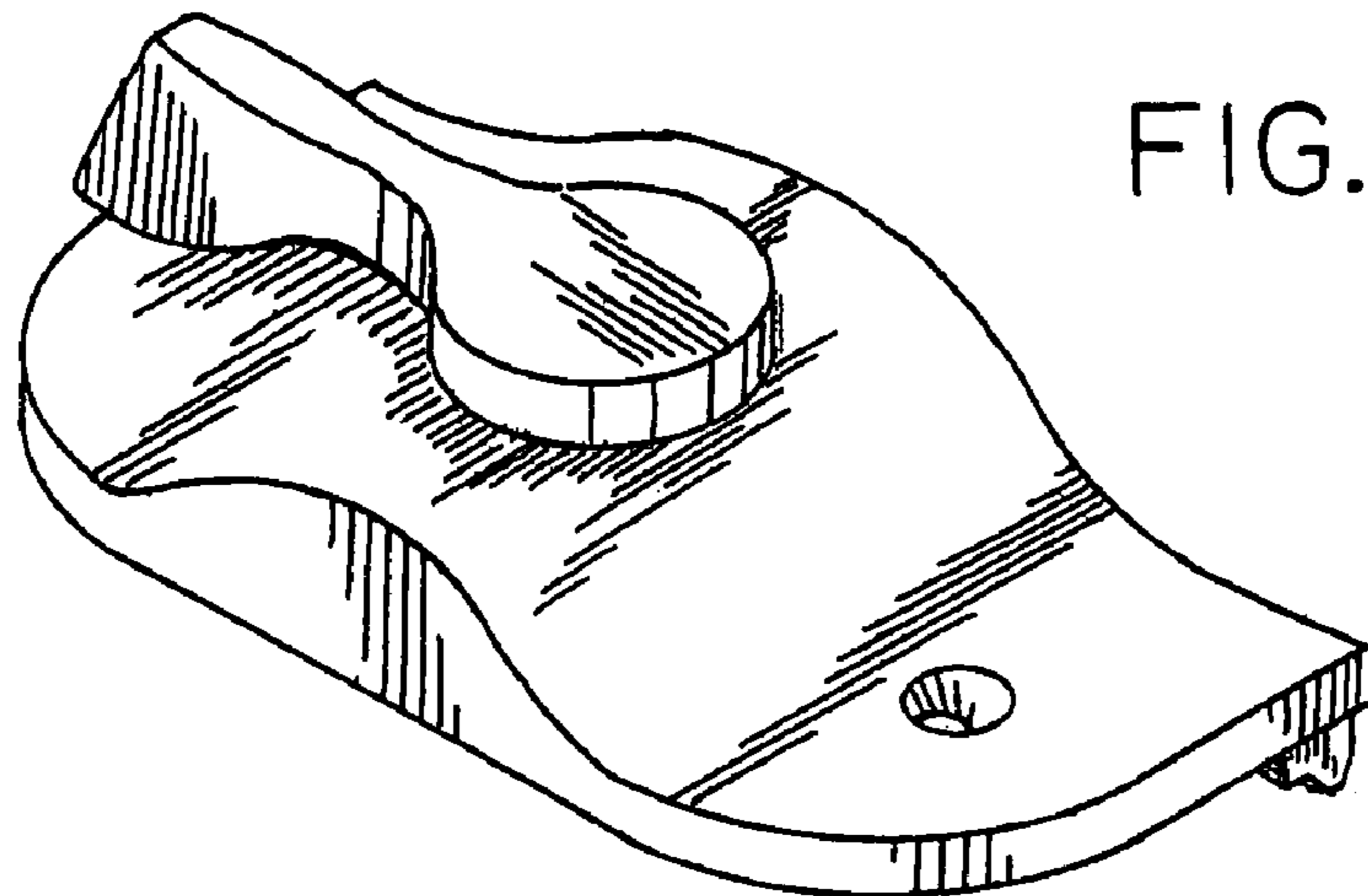
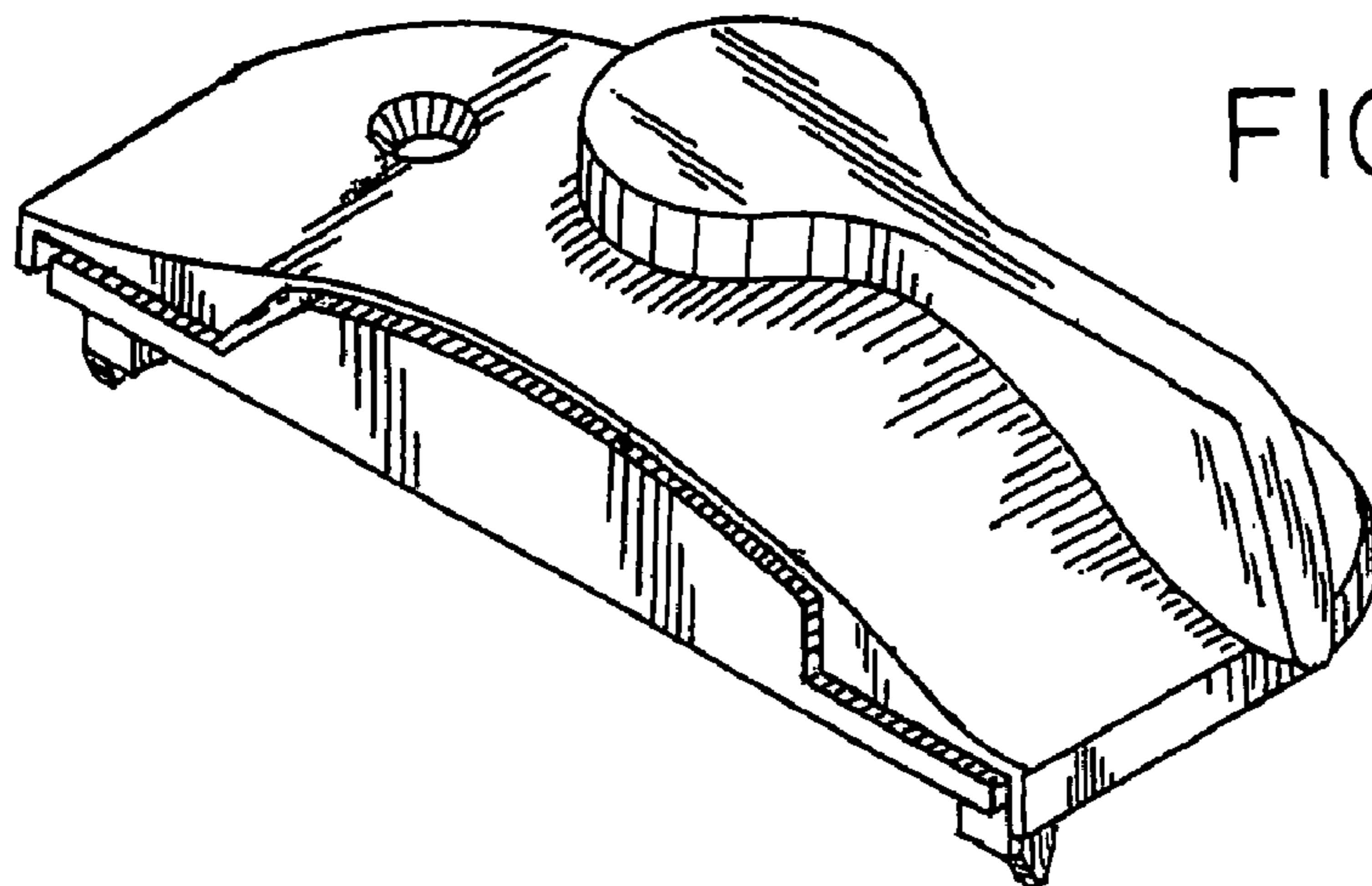

FIG. 8



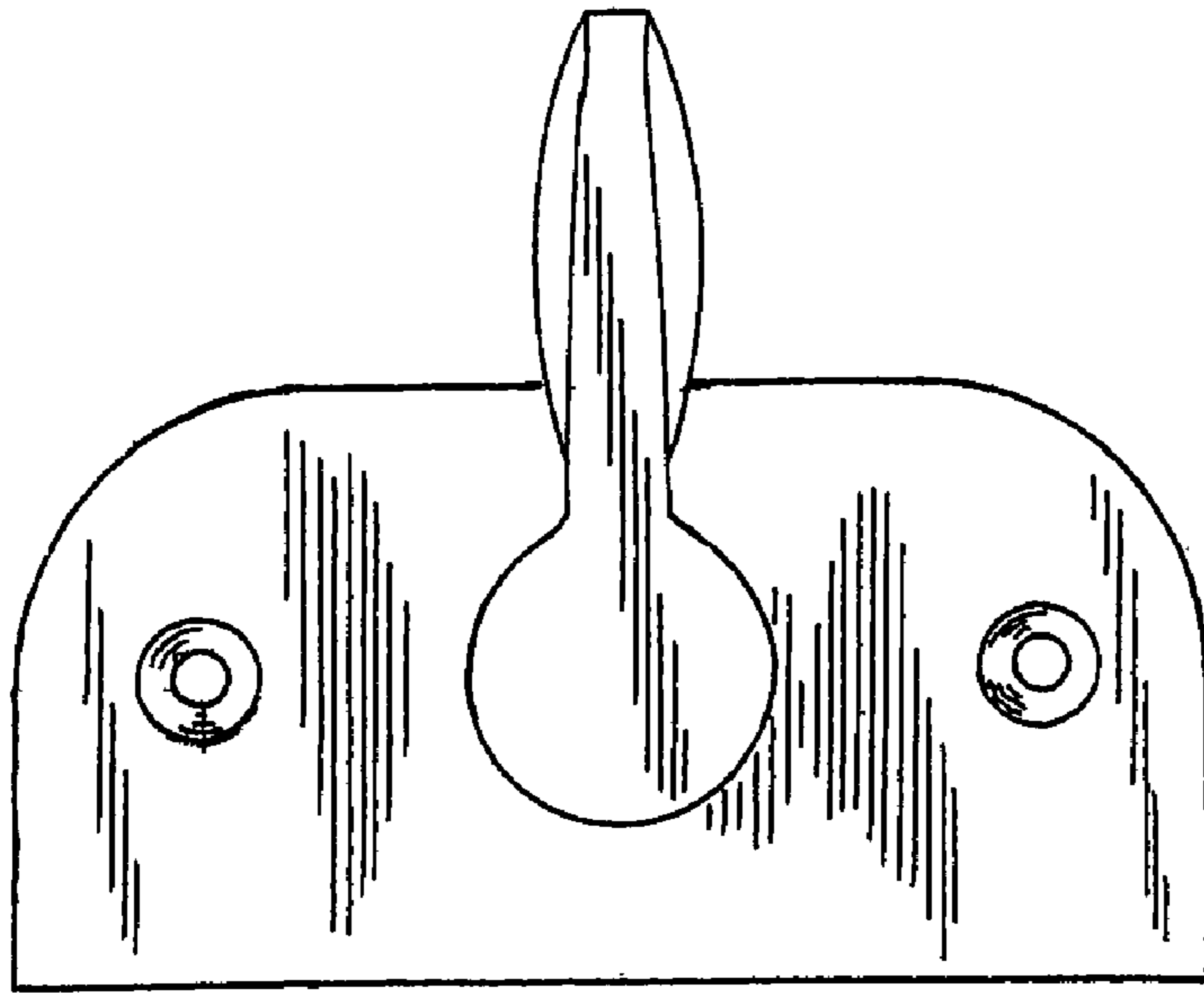

FIG. 9A



FIG. 9B

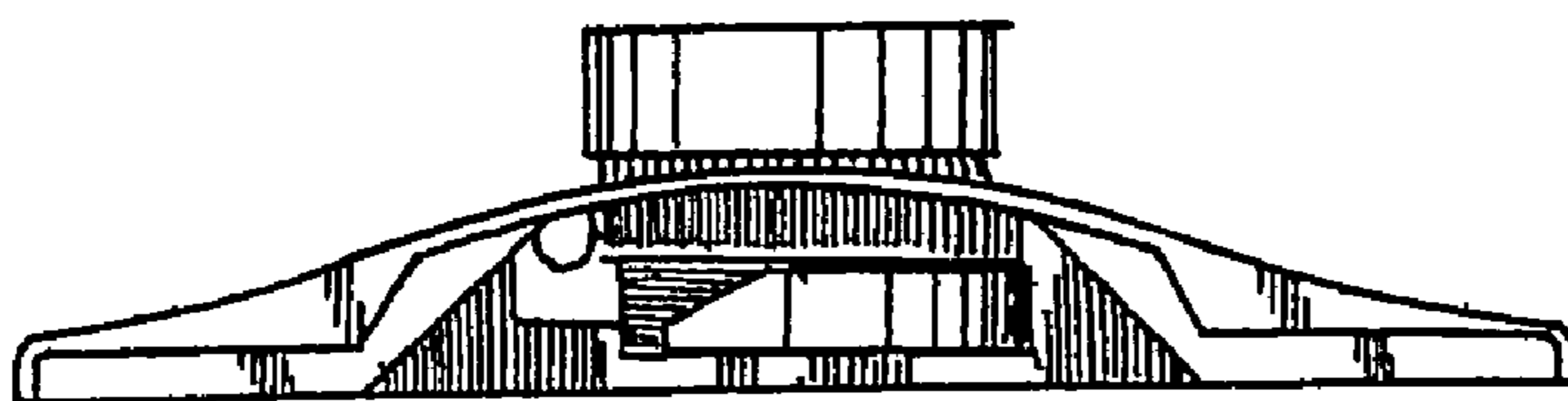

FIG. 10A

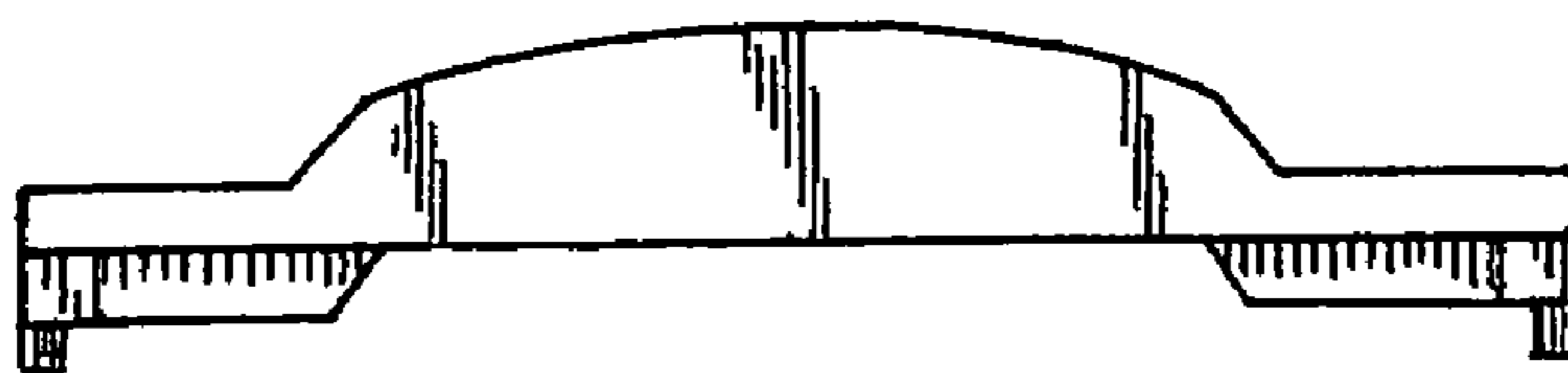

FIG. 10B

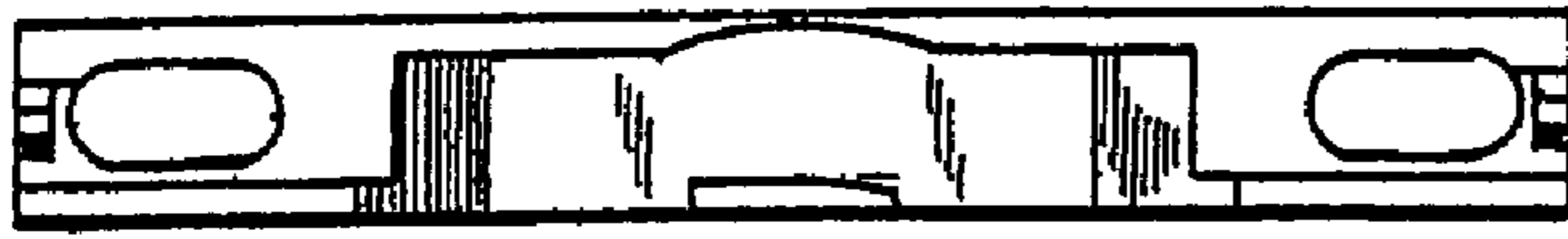

FIG. 11B

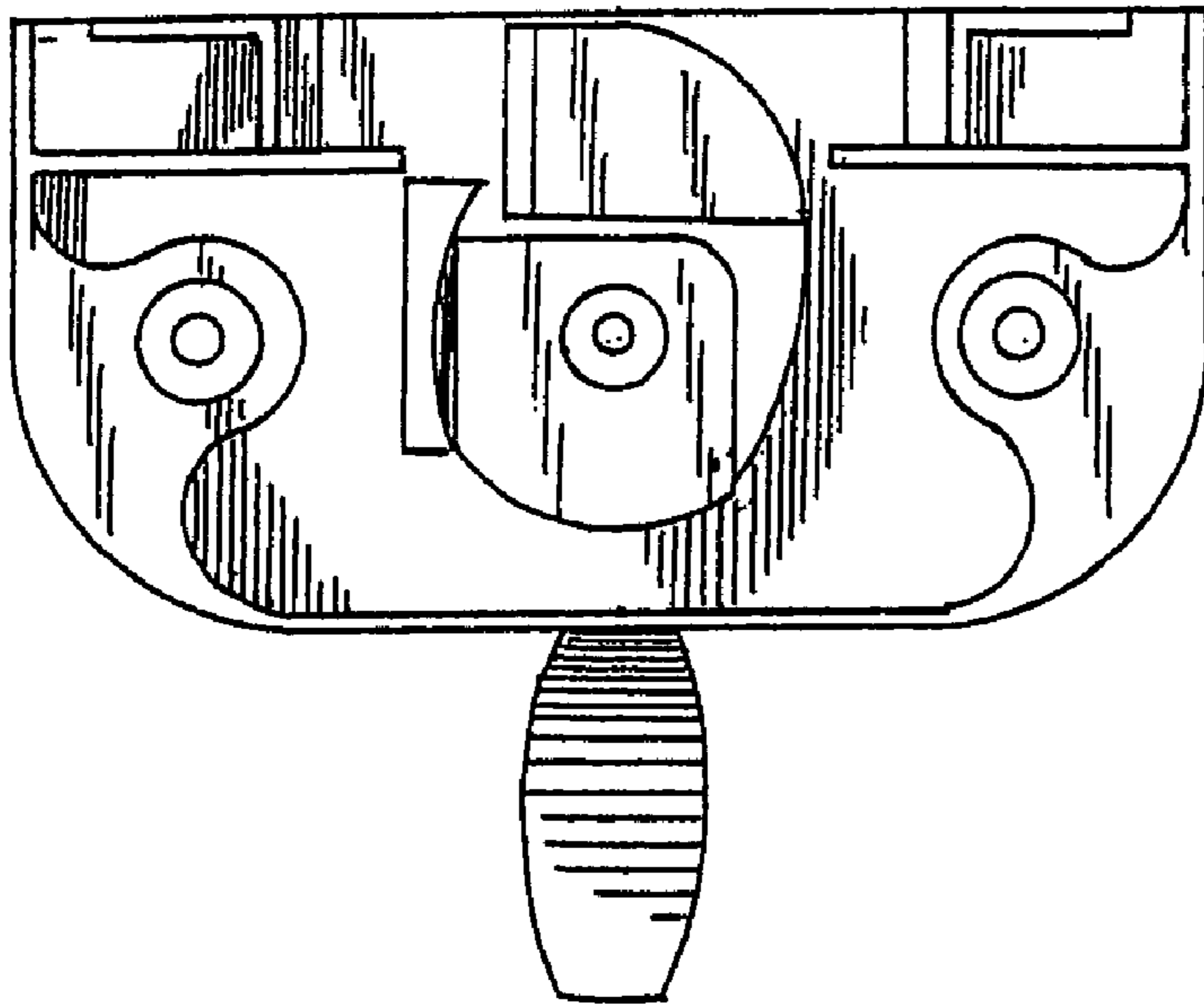

FIG. 11A

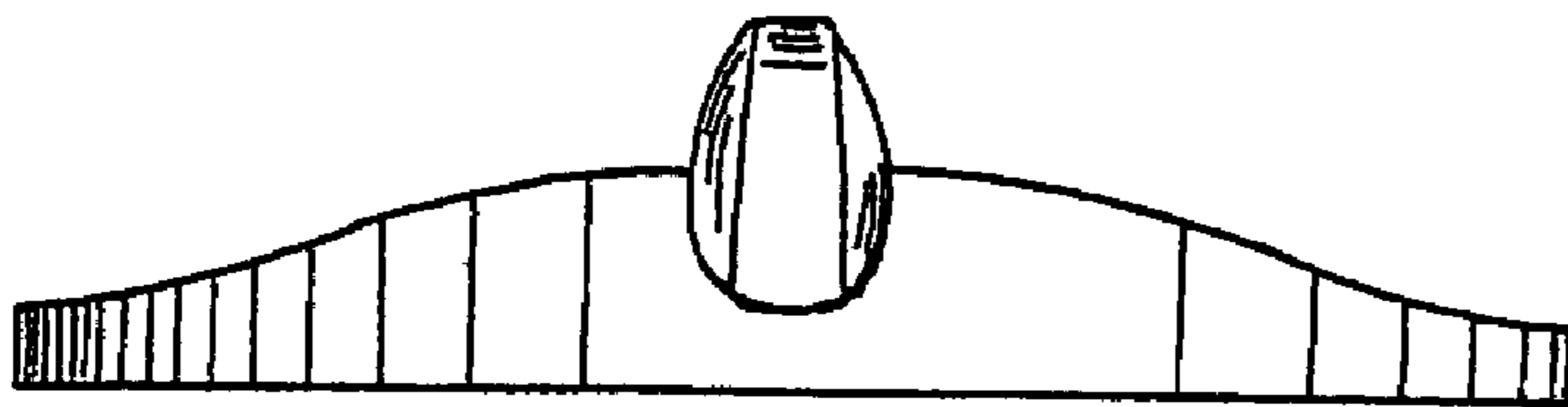

FIG. 12A

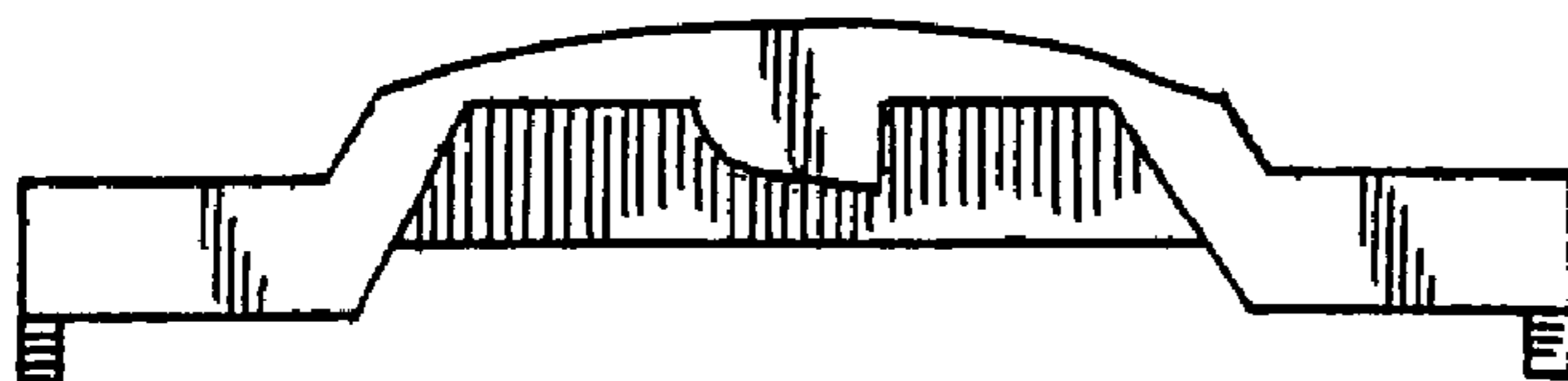

FIG. 12B



FIG. 13A

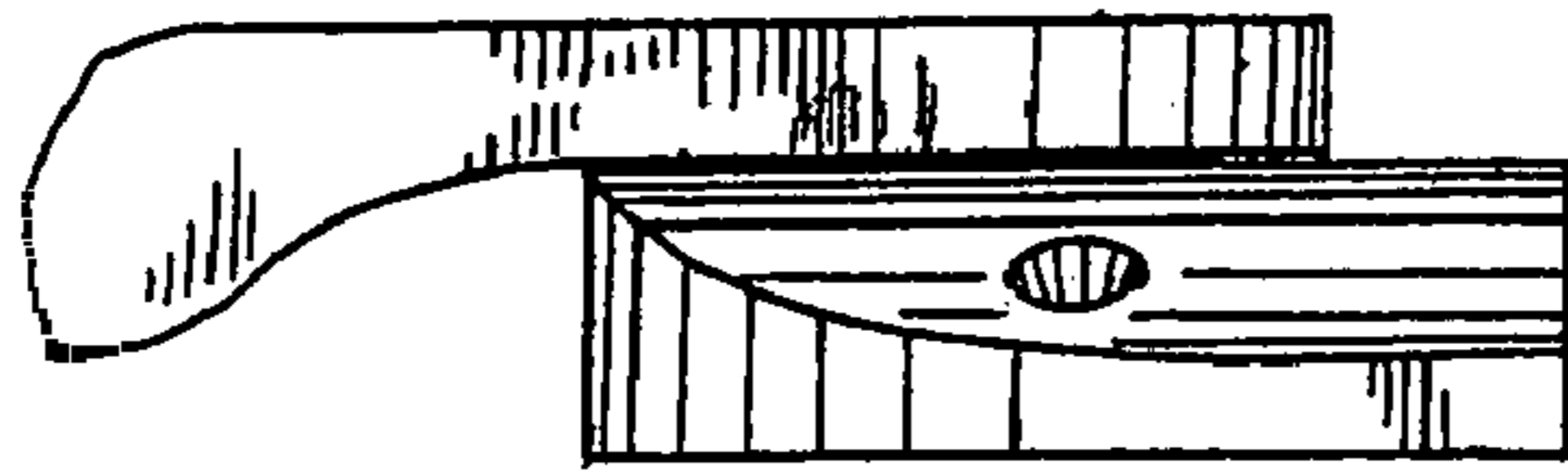

FIG. 13B



FIG. 14B



FIG. 14A

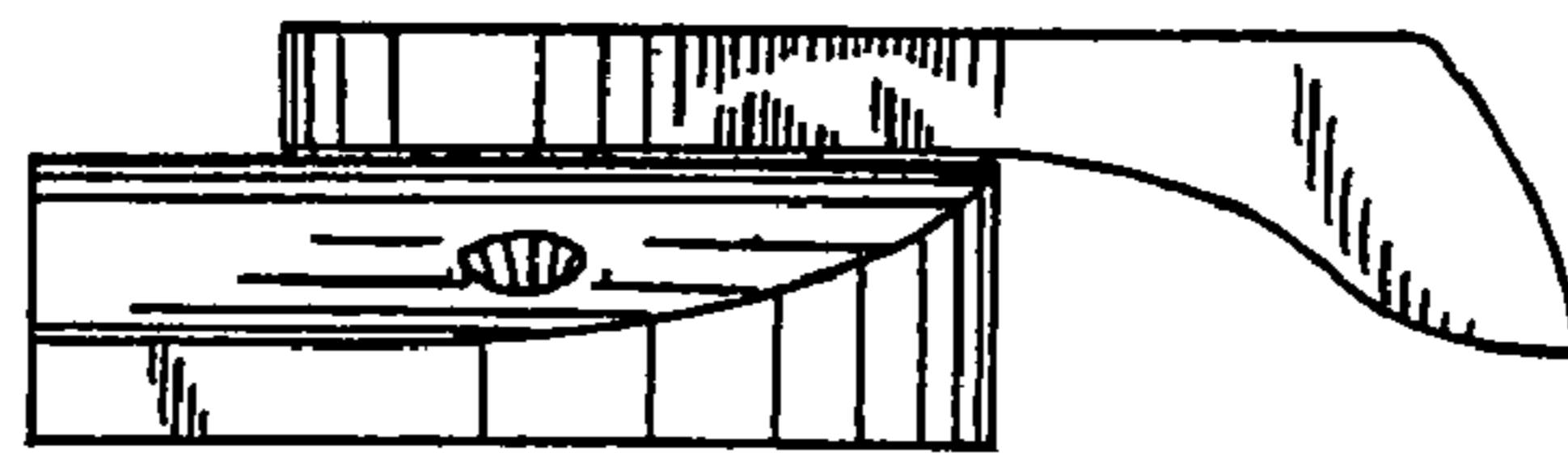

FIG. 15A

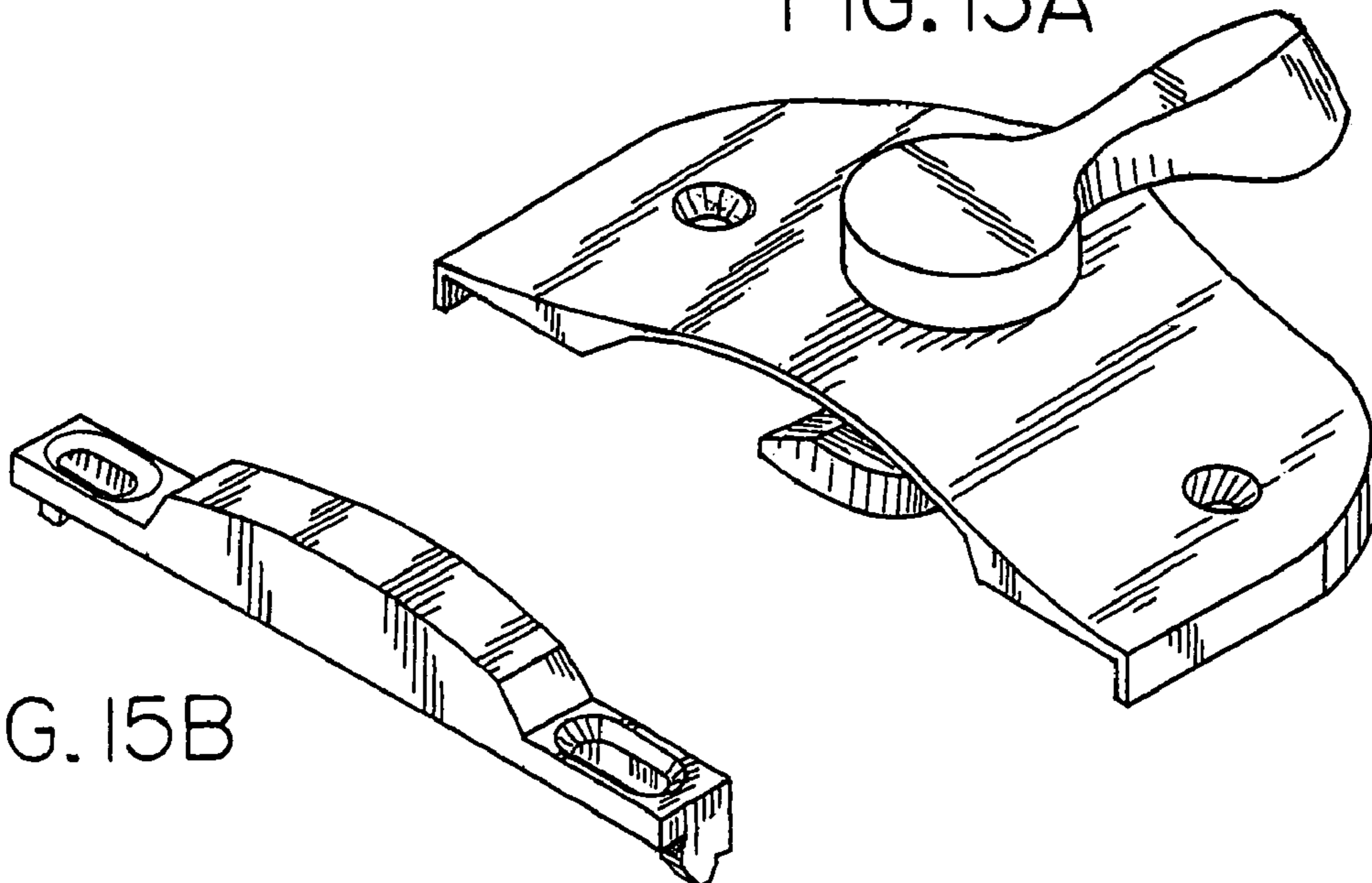

FIG. 15B