



US00D562006S

(12) **United States Design Patent**
Liu

(10) **Patent No.:** **US D562,006 S**
(45) **Date of Patent:** **** Feb. 19, 2008**

(54) **SNOW BRUSH**

(76) Inventor: **David Liu**, No. 24, Lane 180, Sec. 3,
Kangning Road, Neihu District, Taipei
(TW)

(**) Term: **14 Years**

(21) Appl. No.: **29/282,337**

(22) Filed: **Jul. 17, 2007**

(51) **LOC (8) Cl.** **04-01**

(52) **U.S. Cl.** **D4/130**

(58) **Field of Classification Search** D4/130,
D4/132, 135, 138, 199; D32/40, 50-52;
15/146, 159.1, 160, 191.1, 192, 193
See application file for complete search history.

(56) **References Cited**

U.S. PATENT DOCUMENTS

- D283,851 S * 5/1986 Walko D4/130
- D404,575 S * 1/1999 Vetter D4/130
- D477,149 S * 7/2003 Hay D4/130

OTHER PUBLICATIONS

General Purpose Brush from Product Page, Golden Star Plastics Co. Ltd. [online], Jan. 2005, [retrieved Sep. 26, 2007] Retrieved from the Internet: <URL: http://web.archive.org/web/*/http://www.goldenstarplastics.com>.*

WIPO DM/060455 Industrial Design Application (Billat Alain Edouard), Aug. 31, 2002, [online], [retrieved Sep. 25, 2007]

Retrieved from the Hague Express Database of the WIPO Intellectual Property Digital Library using the Internet: <URL: <http://www.wipo.int/ipdl>>.*

* cited by examiner

Primary Examiner—Cathron Brooks
Assistant Examiner—Lavone D. Tabor
(74) *Attorney, Agent, or Firm*—Banger Shia

(57) **CLAIM**

The ornamental design for a snow brush, as shown and described.

DESCRIPTION

FIG. 1 is a perspective view of a snow brush showing my present design,

FIG. 2 is a front view thereof;

FIG. 3 is a rear view thereof;

FIG. 4 is a left view thereof;

FIG. 5 is a right view thereof;

FIG. 6 is a top view thereof; and,

FIG. 7 is a bottom view.

The tips of the individual strands that make up the bristle tufts are omitted within the bounds of each of the round tufts in FIG. 3 for ease of illustration.

1 Claim, 4 Drawing Sheets

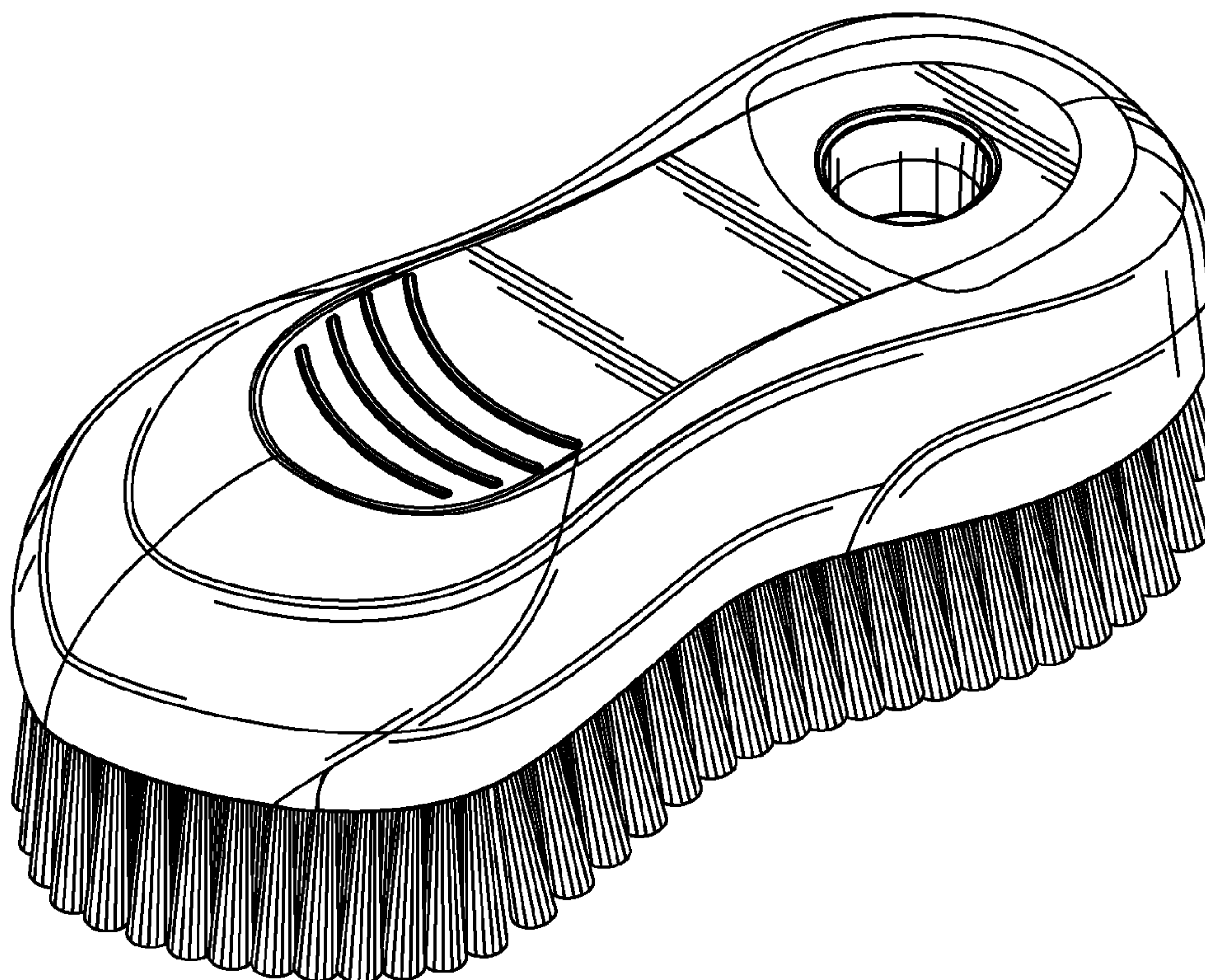

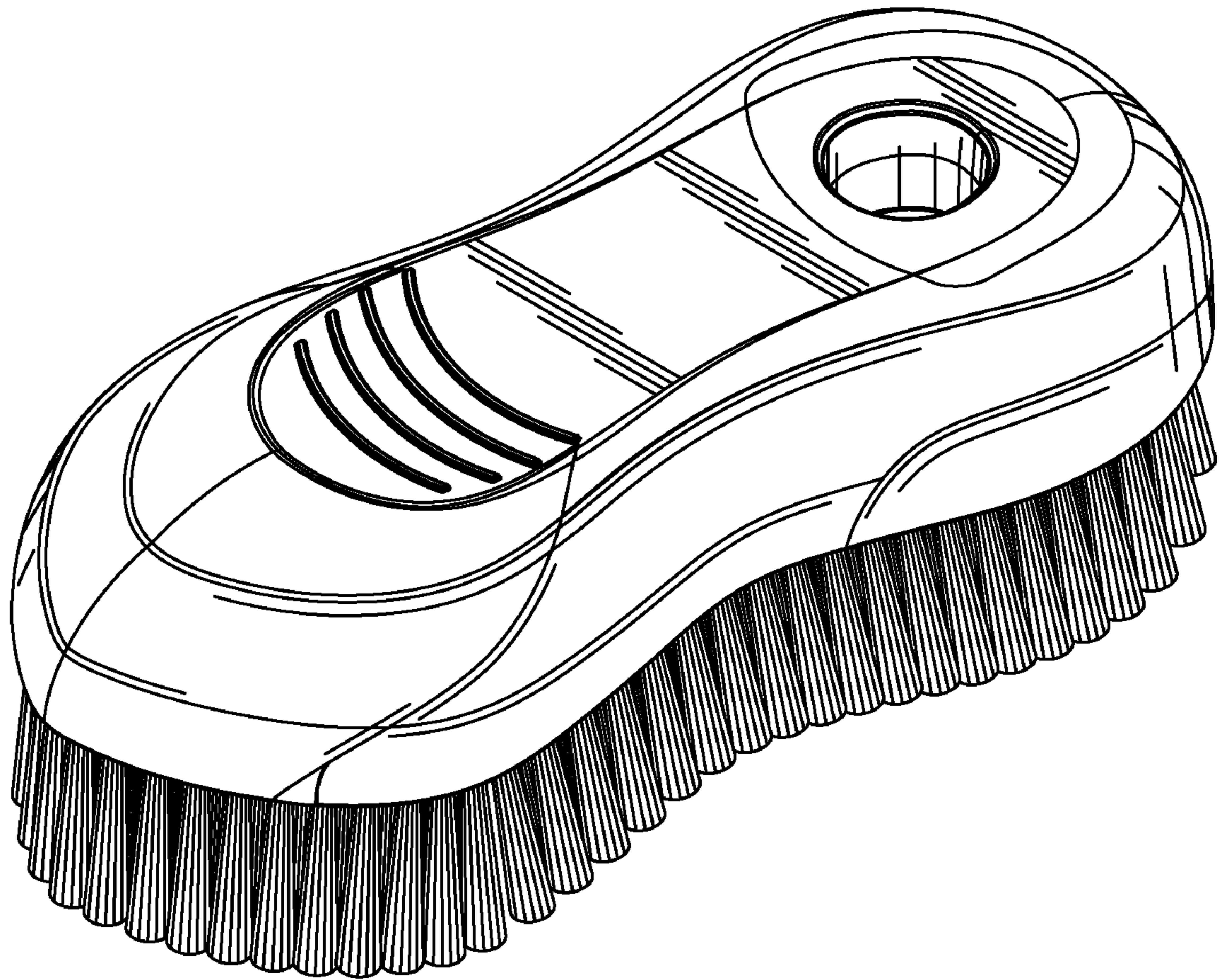

FIG. 1

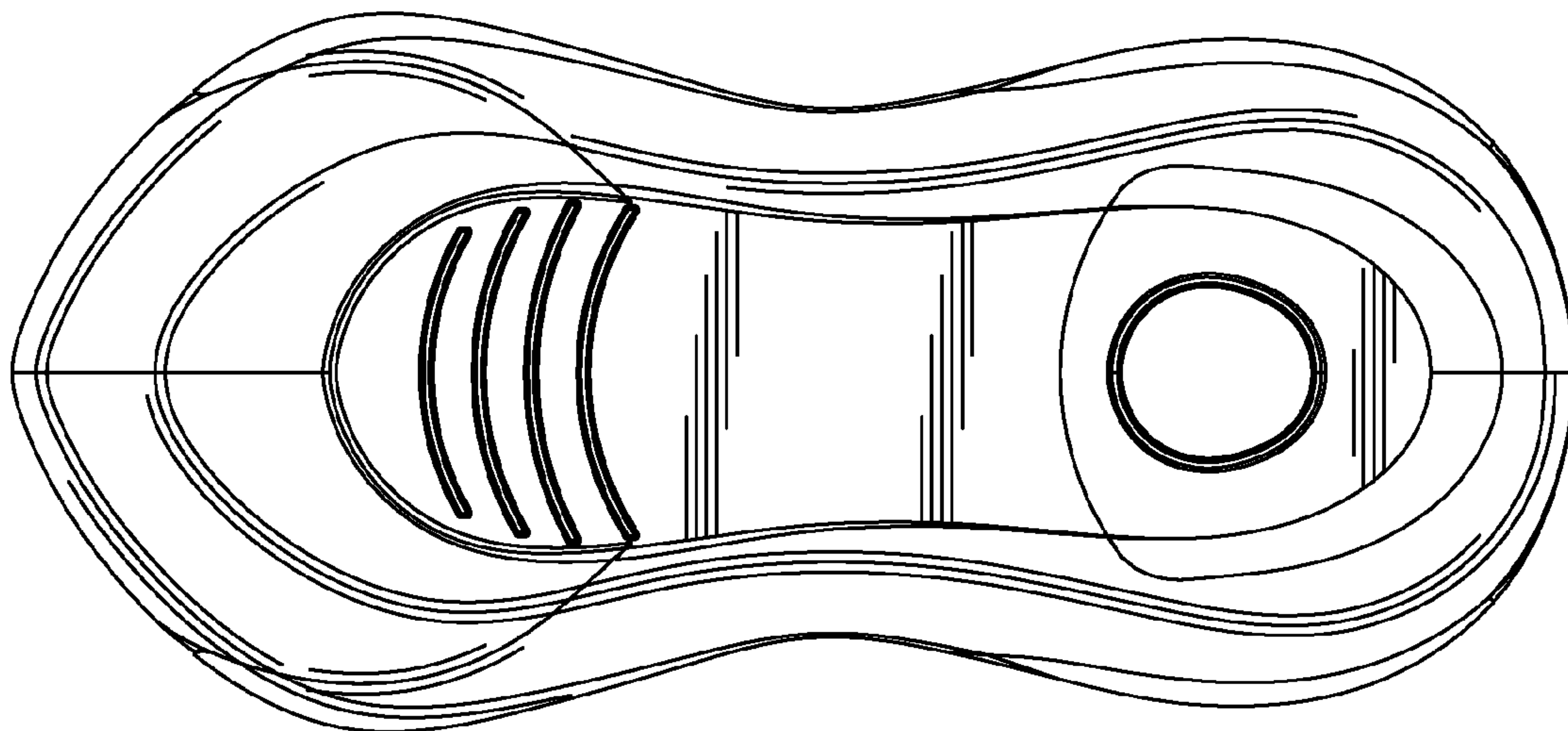

FIG. 2

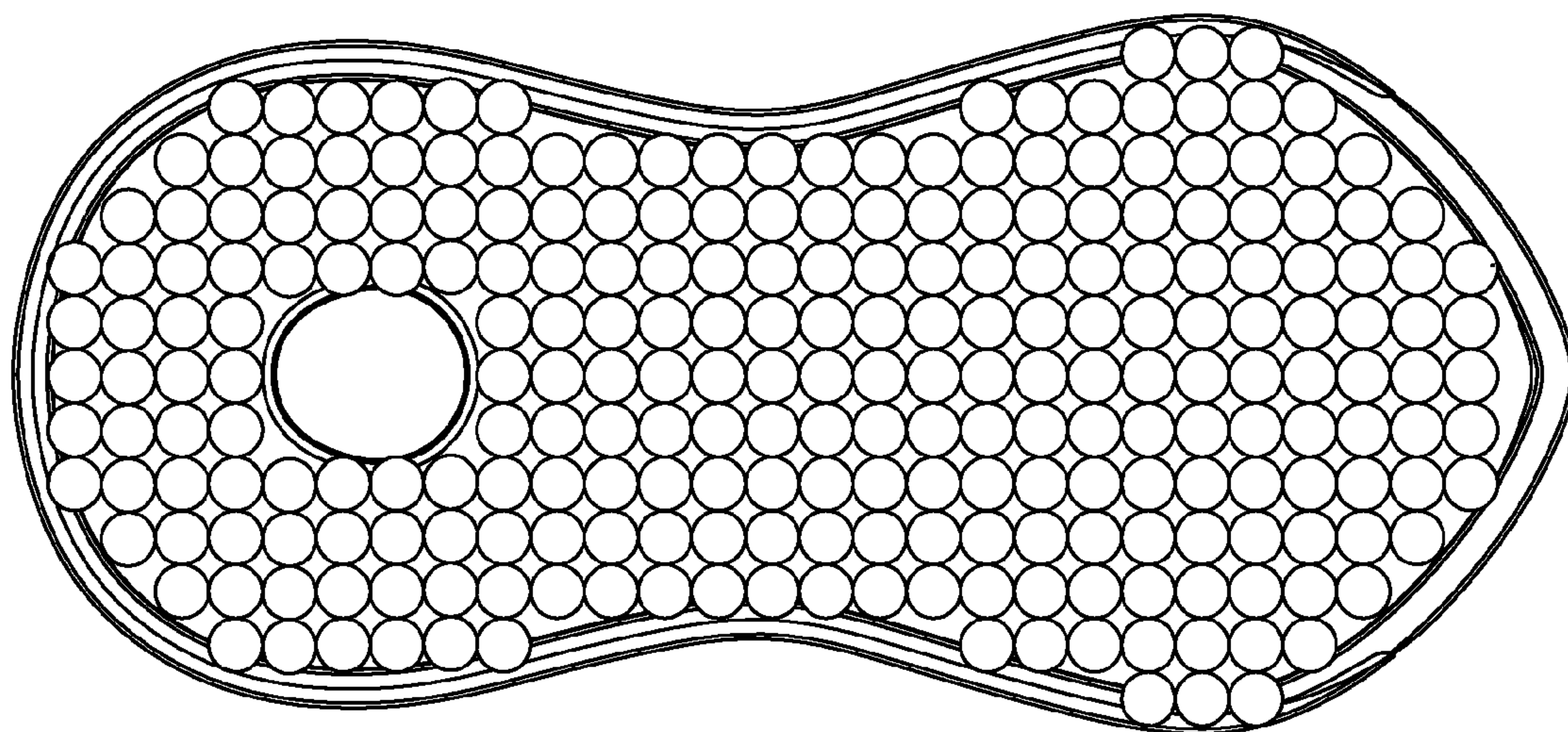

FIG. 3

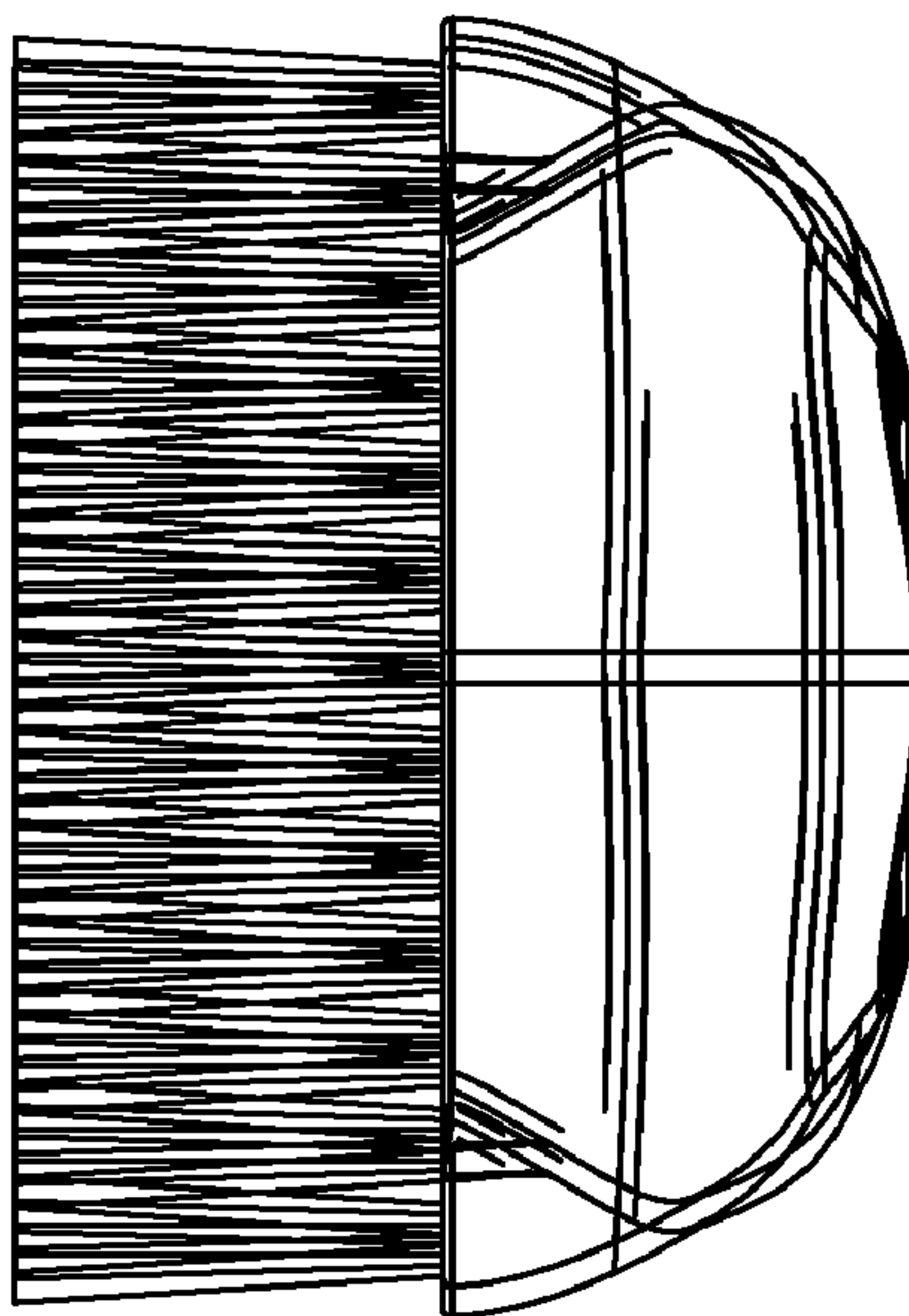

FIG. 4

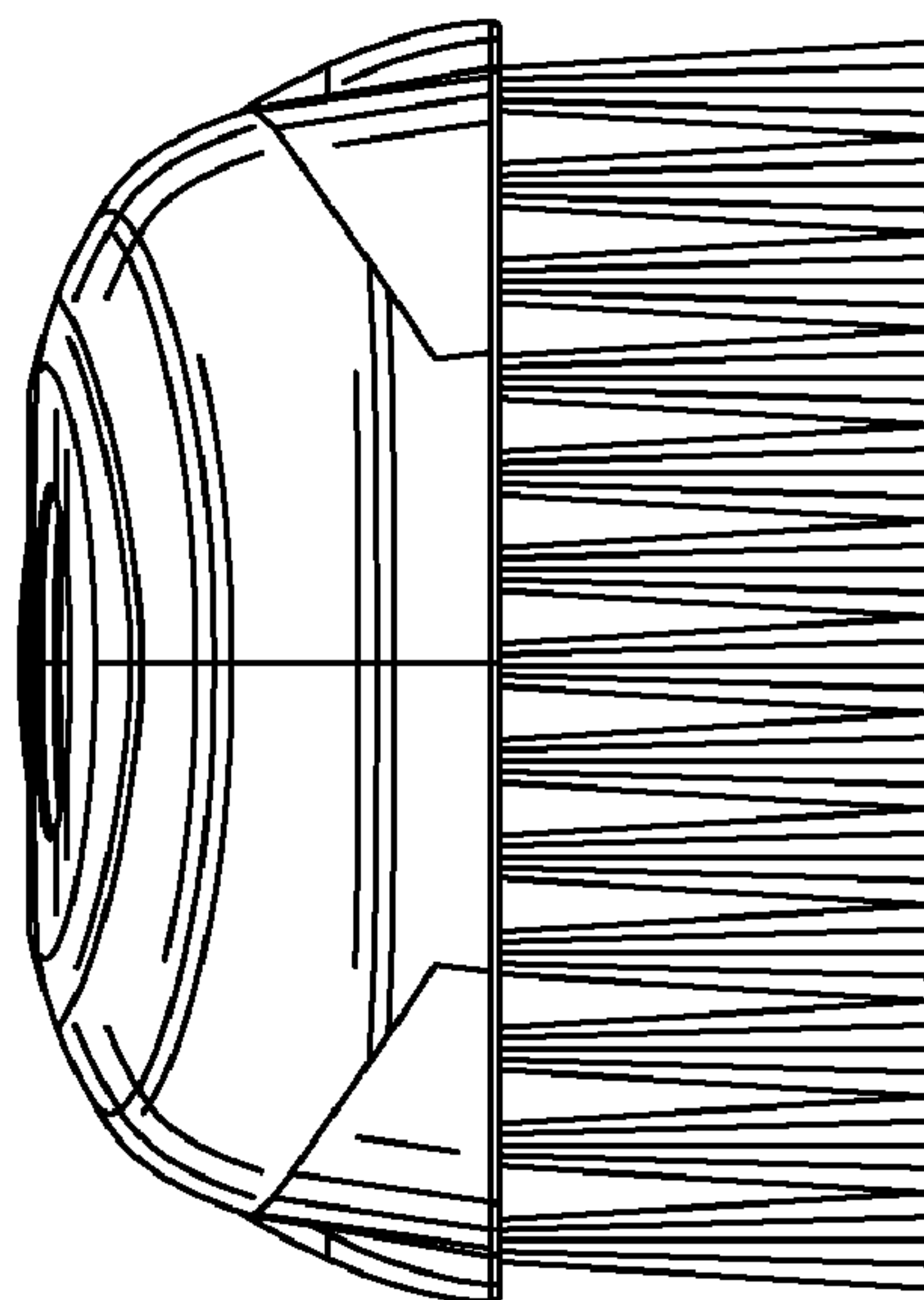

FIG. 5

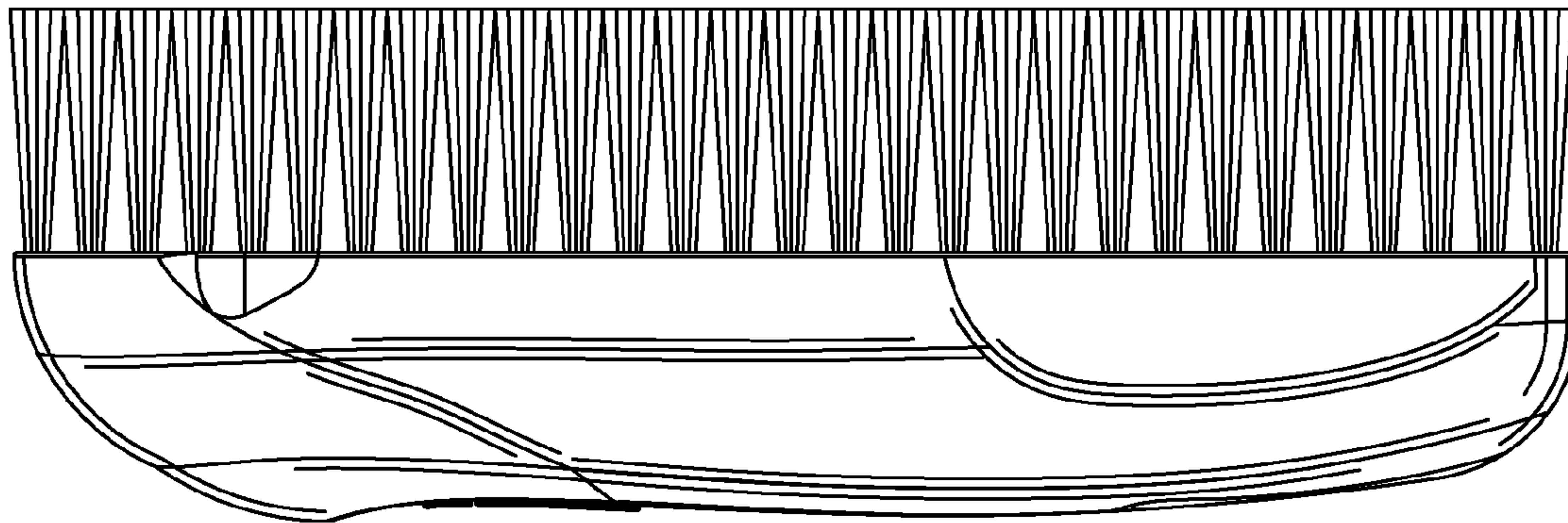

FIG. 6

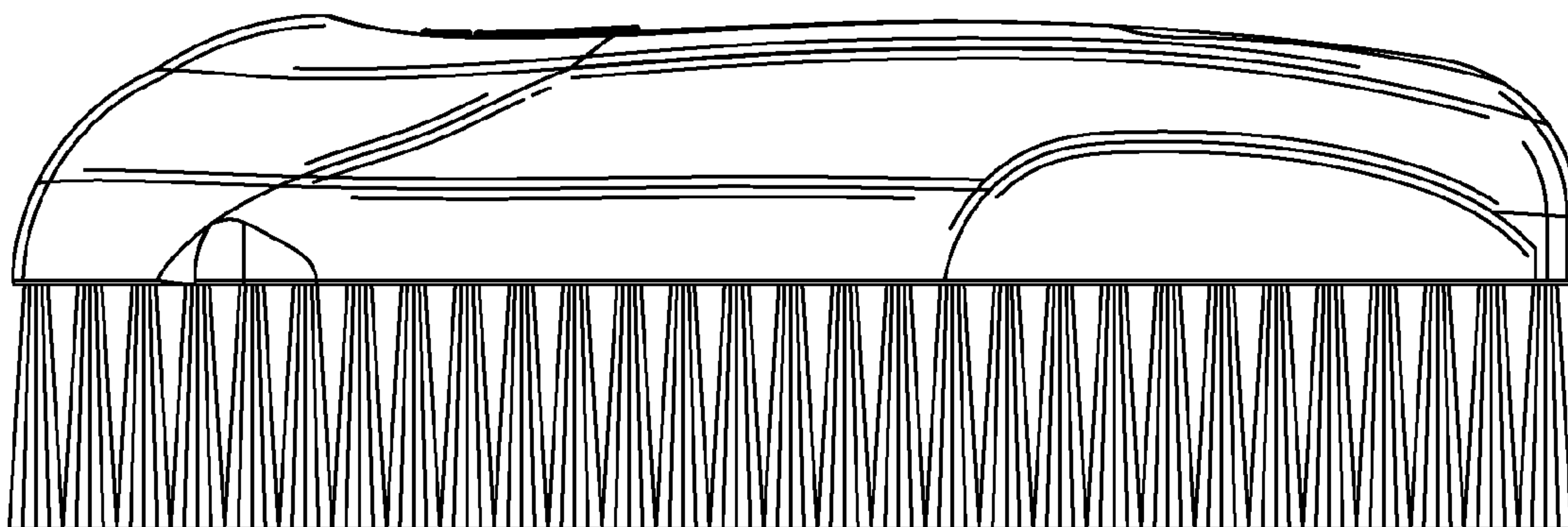

FIG. 7