



US00D561952S

(12) **United States Design Patent**
Lamstein et al.

(10) **Patent No.:** **US D561,952 S**
(45) **Date of Patent:** **** Feb. 12, 2008**

(54) **PET BED**

(76) Inventors: **Aaron Lamstein**, 160 Mitchell Rd.,
San Rafael, CA (US) 94903-2044;
David Haaf, 160 Mitchell Rd., San
Rafael, CA (US) 94903-2044

(**) Term: **14 Years**

(21) Appl. No.: **29/259,300**

(22) Filed: **May 5, 2006**

(51) **LOC (8) Cl.** **30-06**

(52) **U.S. Cl.** **D30/118; D6/595**

(58) **Field of Classification Search** D30/118,
D30/161, 199; D21/520, 521; D6/331, 334,
D6/382, 390, 393-394, 596-597, 601, 604,
D6/381; 119/28.5, 161, 165, 706
See application file for complete search history.

(56) **References Cited**

U.S. PATENT DOCUMENTS

D284,248 S *	6/1986	Challen	D6/601
5,144,911 A *	9/1992	Moore et al.	119/28.5
D381,234 S *	7/1997	Lupoff	D6/601
5,855,033 A *	1/1999	Frissen et al.	5/706
D454,236 S *	3/2002	Kaplan	D30/118
6,393,639 B1 *	5/2002	Ohsner	5/425
D463,701 S *	10/2002	Borcherding et al.	D6/601
D487,373 S *	3/2004	Ku	D6/604
2002/0108578 A1 *	8/2002	Kostial	119/28.5
2004/0134433 A1 *	7/2004	Holder	119/28.5
2006/0272582 A1 *	12/2006	Dunn et al.	119/28.5

* cited by examiner

Primary Examiner—Cathy Anne MacCormac
(74) *Attorney, Agent, or Firm*—Dergosits & Noah LLP

(57) **CLAIM**

The ornamental design for a pet bed, as shown and described.

DESCRIPTION

FIG. 1 is a perspective view of a pet bed showing our new design;

FIG. 2 is another perspective view thereof without the cat scratching insert, shown separately for ease of illustration;

FIG. 3 is a top plan view of FIG. 2;

FIG. 4 is a bottom plan view thereof;

FIG. 5 is a front view of FIG. 2;

FIG. 6 is a rear view of FIG. 2;

FIG. 7 is a right side view of FIG. 2;

FIG. 8 is a left side view of FIG. 2;

FIG. 9 is a perspective view of the cat scratching insert, shown separately for ease of illustration;

FIG. 10 is a top plan view of FIG. 9;

FIG. 11 is a bottom plan view of FIG. 9;

FIG. 12 is a front view of FIG. 9; and,

FIG. 13 is a left side view of FIG. 9.

The broken lines are for purposes of illustration only and form no part of the claimed design.

1 Claim, 5 Drawing Sheets

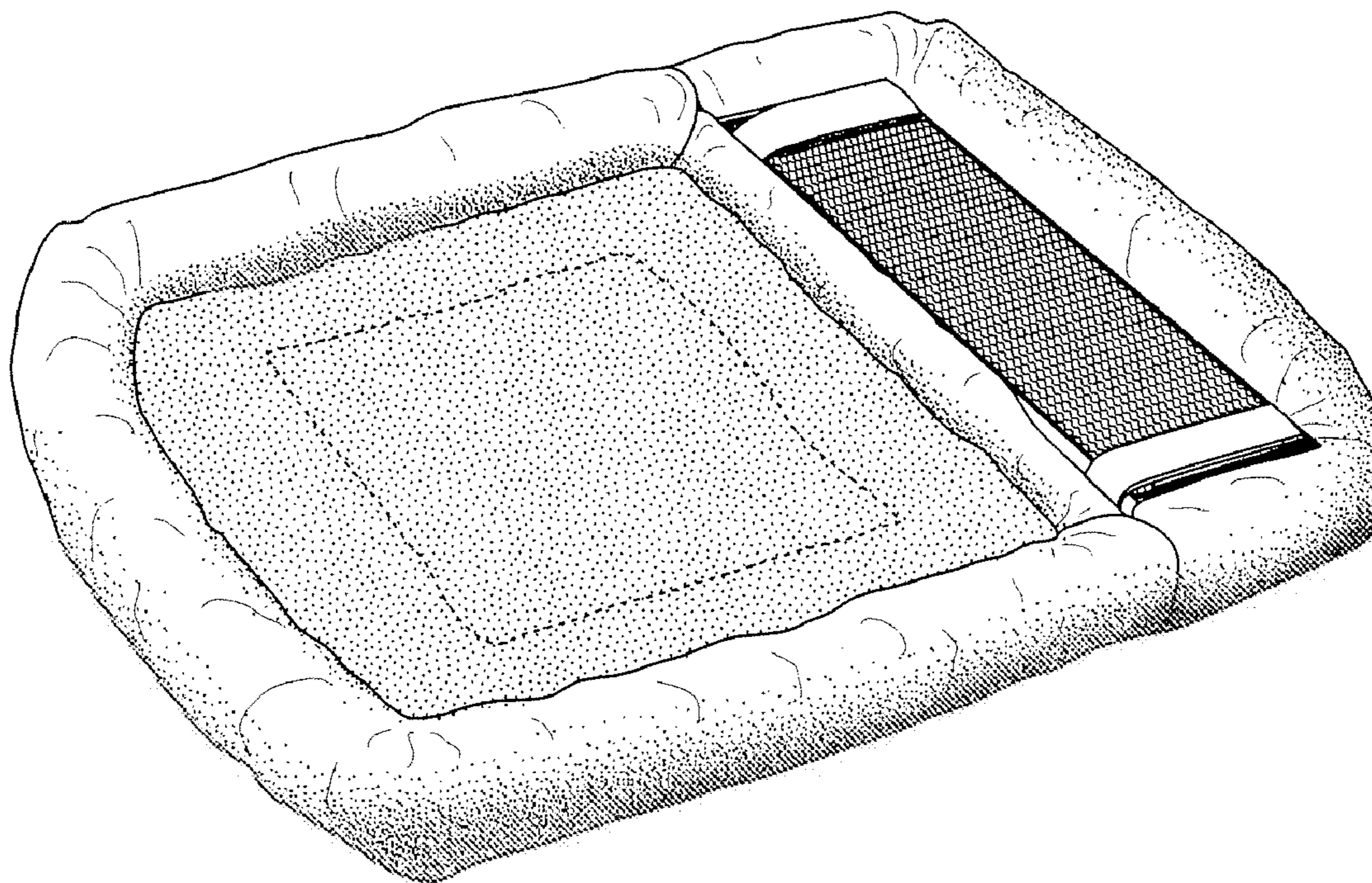

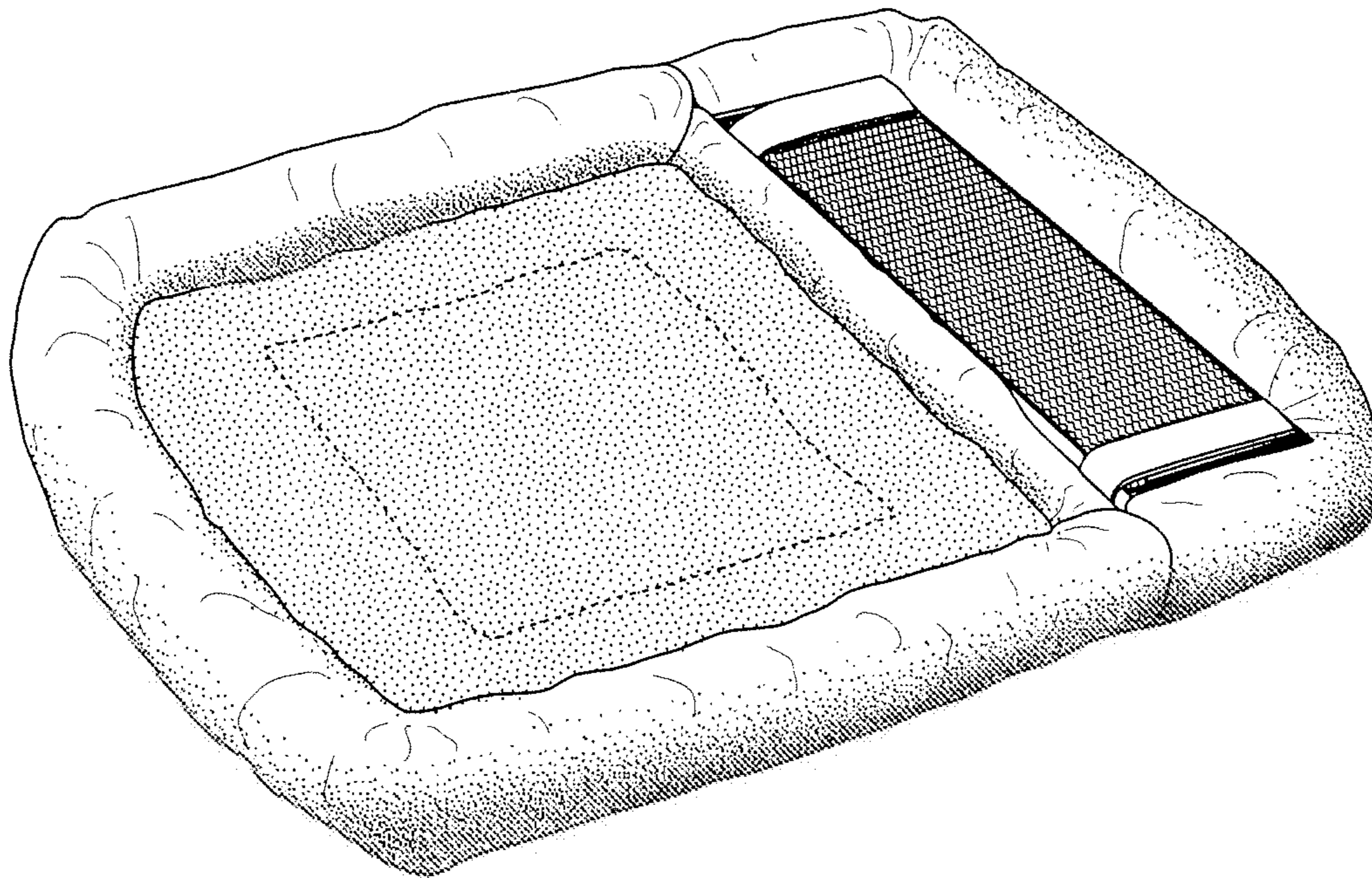

FIG. 1

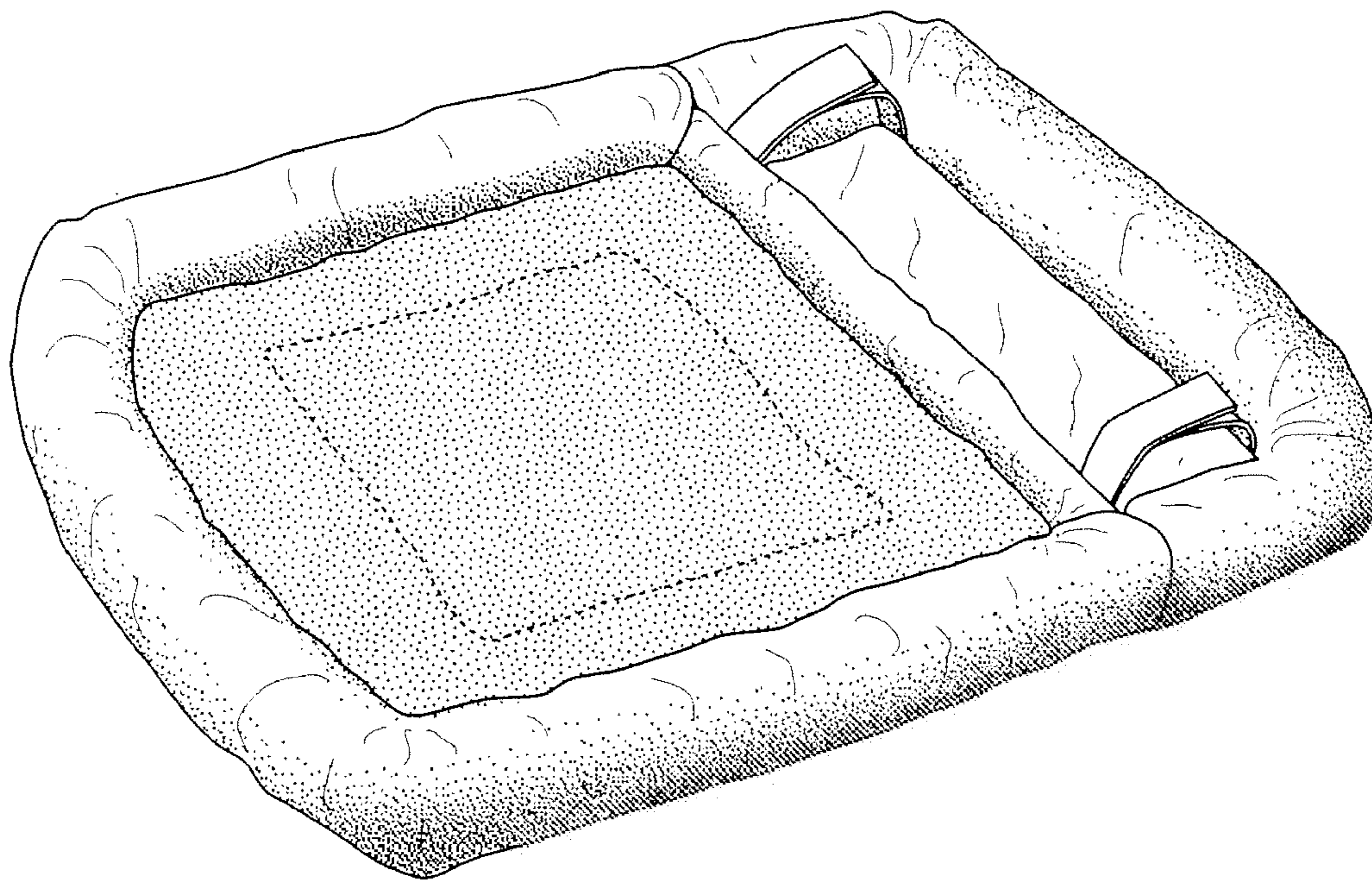

FIG. 2

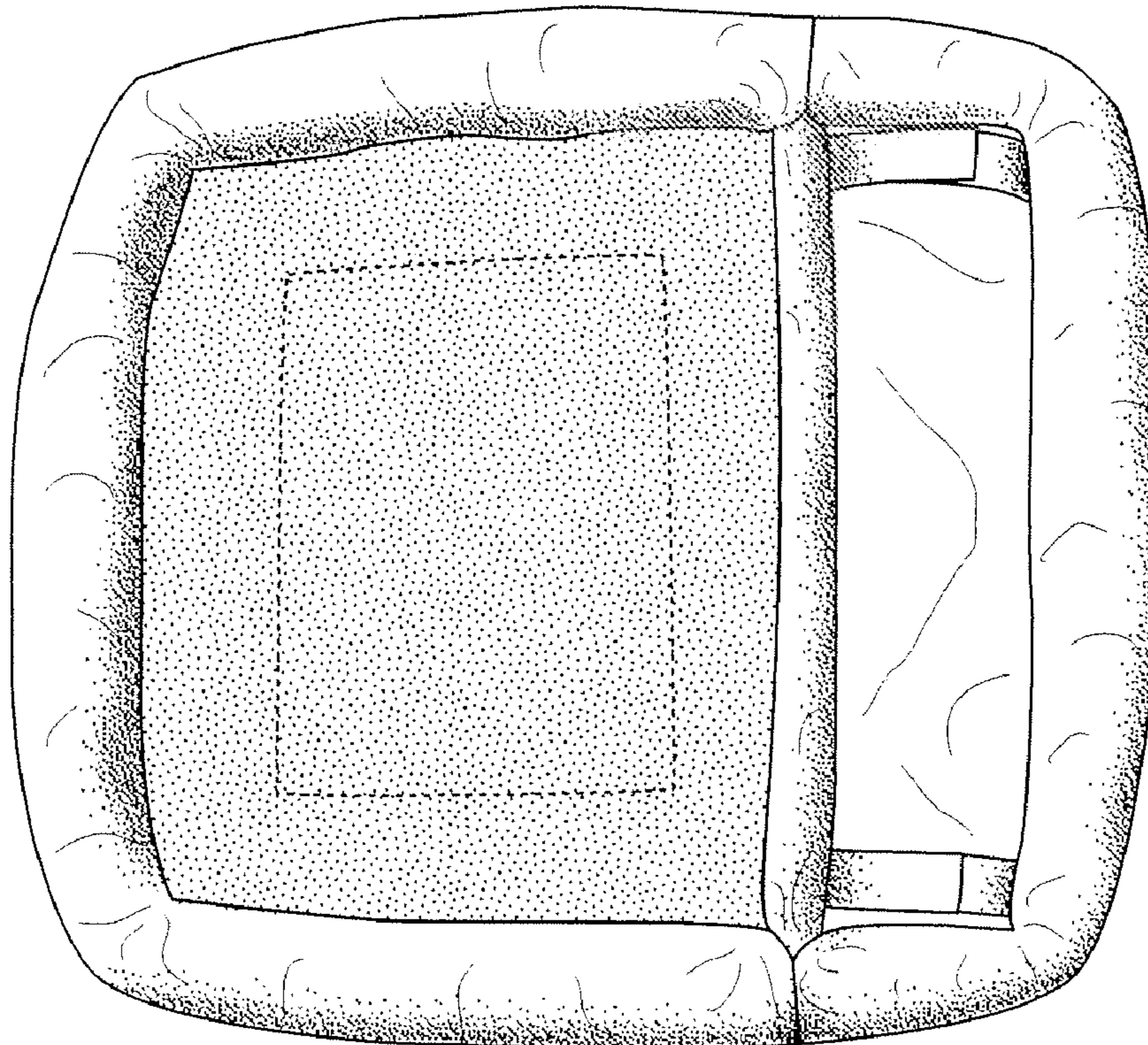

FIG. 3

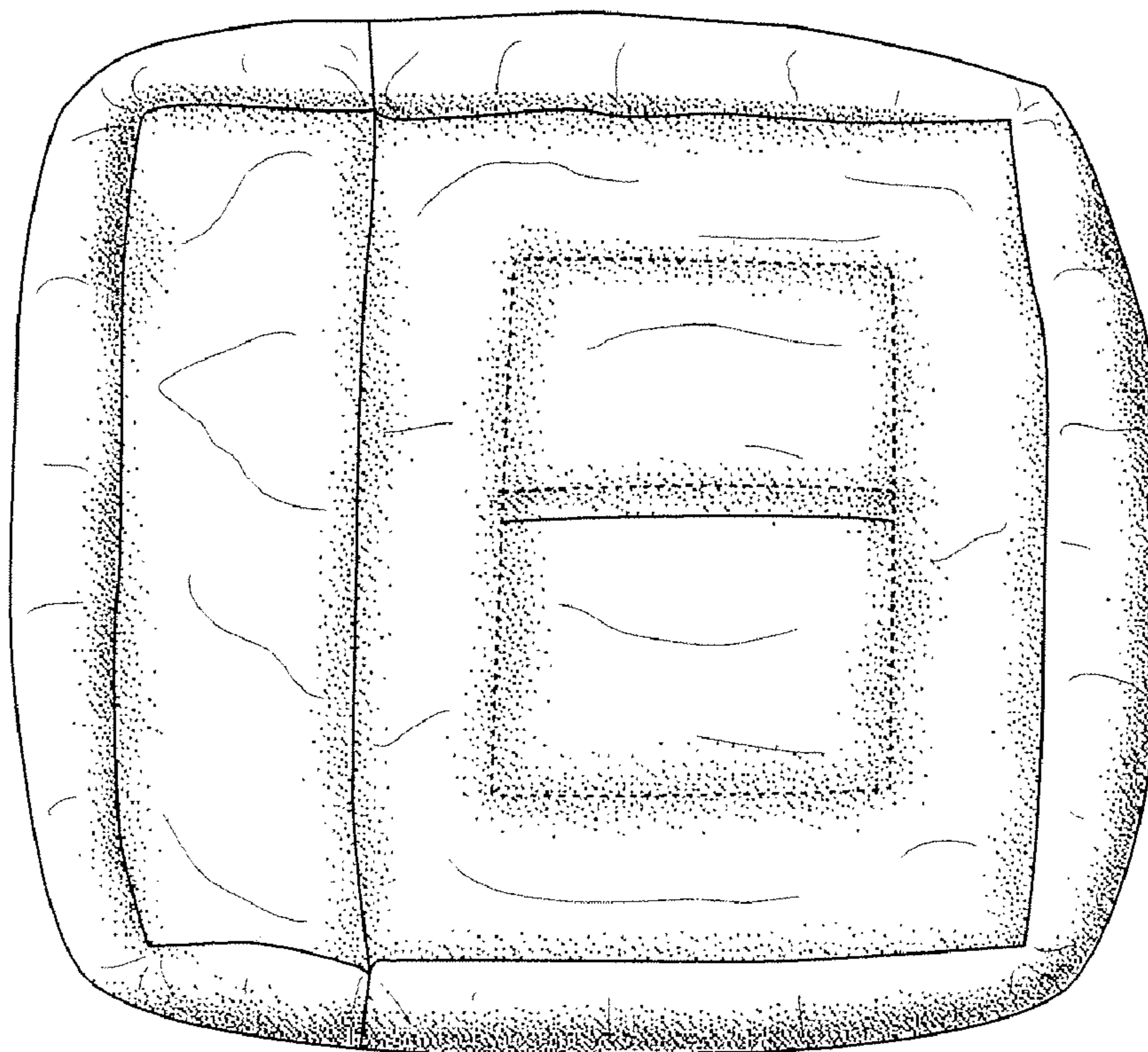

FIG. 4

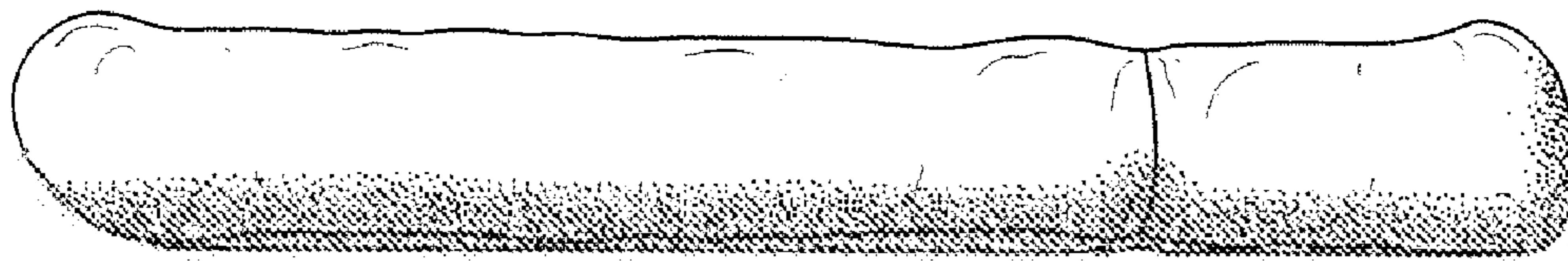

FIG. 5

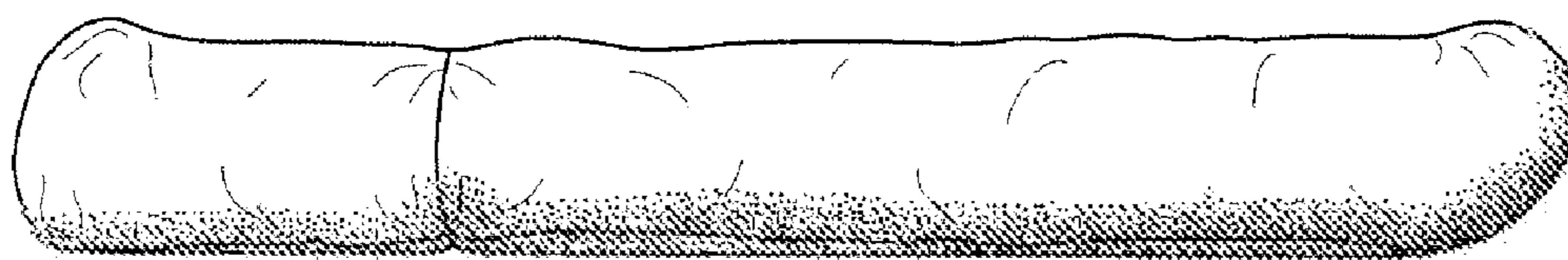

FIG. 6

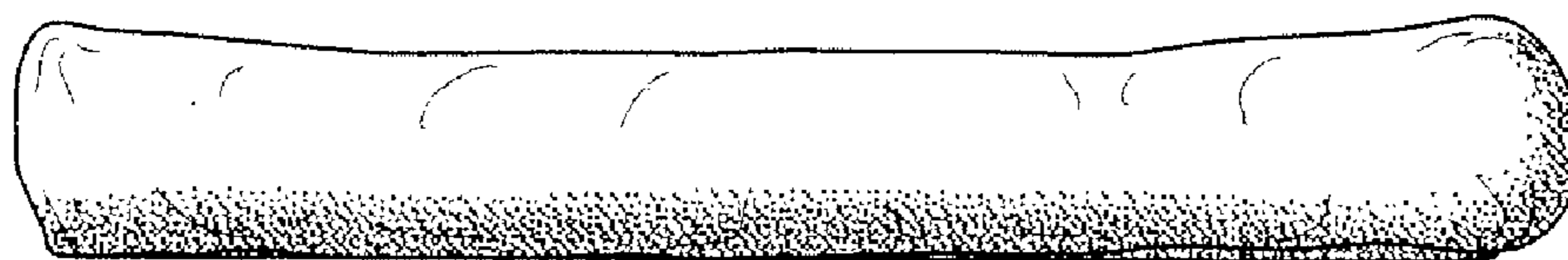

FIG. 7

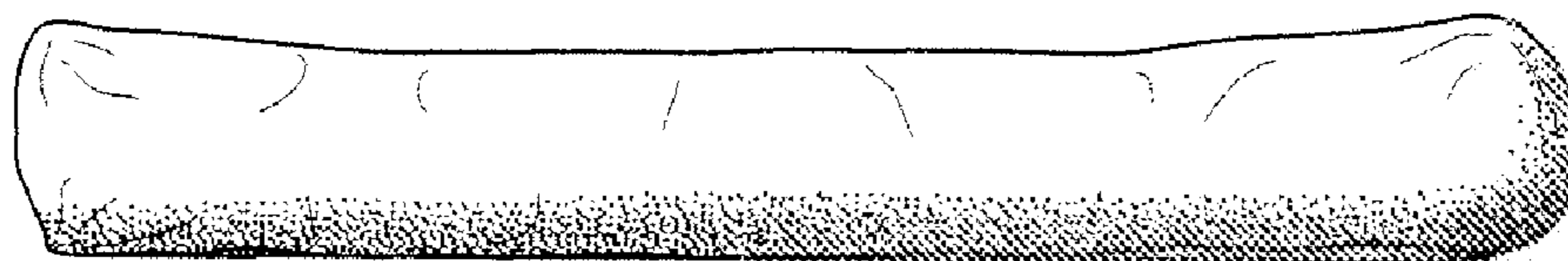

FIG. 8

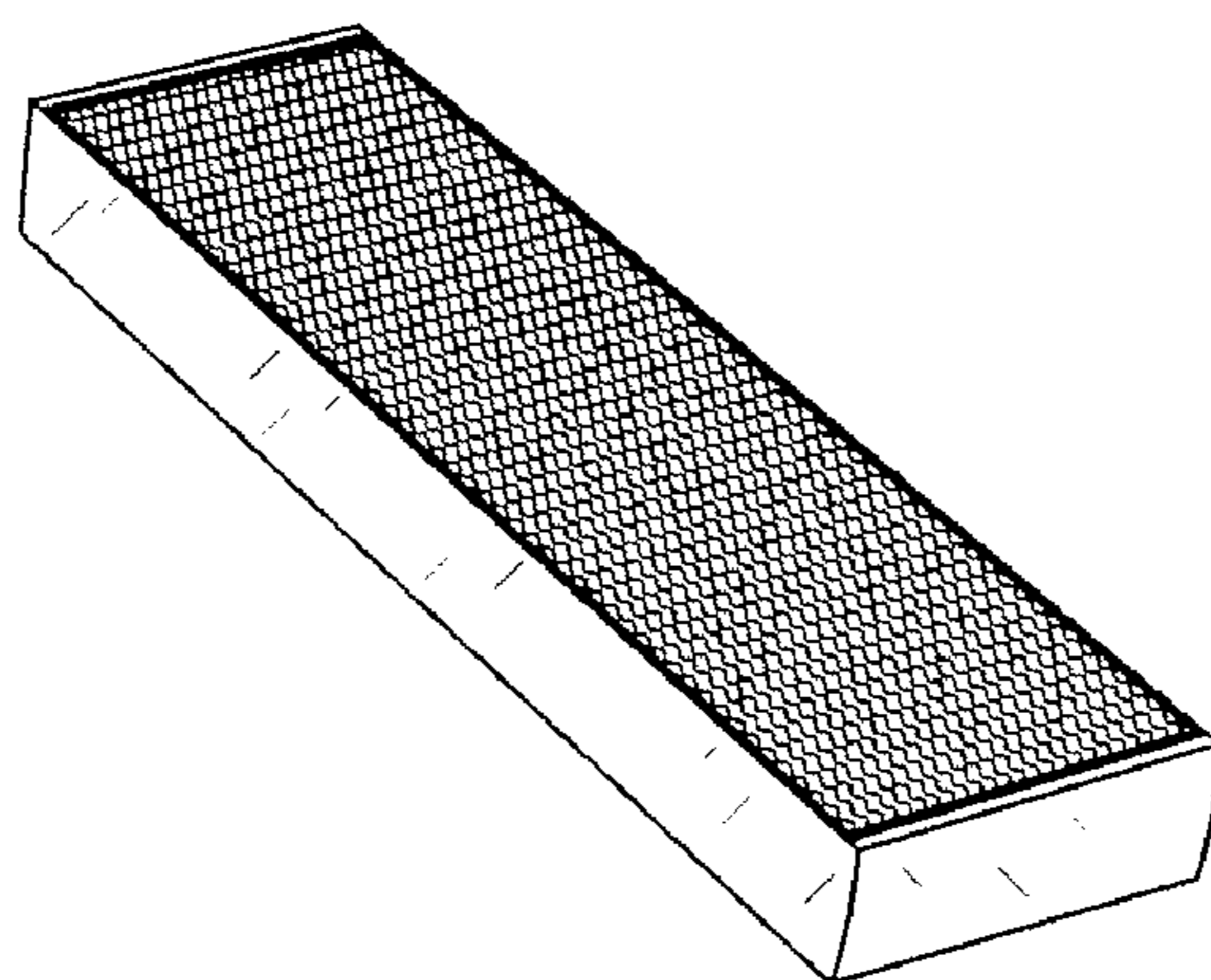

FIG. 9

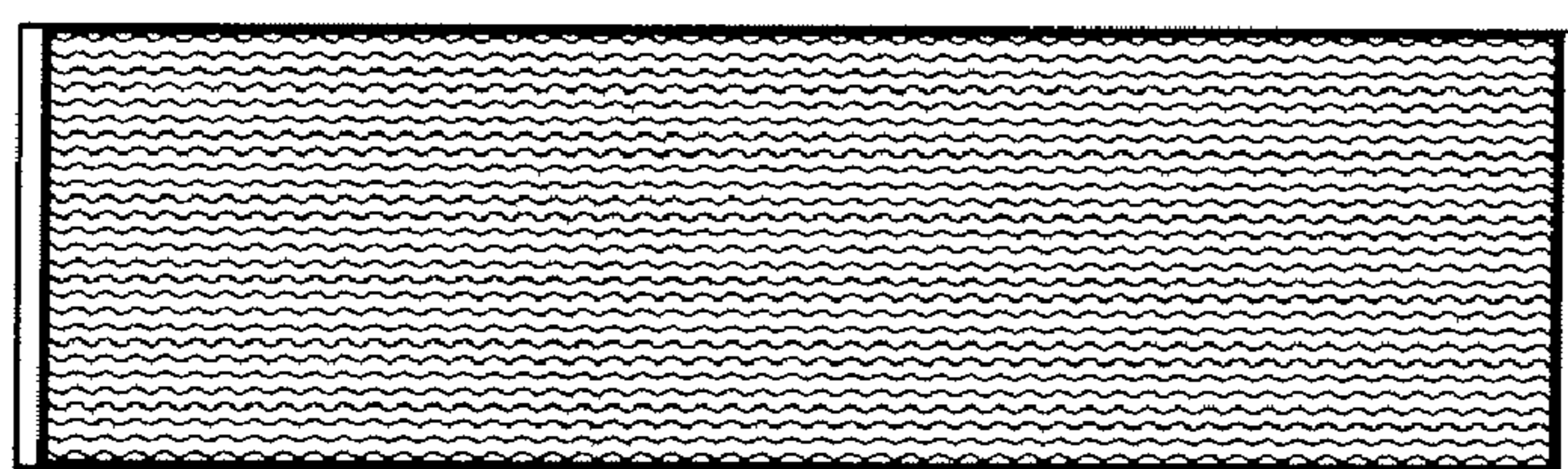

FIG. 10

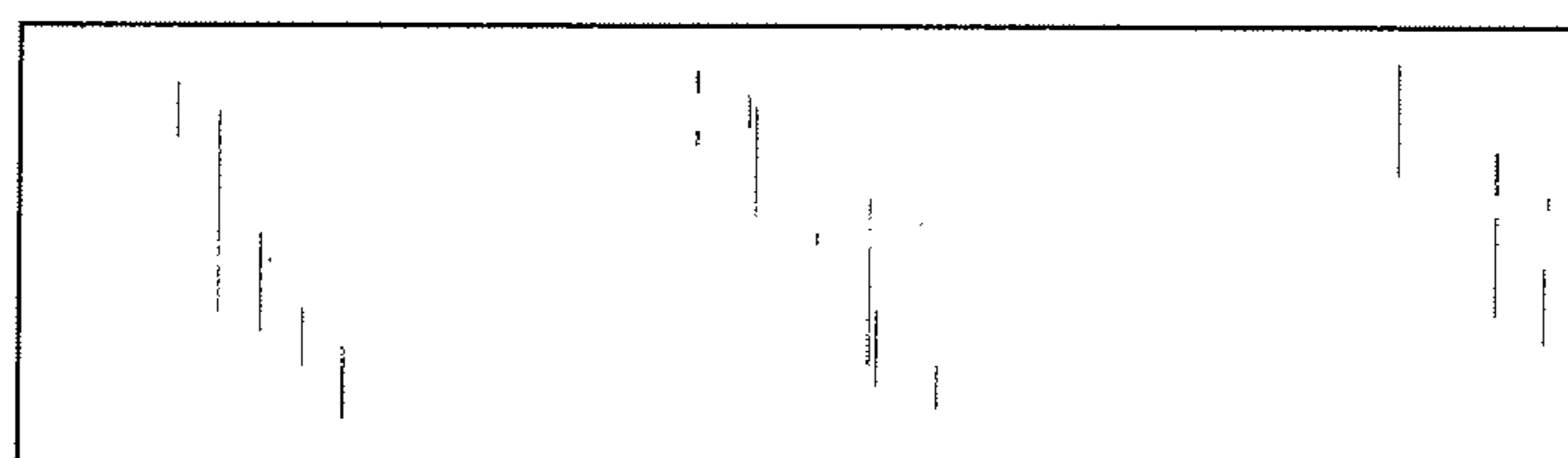

FIG. 11

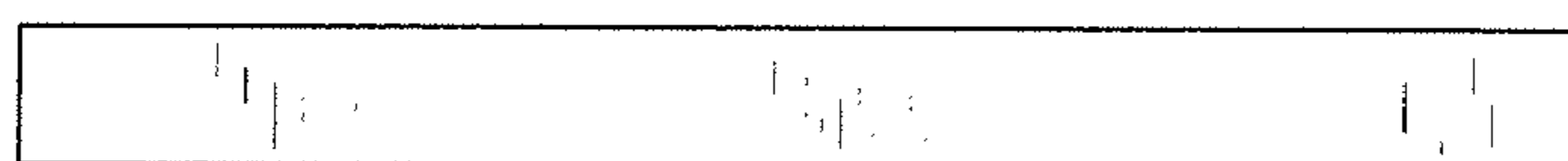

FIG. 12

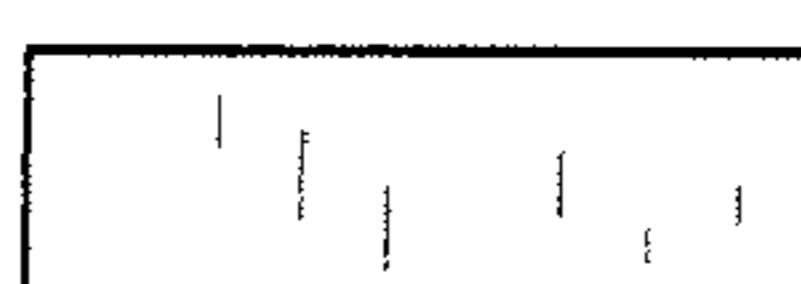

FIG. 13