



US00D561896S

(12) **United States Design Patent** (10) **Patent No.:** **US D561,896 S**  
**Jones** (45) **Date of Patent:** **\*\* Feb. 12, 2008**

(54) **GUIDEWIRE LOADER APPARATUS FOR A MEDICAL DEVICE**  
(75) Inventor: **Andrew Jones**, San Jose, CA (US)  
(73) Assignee: **Abbott Laboratories**, Abbott Park, IL (US)  
(\*\*) Term: **14 Years**  
(21) Appl. No.: **29/259,312**  
(22) Filed: **May 5, 2006**  
(51) **LOC (8) Cl.** ..... **24-02**  
(52) **U.S. Cl.** ..... **D24/130; D24/133**  
(58) **Field of Classification Search** ..... D24/112, D24/113, 129, 130, 133, 138, 144, 216; 604/528, 604/523, 158, 164.13, 164.01, 95.01, 95.04; 600/585, 434  
See application file for complete search history.

(56) **References Cited**  
U.S. PATENT DOCUMENTS  
4,757,827 A \* 7/1988 Buchbinder et al. .... 600/585  
4,799,496 A \* 1/1989 Hargreaves et al. .... 600/585  
4,907,332 A \* 3/1990 Christian et al. .... 29/237  
D343,678 S \* 1/1994 Snoke et al. .... D24/112  
D351,652 S \* 10/1994 Thompson et al. .... D24/138  
5,830,157 A \* 11/1998 Foote ..... 600/585  
6,030,360 A \* 2/2000 Biggs ..... 604/95.01  
6,190,333 B1 2/2001 Valencia  
6,652,506 B2 \* 11/2003 Bowe et al. .... 604/523  
6,869,417 B1 3/2005 Walters et al.  
6,879,854 B2 4/2005 Windheuser et al.  
7,048,711 B2 \* 5/2006 Rosenman et al. .... 604/95.04  
7,144,378 B2 \* 12/2006 Arnott ..... 600/585  
D534,650 S \* 1/2007 Inman et al. .... D24/133  
2004/0059369 A1 3/2004 Duffy et al.  
2006/0253048 A1 \* 11/2006 Jones et al. .... 600/585

FOREIGN PATENT DOCUMENTS  
EP 0328760 8/1989  
EP 0801955 A1 10/1997  
FR 2804608 8/2001

**OTHER PUBLICATIONS**

PCT patent application No. PCT/US2006/017750, International Search Report dated Oct. 6, 2006.

PCT patent application No. PCT/US2006/017750, Written Opinion dated Oct. 6, 2006.

\* cited by examiner

*Primary Examiner*—Ian Simmons  
*Assistant Examiner*—Carissa C Fitts  
(74) *Attorney, Agent, or Firm*—Beyer Weaver LLP.

(57) **CLAIM**

I claim the ornamental design for a guidewire loader apparatus for a medical device, as shown and described.

**DESCRIPTION**

FIG. 1 is a reduced top perspective view of a guidewire loader apparatus for a medical device showing my new design;

FIG. 2 is an exploded top perspective view thereof, showing a lower first component and an upper second component thereof;

FIG. 3 is an enlarged front elevation view of the perspective view of FIG. 1;

FIG. 4 is a top plan view of the lower component from the perspective view of FIG. 2, shown with the upper component removed for ease of illustration.

FIG. 5 is a bottom plan view thereof;

FIG. 6 is a front elevation view thereof;

FIG. 7 is a rear elevation view thereof;

FIG. 8 is a right side elevation view thereof;

FIG. 9 is a left side elevation view thereof;

FIG. 10 is a bottom plan view of the upper component from the perspective view of FIG. 2, shown with the lower component removed for ease of illustration.

FIG. 11 is a top plan view thereof;

FIG. 12 is a front elevation view thereof;

FIG. 13 is a rear elevation view thereof;

FIG. 14 is a right side elevation view thereof; and,

FIG. 15 is a left side elevation view thereof.

**1 Claim, 7 Drawing Sheets**

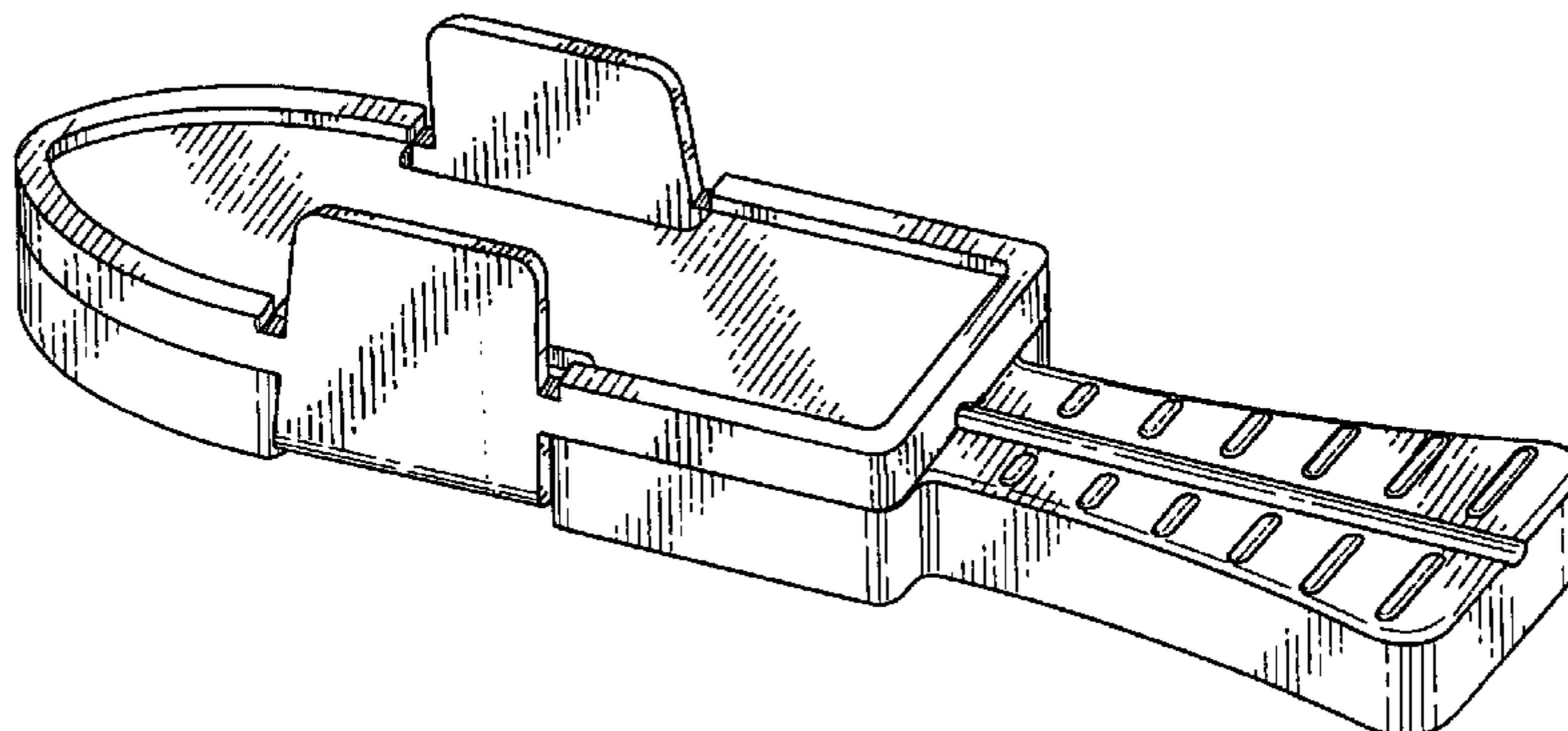

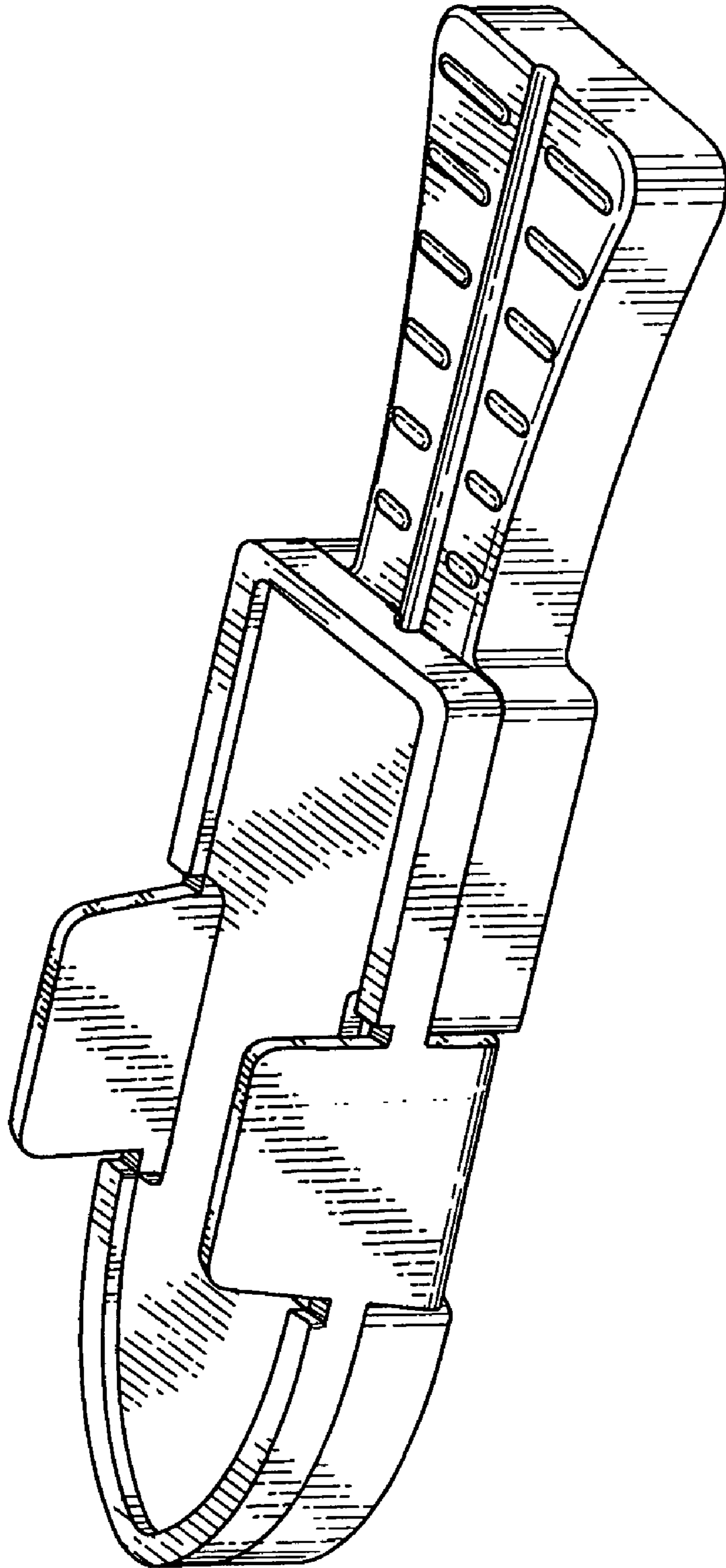

FIG. 1

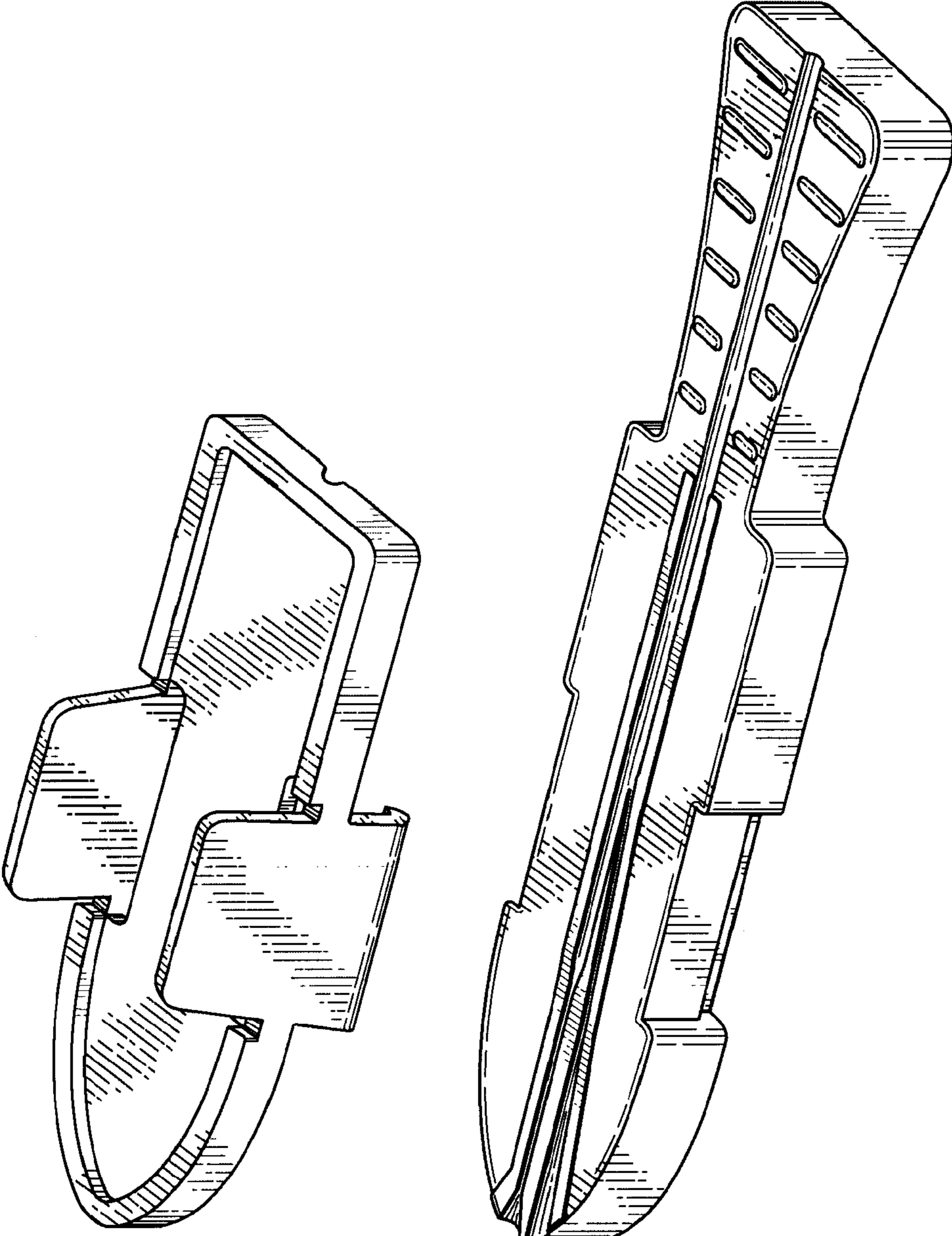

FIG. 2

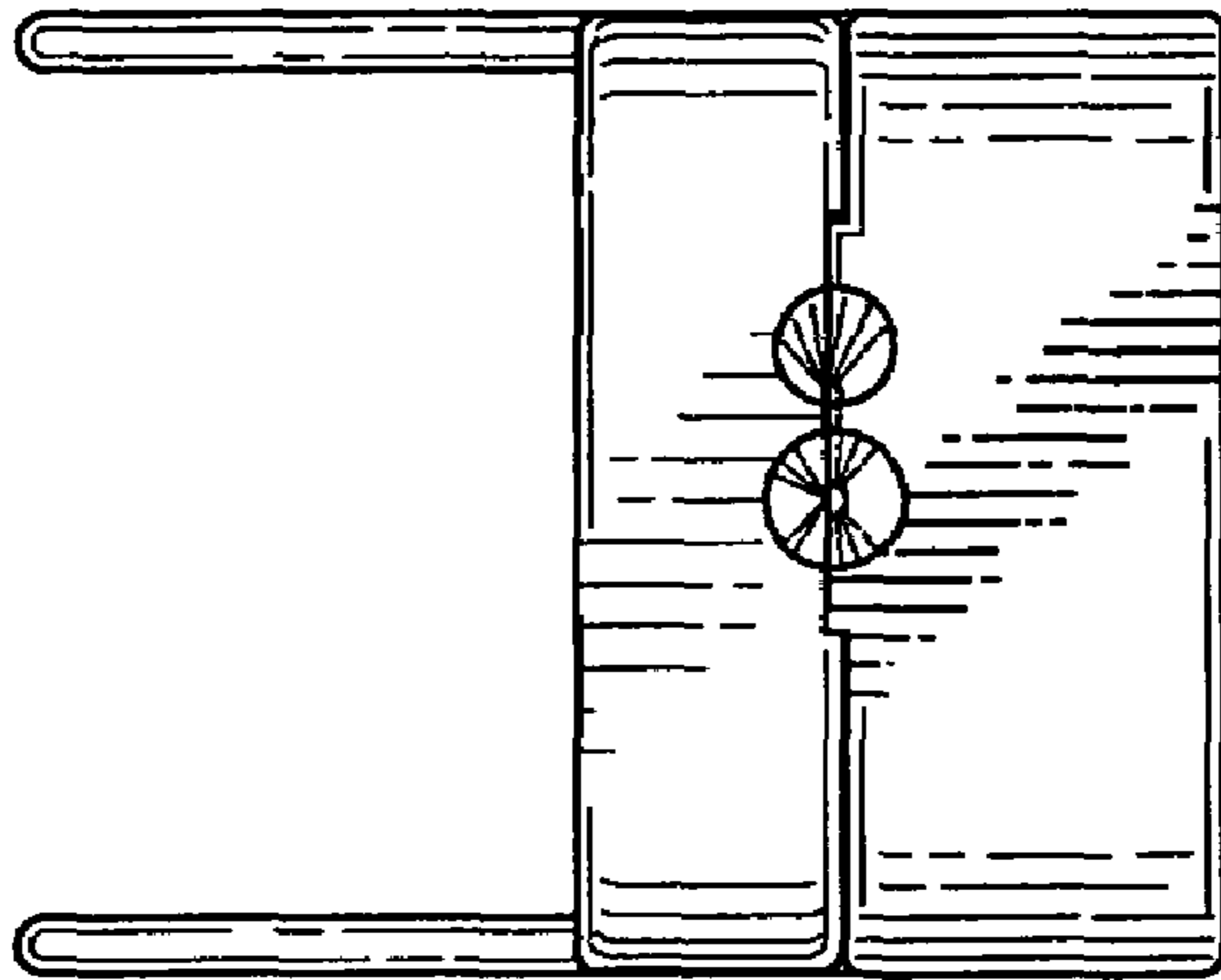

FIG. 3



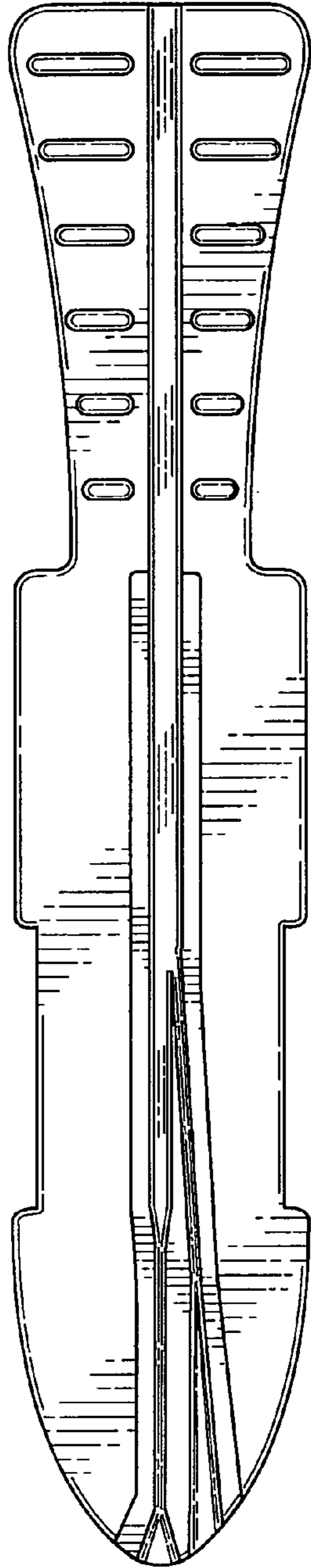

FIG. 4

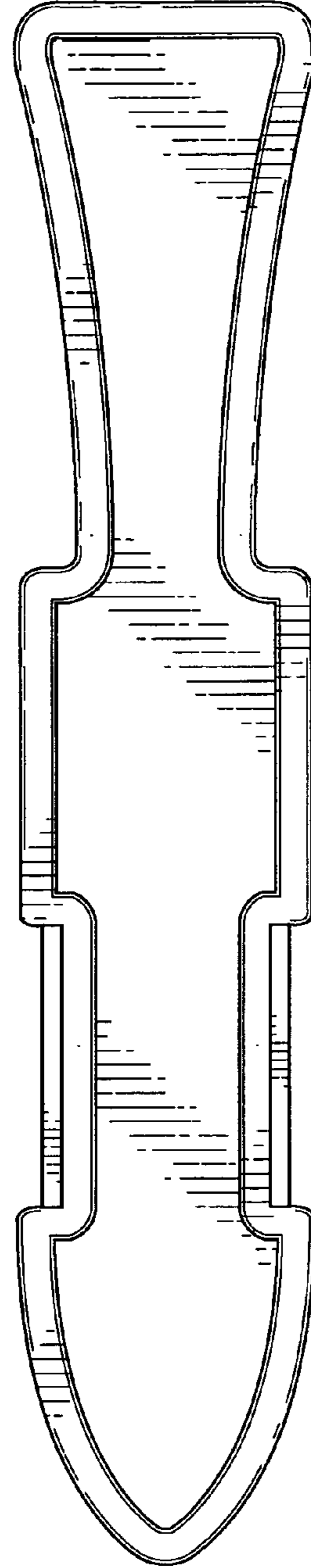

FIG. 5

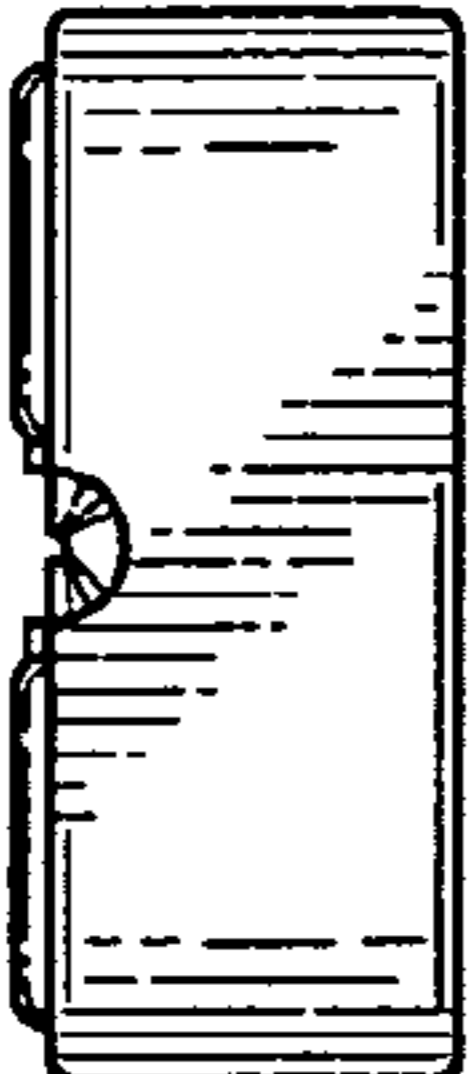

FIG. 6

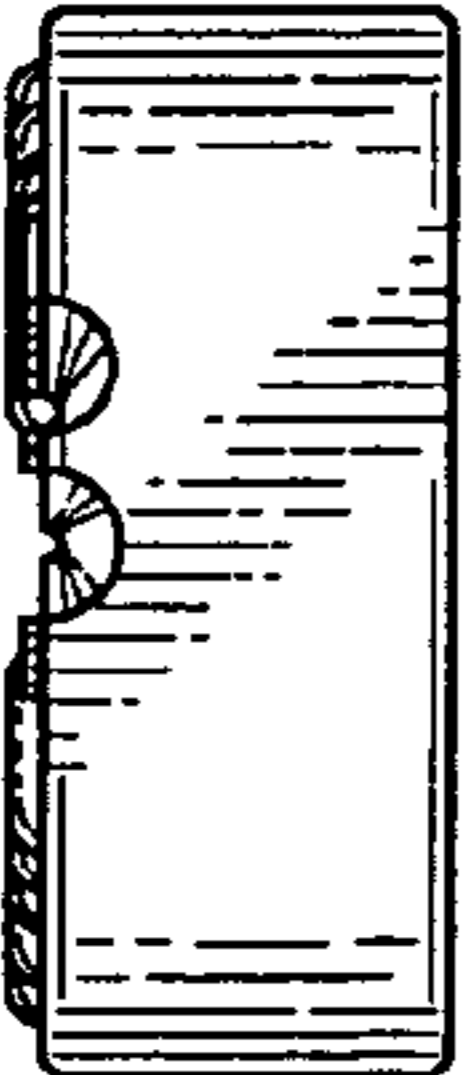

FIG. 7



FIG. 8



FIG. 9

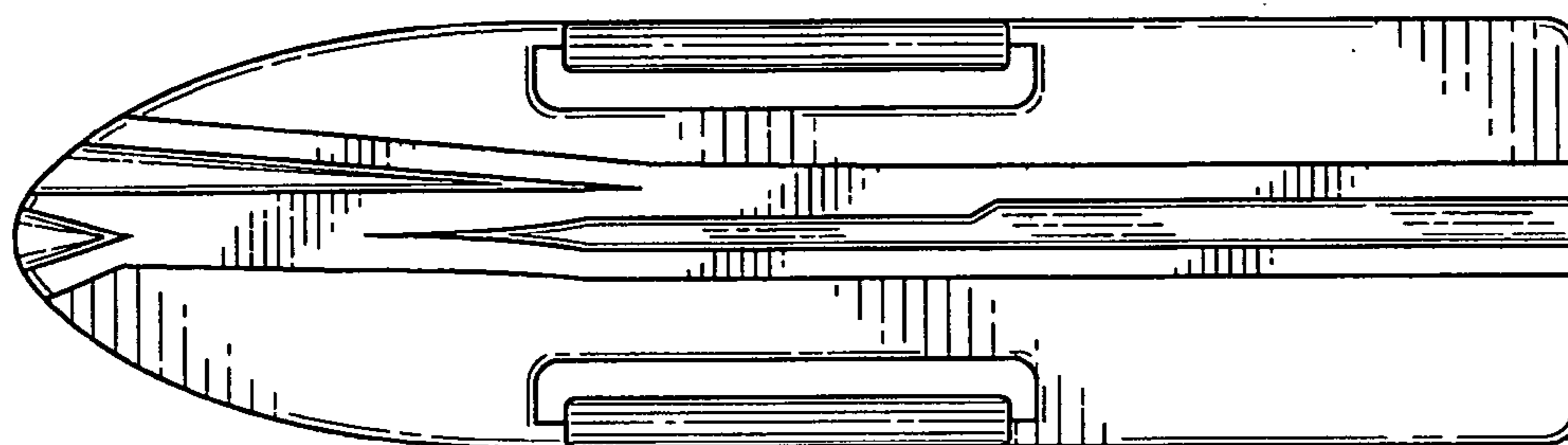

FIG. 10

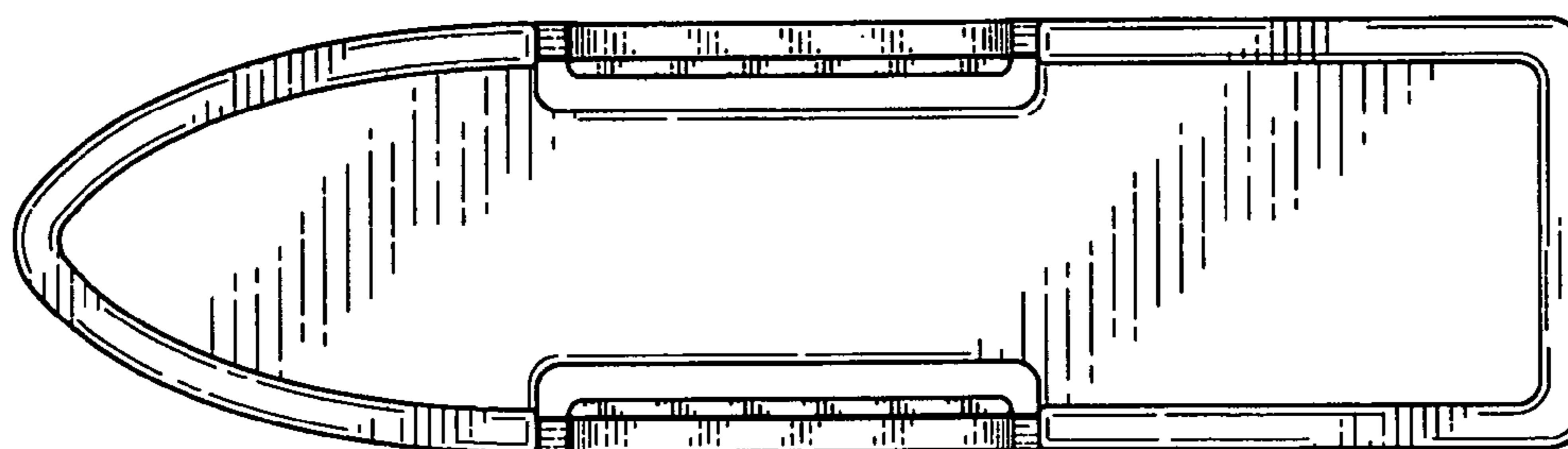

FIG. 11

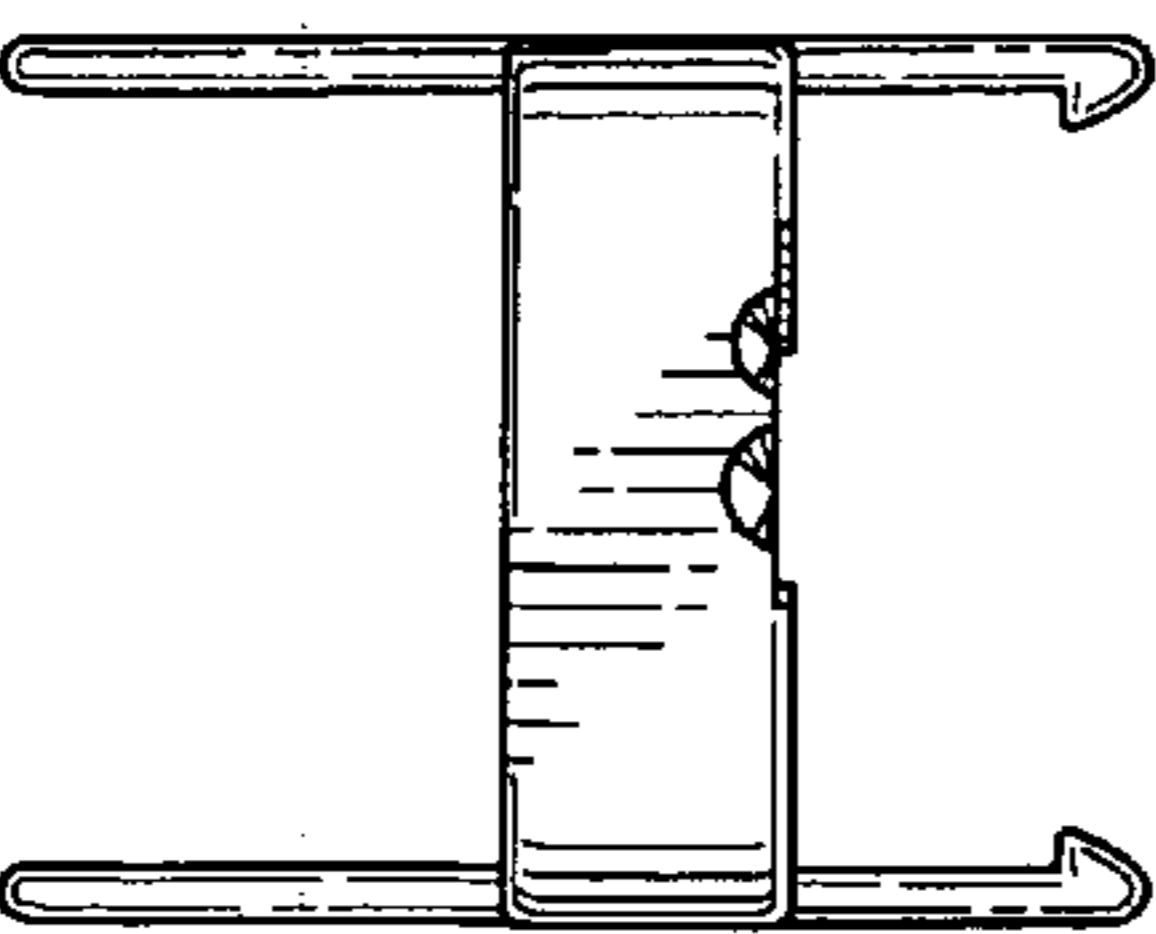

FIG. 12

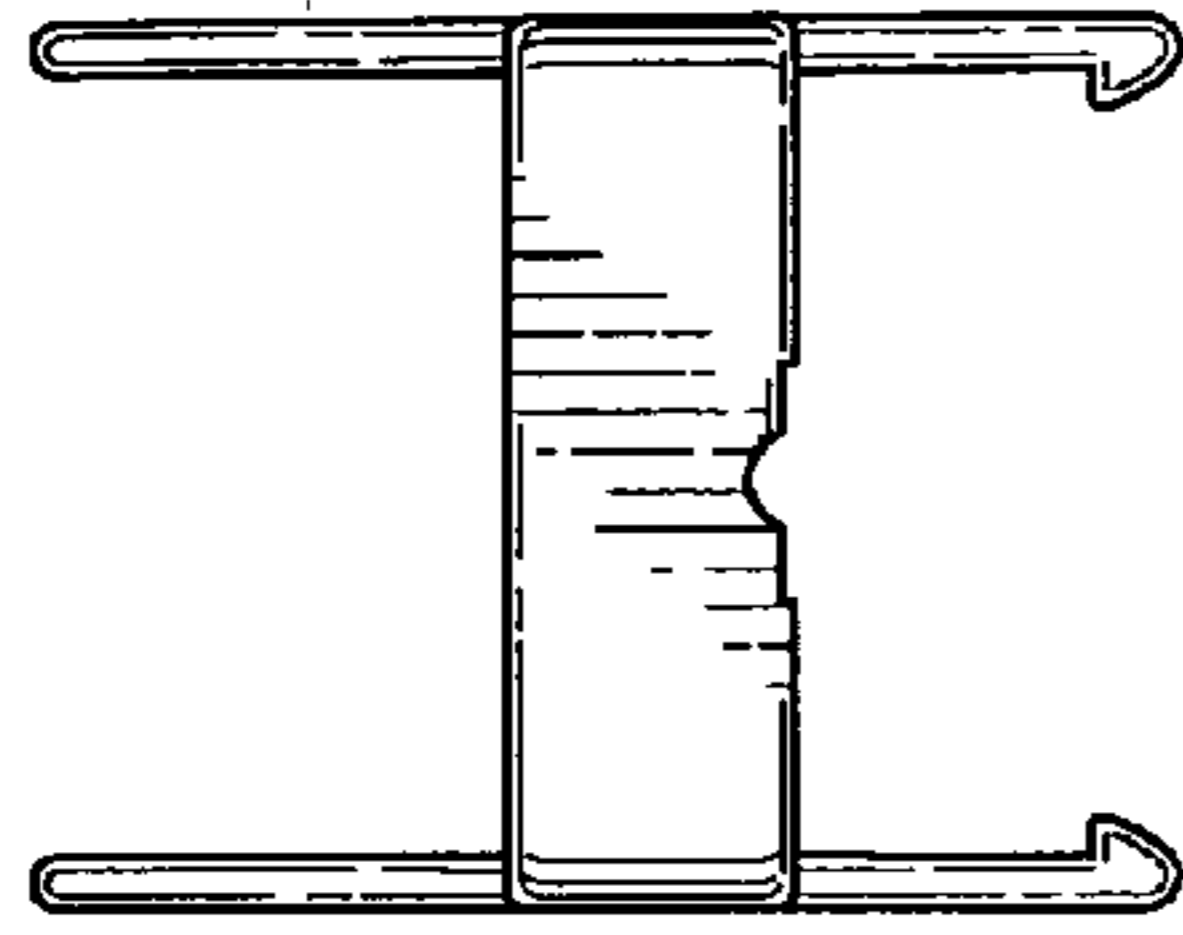

FIG. 13

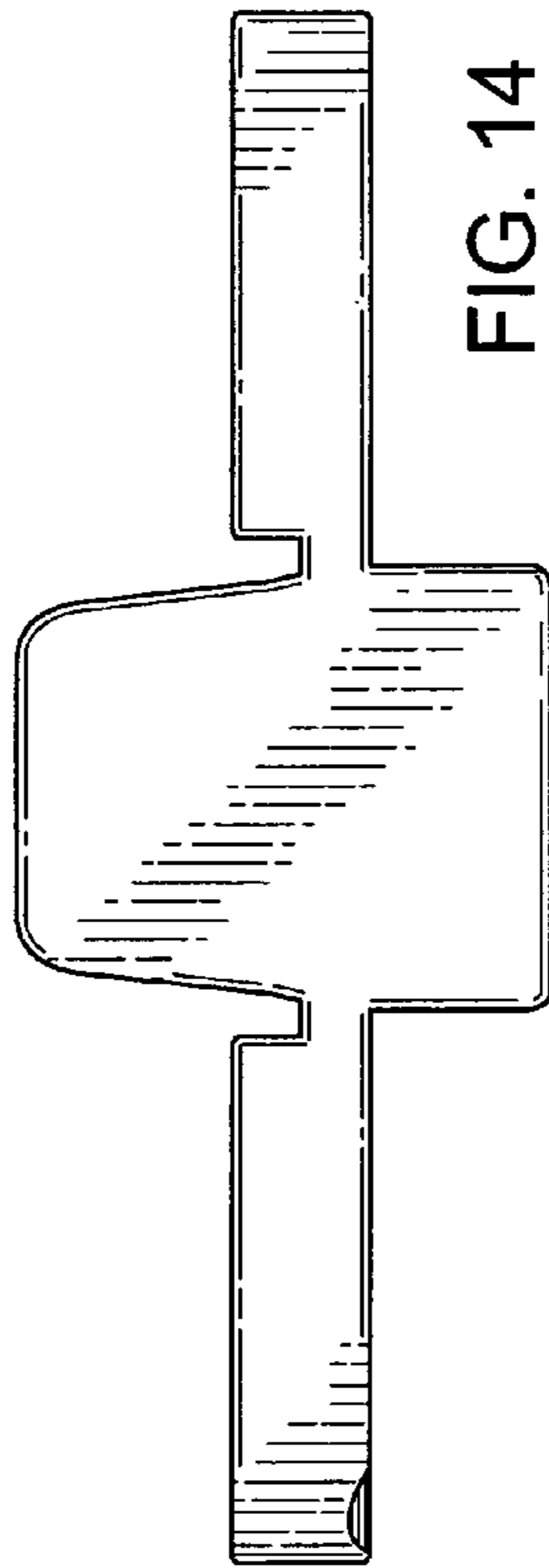

FIG. 14

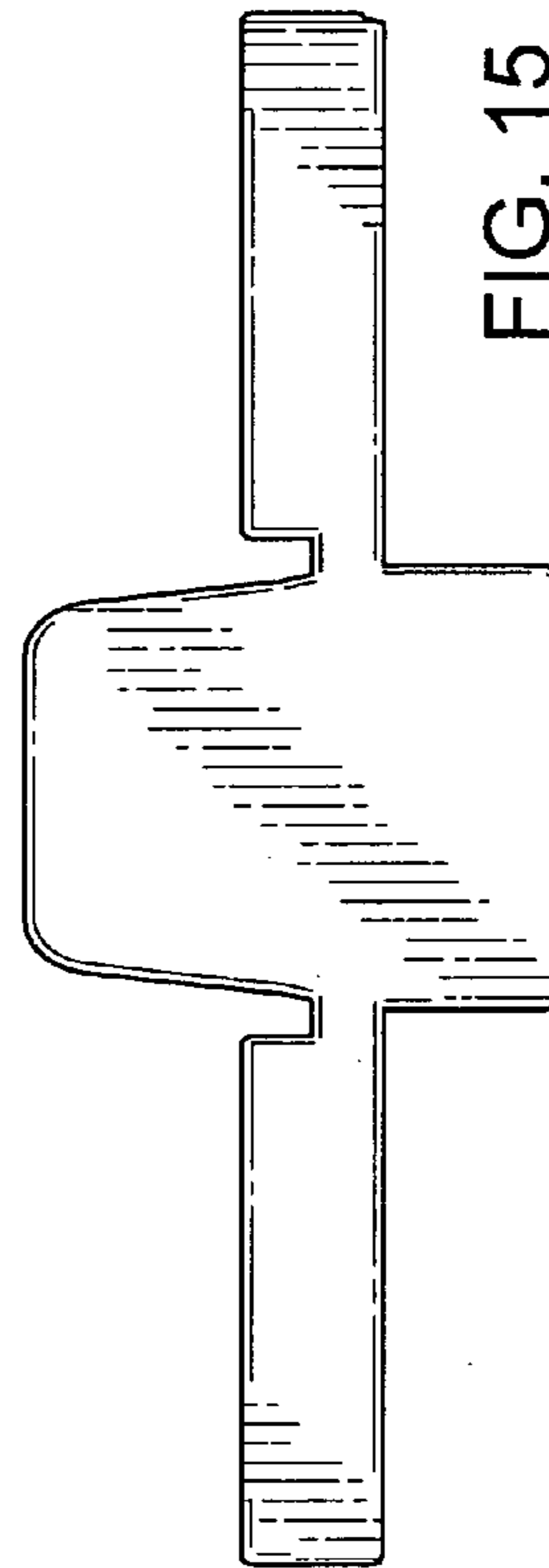

FIG. 15