

US00D561885S

(12) **United States Design Patent**  
**Furner et al.**

(10) **Patent No.:** **US D561,885 S**  
(45) **Date of Patent:** **\*\* Feb. 12, 2008**

(54) **COVER FOR A SPRAY DISPENSER**

(75) Inventors: **Paul E. Furner**, Racine, WI (US);  
**Amelia H. Majerowski**, Kenosha, WI (US);  
**Kenneth W. Michaels**, Spring Grove, IL (US);  
**Evan A. Sparks**, Madison, WI (US)

(73) Assignee: **S.C. Johnson & Son, Inc.**, Racine, WI (US)

(\*\*) Term: **14 Years**

(21) Appl. No.: **29/279,238**

(22) Filed: **Apr. 24, 2007**

(51) **LOC (8) Cl.** ..... **28-99**

(52) **U.S. Cl.** ..... **D23/366**

(58) **Field of Classification Search** ..... 261/DIG. 17,  
261/DIG. 42, DIG. 65, DIG. 88, DIG. 89;  
D23/355-369; D28/5, 6; 392/386, 390,  
392/392, 393, 394, 401; 239/34, 35, 37,  
239/41, 42, 43, 53-58, 60, 136, 326

See application file for complete search history.

(56) **References Cited**

**U.S. PATENT DOCUMENTS**

- D425,190 S \* 5/2000 Morikawa ..... D23/366
- D471,970 S \* 3/2003 Gallagher et al. .... D23/366
- D478,003 S \* 8/2003 Bodker et al. .... D9/417
- D535,004 S \* 1/2007 Furner et al. .... D23/366
- D537,929 S \* 3/2007 Muderlak et al. .... D23/366

- D538,915 S \* 3/2007 Anderson et al. .... D23/366
- D546,434 S \* 7/2007 Barraclough ..... D23/366
- D548,824 S \* 8/2007 Christianson ..... D23/364

\* cited by examiner

*Primary Examiner*—Sandra Snapp

(57) **CLAIM**

The ornamental design for a cover for a spray dispenser, as shown and described herein.

**DESCRIPTION**

FIG. 1 is an isometric view of a top, front, and left side of an ornamental design for a cover for a spray dispenser further illustrating in dashed lines one type of dispenser having an actuator on which the cover of the present invention may be disposed;

FIG. 2 is a front elevational view of the cover of FIG. 1;

FIG. 3 is a rear elevational view of the cover of FIG. 1 further illustrating in dashed lines a hinge disposed on the cover;

FIG. 4 is a right side elevational view of the cover of FIG. 1;

FIG. 5 is a left side elevational view of the cover of FIG. 1;

FIG. 6 is a top plan view of the cover of FIG. 1; and,

FIG. 7 is a bottom plan view of the cover of FIG. 1.

The subject matter shown above in dashed lines forms no part of the claimed invention.

**1 Claim, 6 Drawing Sheets**



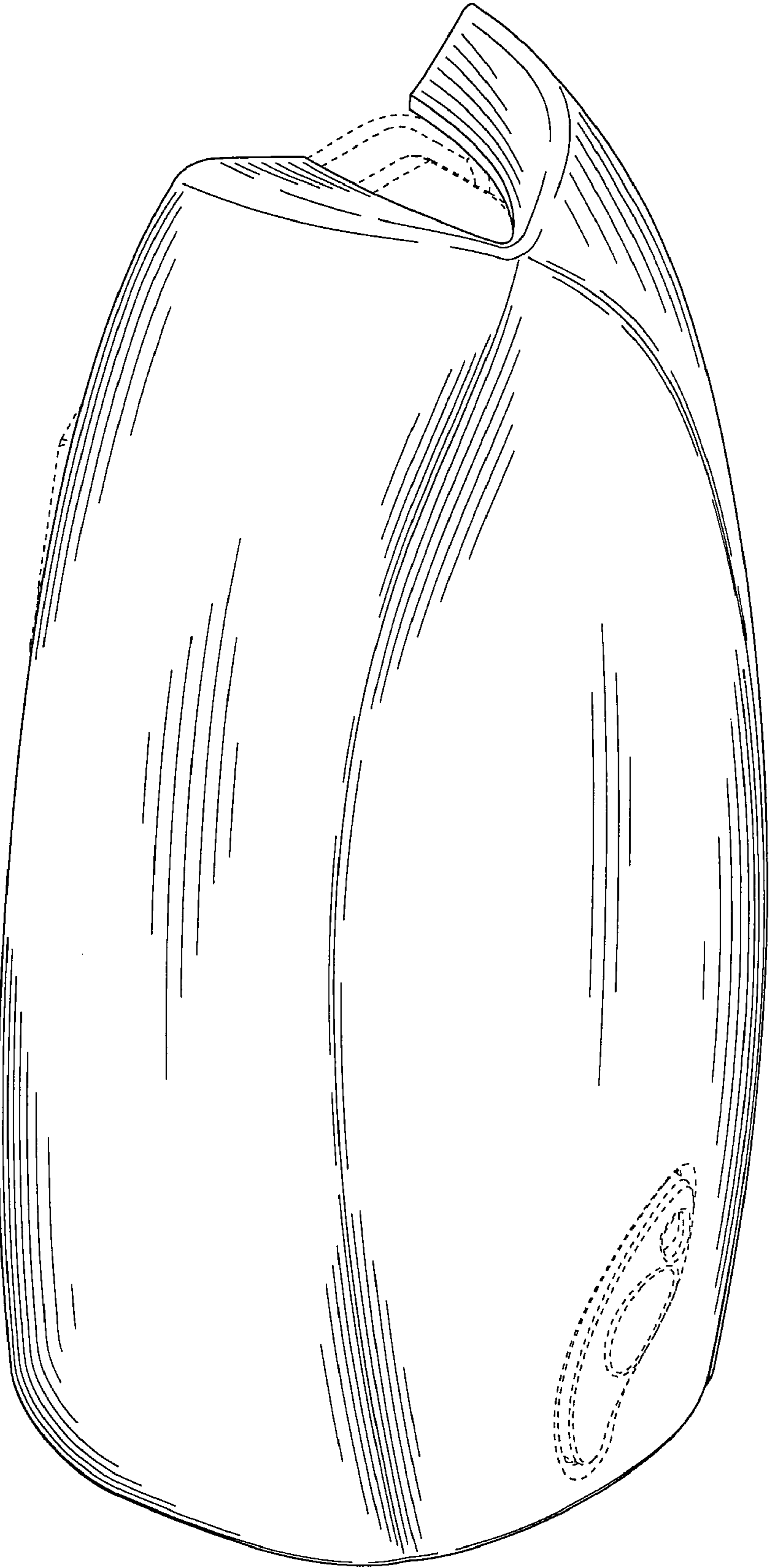

FIG. 1

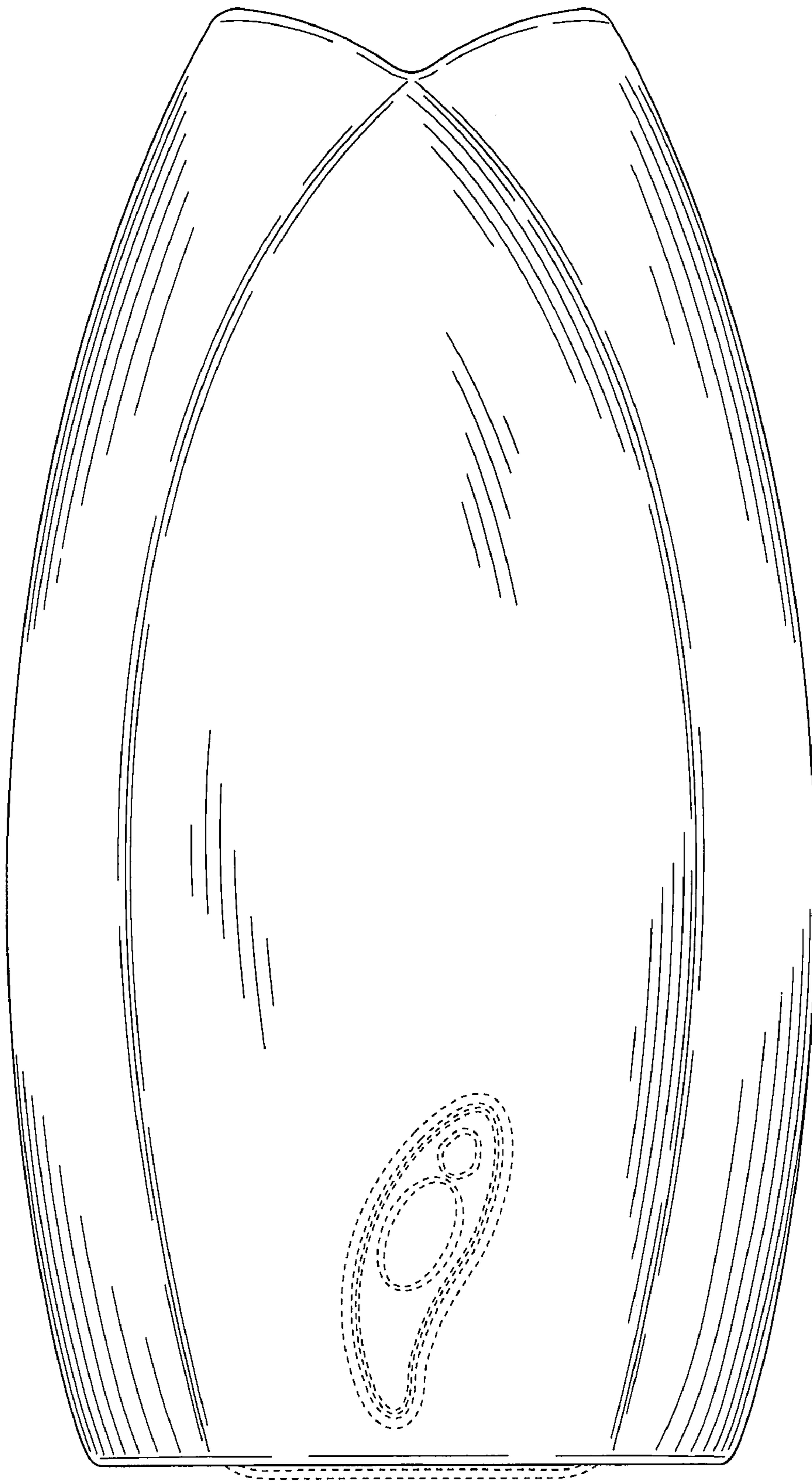

FIG. 2

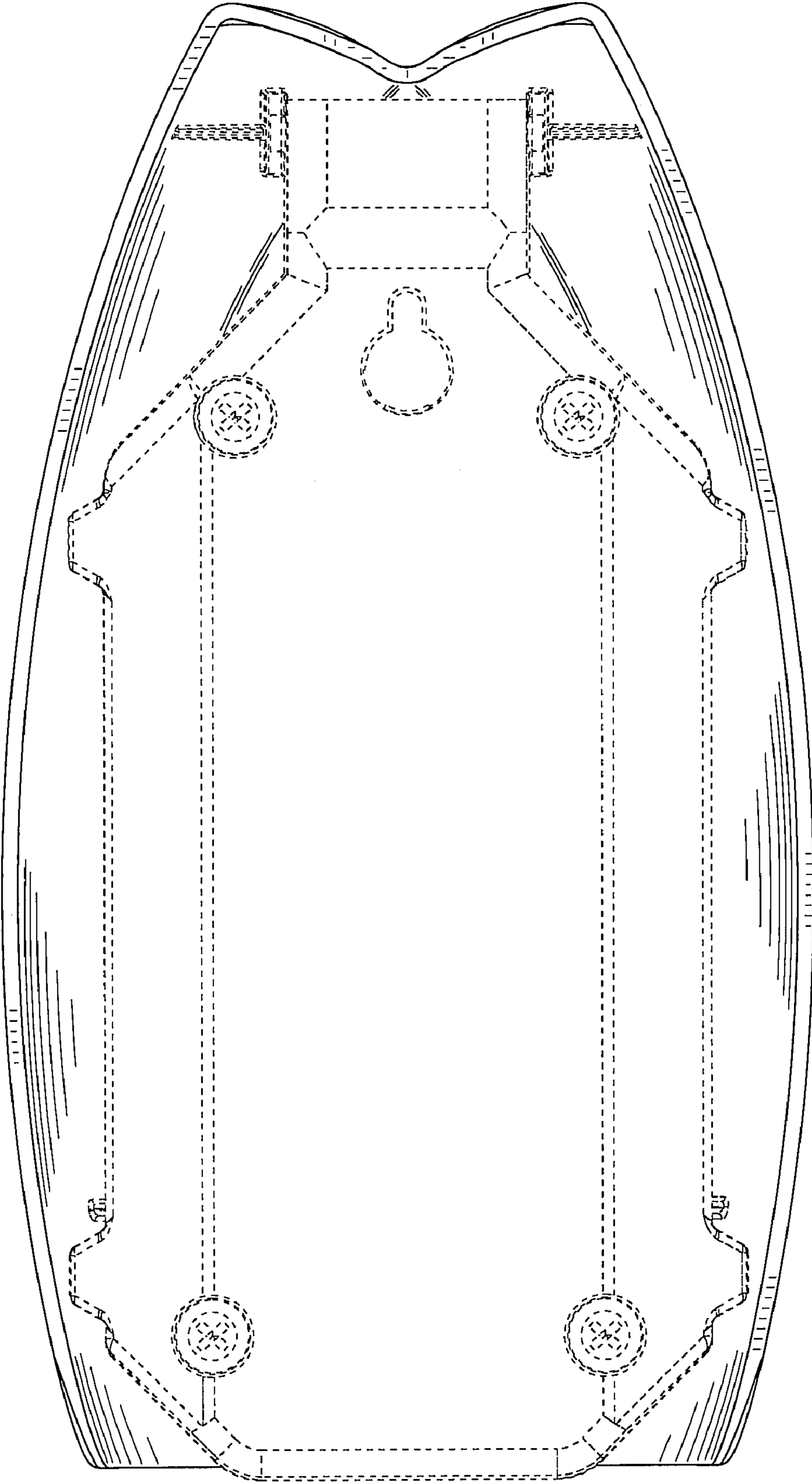

FIG. 3

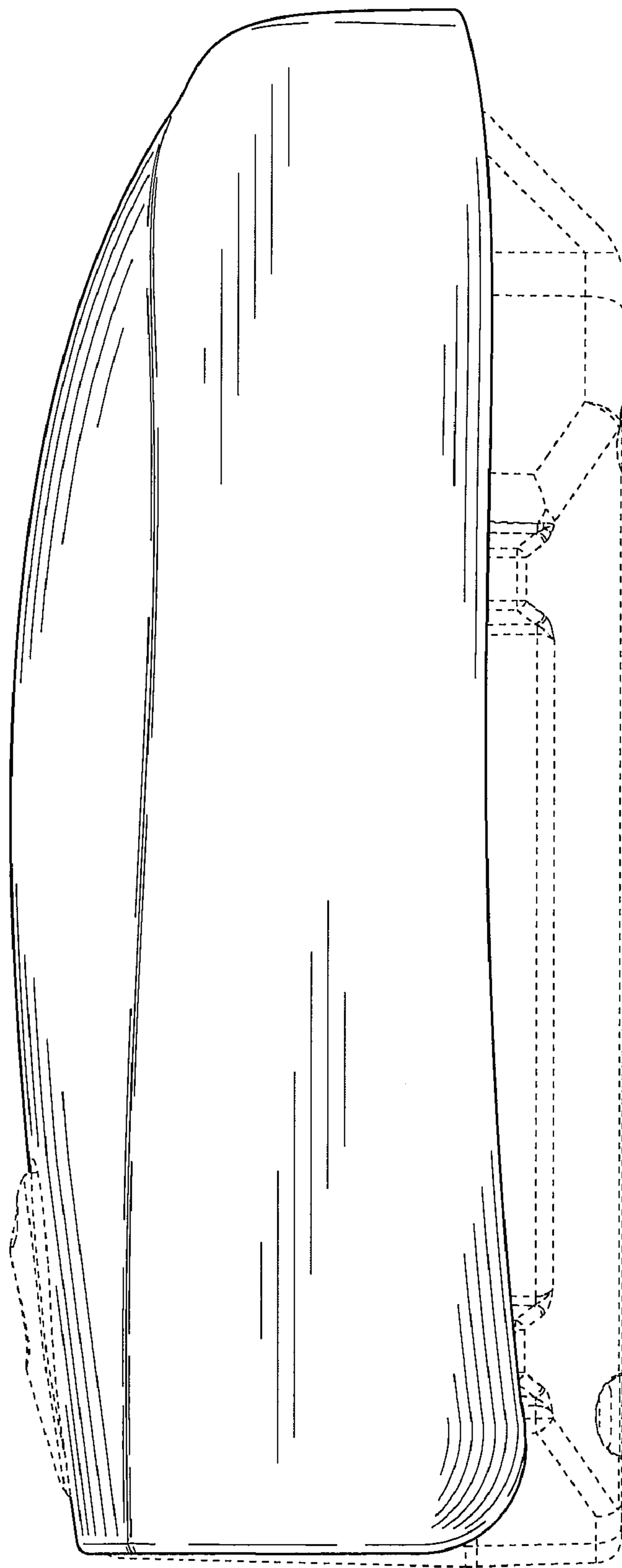

FIG. 4

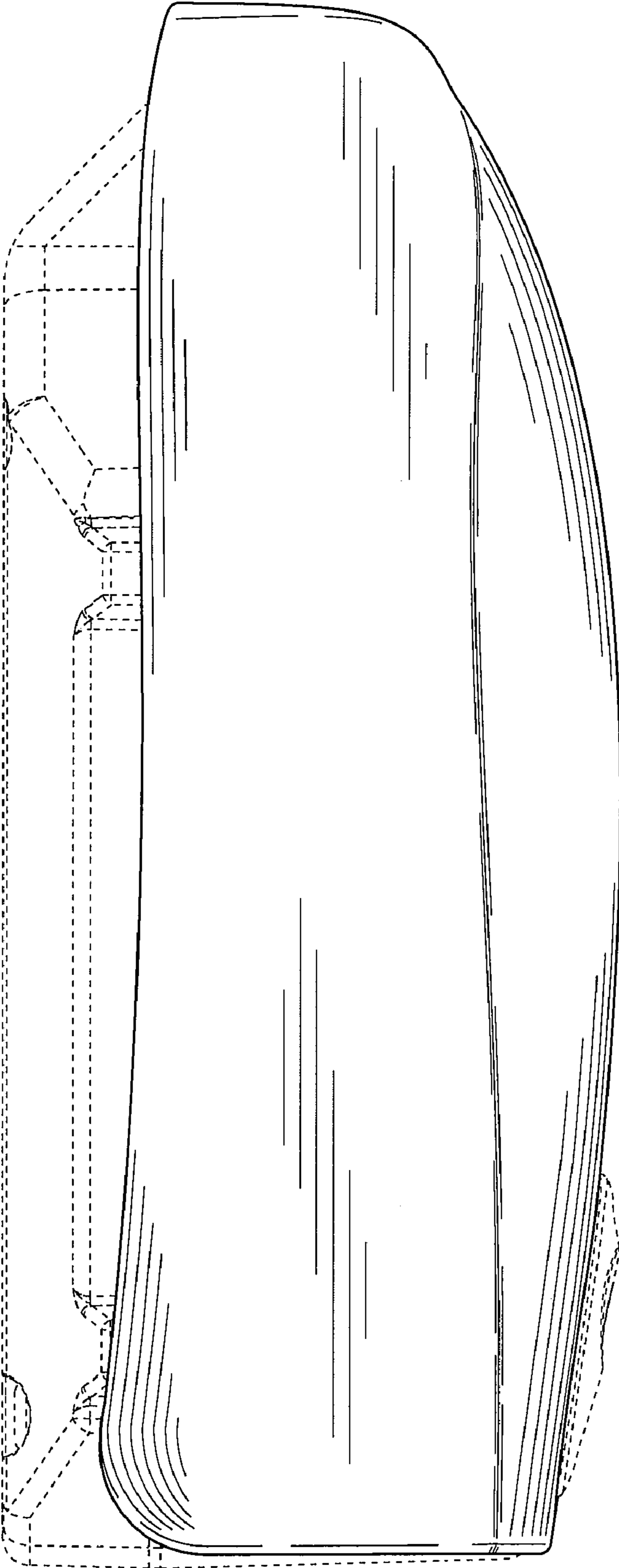

FIG. 5

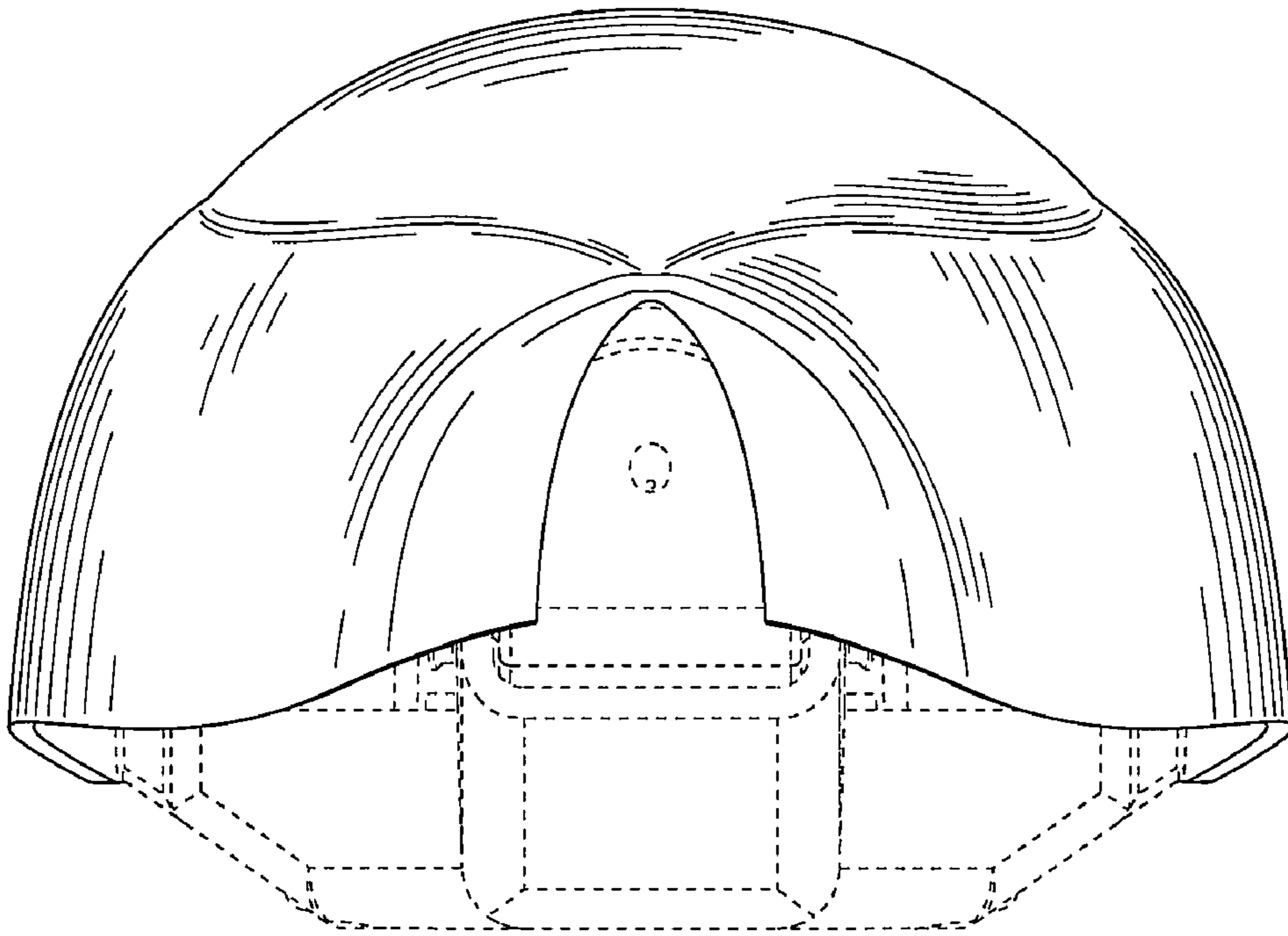

FIG. 6

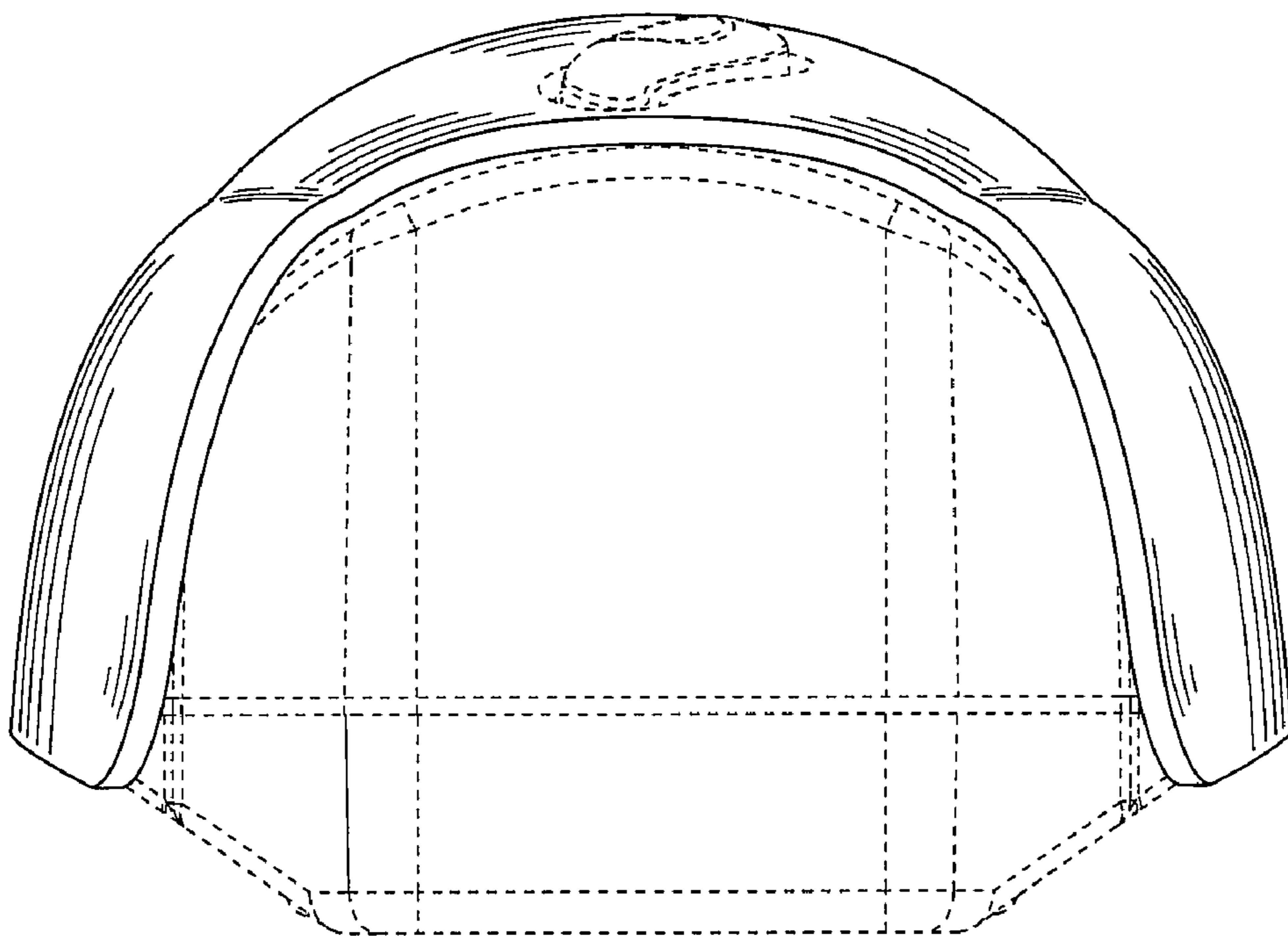

FIG. 7