



US00D561884S

(12) **United States Design Patent**
Furner et al.

(10) **Patent No.:** **US D561,884 S**
(45) **Date of Patent:** **** Feb. 12, 2008**

(54) **COVER AND ACTUATOR FOR A SPRAY DISPENSER**

D546,434 S * 7/2007 Barraclough D23/366
D548,824 S * 8/2007 Christianson D23/364

* cited by examiner

(75) Inventors: **Paul E. Furner**, Racine, WI (US);
Amelia H. Majerowski, Kenosha, WI (US);
Kenneth W. Michaels, Spring Grove, IL (US);
Evan A. Sparks, Madison, WI (US)

Primary Examiner—Sandra Snapp

(73) Assignee: **S.C. Johnson & Son, Inc.**, Racine, WI (US)

(57) **CLAIM**

The ornamental design for a cover and actuator for a spray dispenser, as shown and described herein.

(**) Term: **14 Years**

DESCRIPTION

(21) Appl. No.: **29/279,236**

FIG. 1 is an isometric view of a top, front, and left side of an ornamental design for a cover and actuator for a spray dispenser further illustrating in dashed lines one type of dispenser on which the cover and the actuator of the present invention may be disposed;

(22) Filed: **Apr. 24, 2007**

FIG. 2 is a front elevational view of the cover and the actuator of FIG. 1;

(51) **LOC (8) Cl.** **28-99**

(52) **U.S. Cl.** **D23/366**

(58) **Field of Classification Search** 261/DIG. 17,
261/DIG. 42, DIG. 65, DIG. 88, DIG. 89;
D23/355-369; D28/5, 6; 392/386, 390,
392/392, 393, 394, 401; 239/34, 35, 37,
239/41, 42, 43, 53-58, 60, 136, 326

FIG. 3 is a rear elevational view of the cover of FIG. 1 further illustrating in dashed lines a hinge disposed on the cover;

FIG. 4 is a right side elevational view of the cover and the actuator of FIG. 1;

See application file for complete search history.

FIG. 5 is a left side elevational view of the cover and the actuator of FIG. 1;

(56) **References Cited**

U.S. PATENT DOCUMENTS

D425,190 S * 5/2000 Morikawa D23/366
D471,970 S * 3/2003 Gallagher et al. D23/366
D478,003 S * 8/2003 Bodker et al. D9/417
D535,004 S * 1/2007 Furner et al. D23/366
D537,929 S * 3/2007 Muderlak et al. D23/366
D538,915 S * 3/2007 Anderson et al. D23/366

FIG. 6 is a top plan view of the cover of FIG. 1; and,

FIG. 7 is a bottom plan view of the cover and the actuator of FIG. 1.

The subject matter shown above in dashed lines forms no part of the claimed invention.

1 Claim, 6 Drawing Sheets

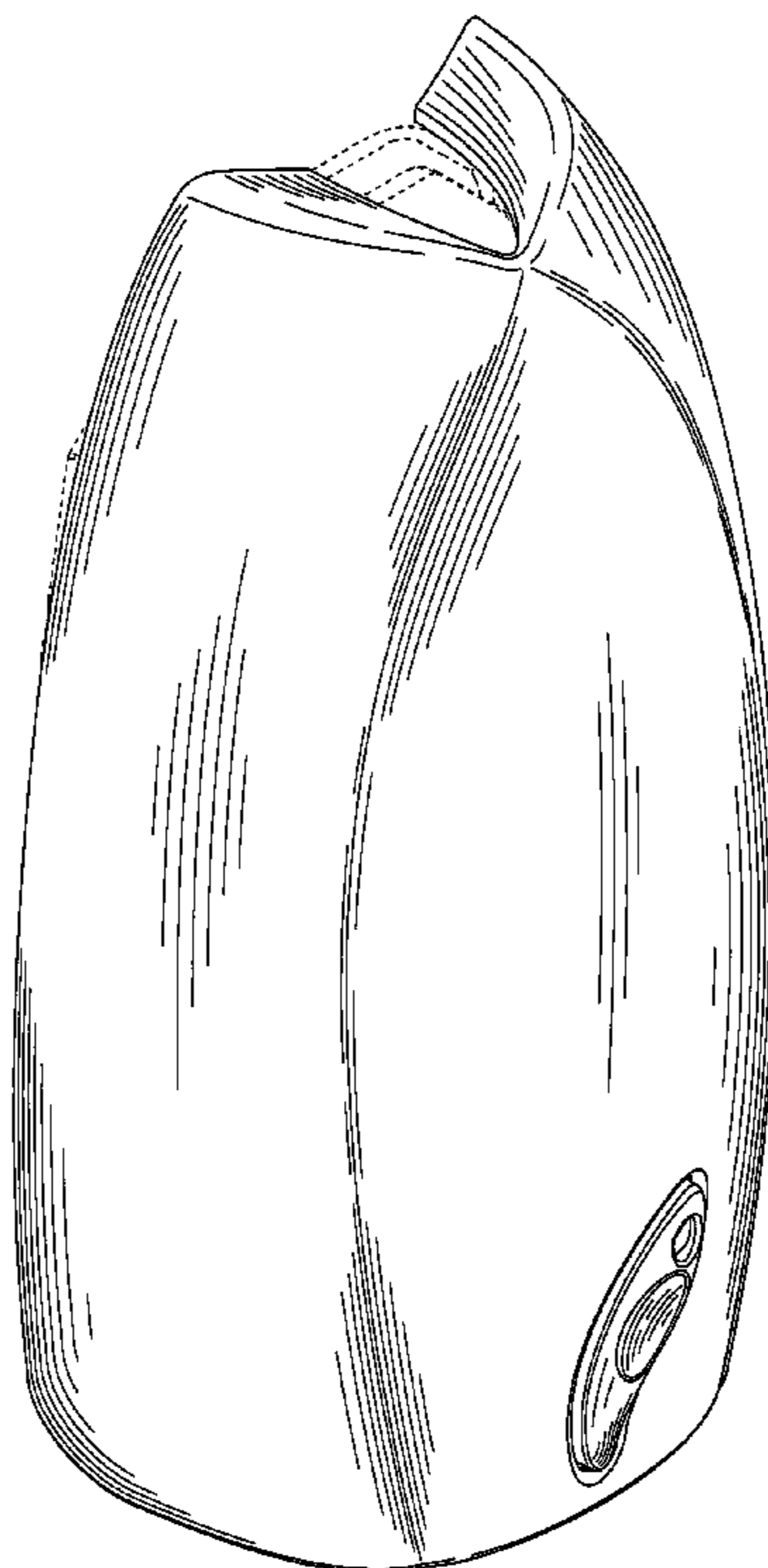

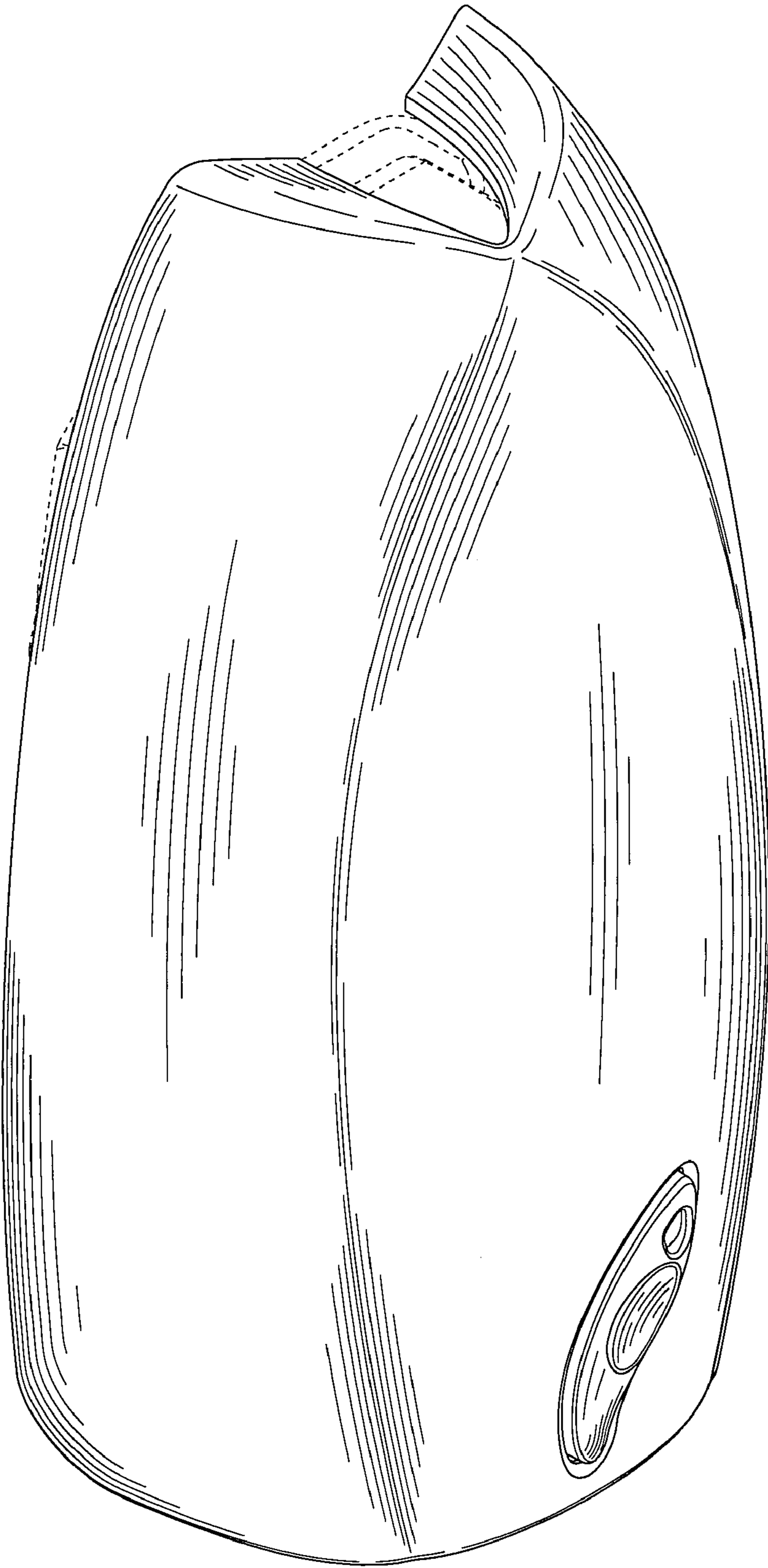

FIG. 1

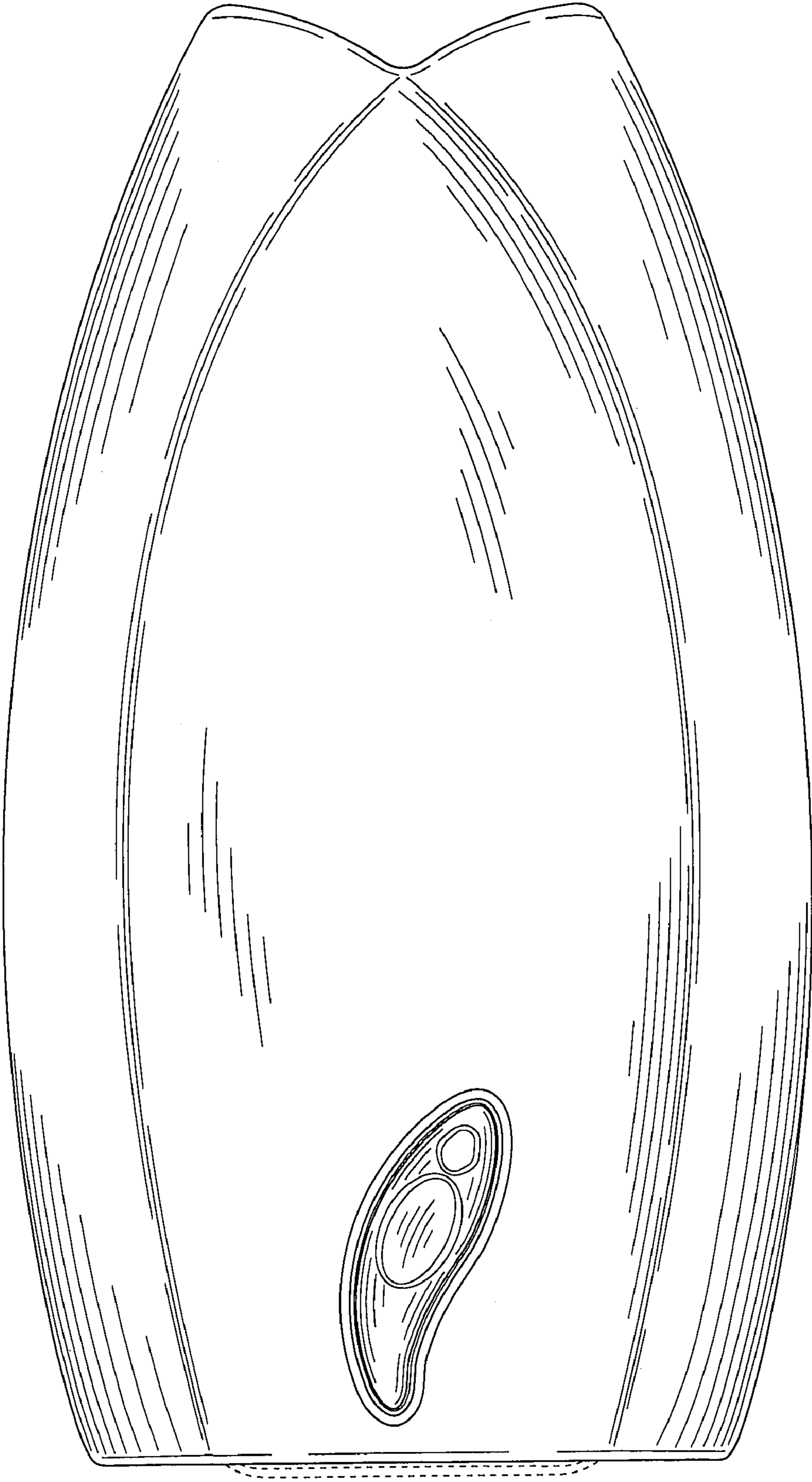

FIG. 2

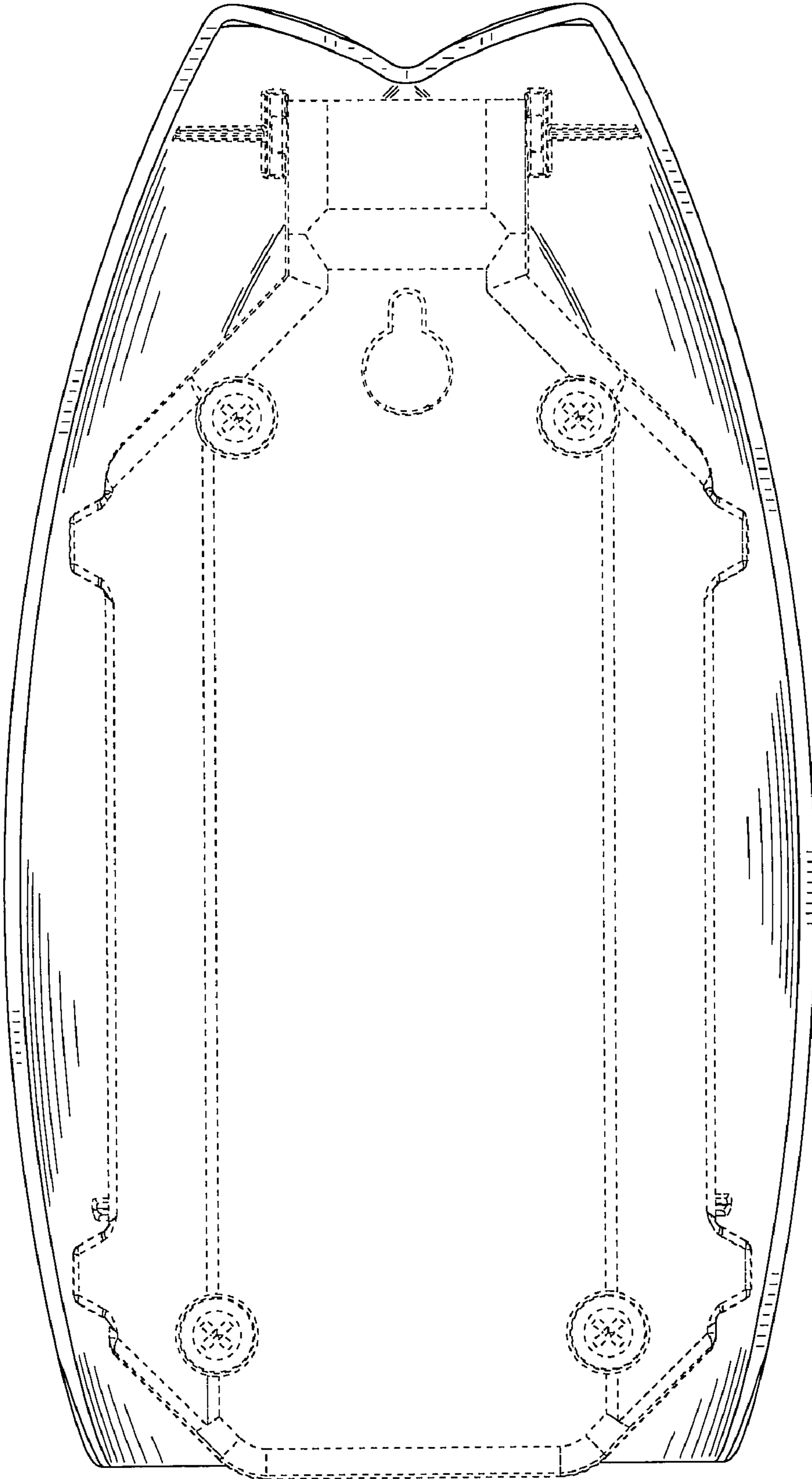

FIG. 3

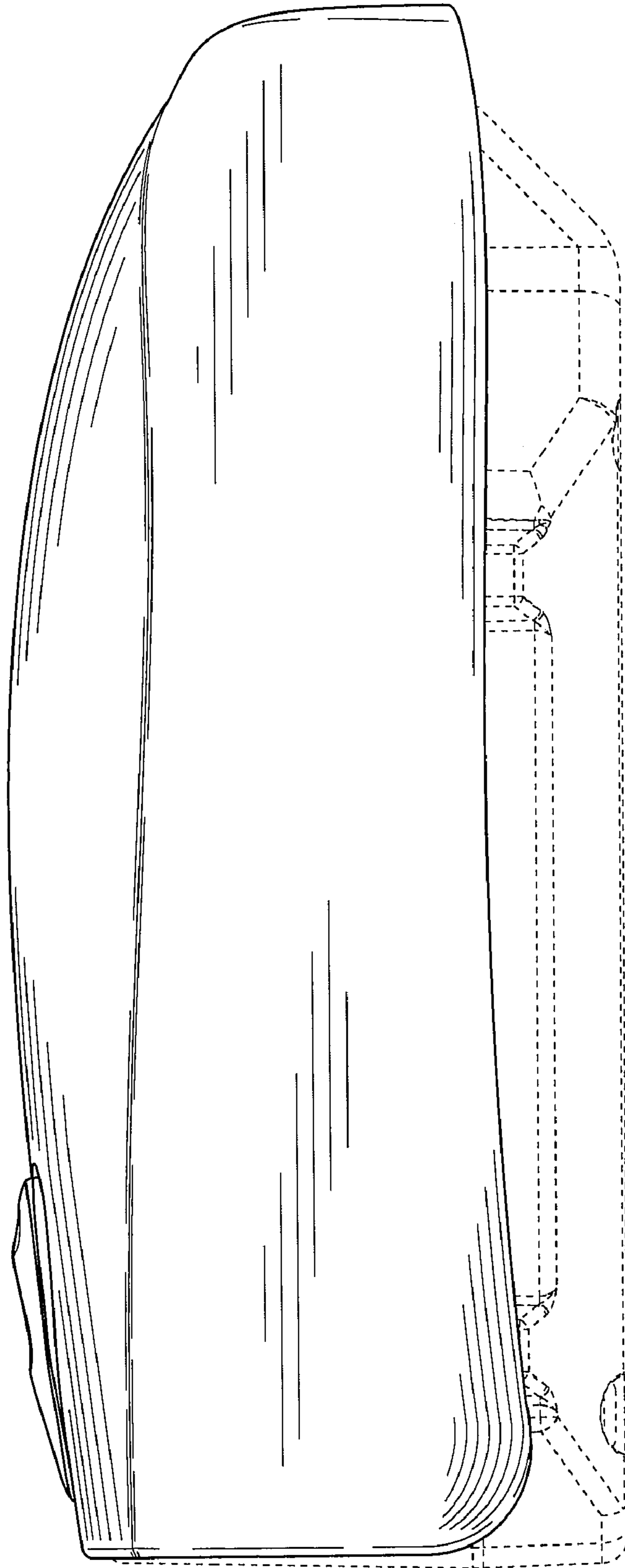

FIG. 4

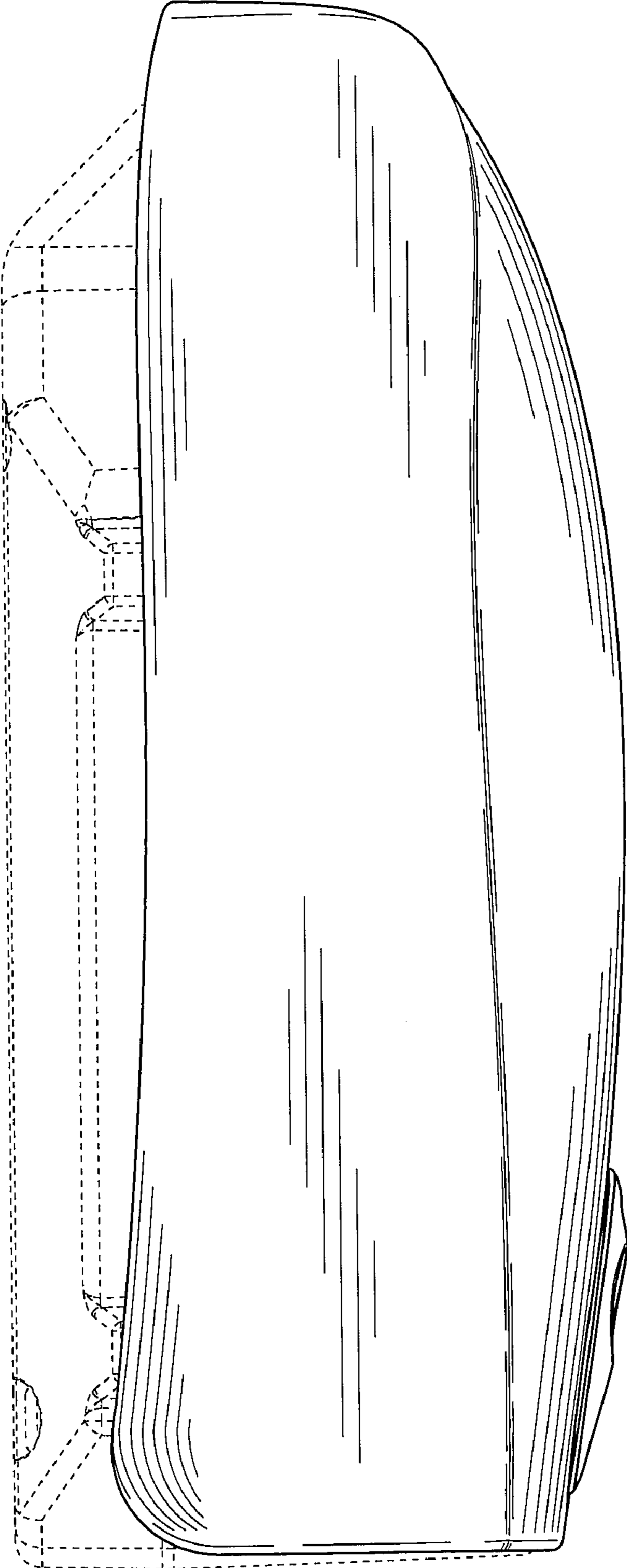

FIG. 5

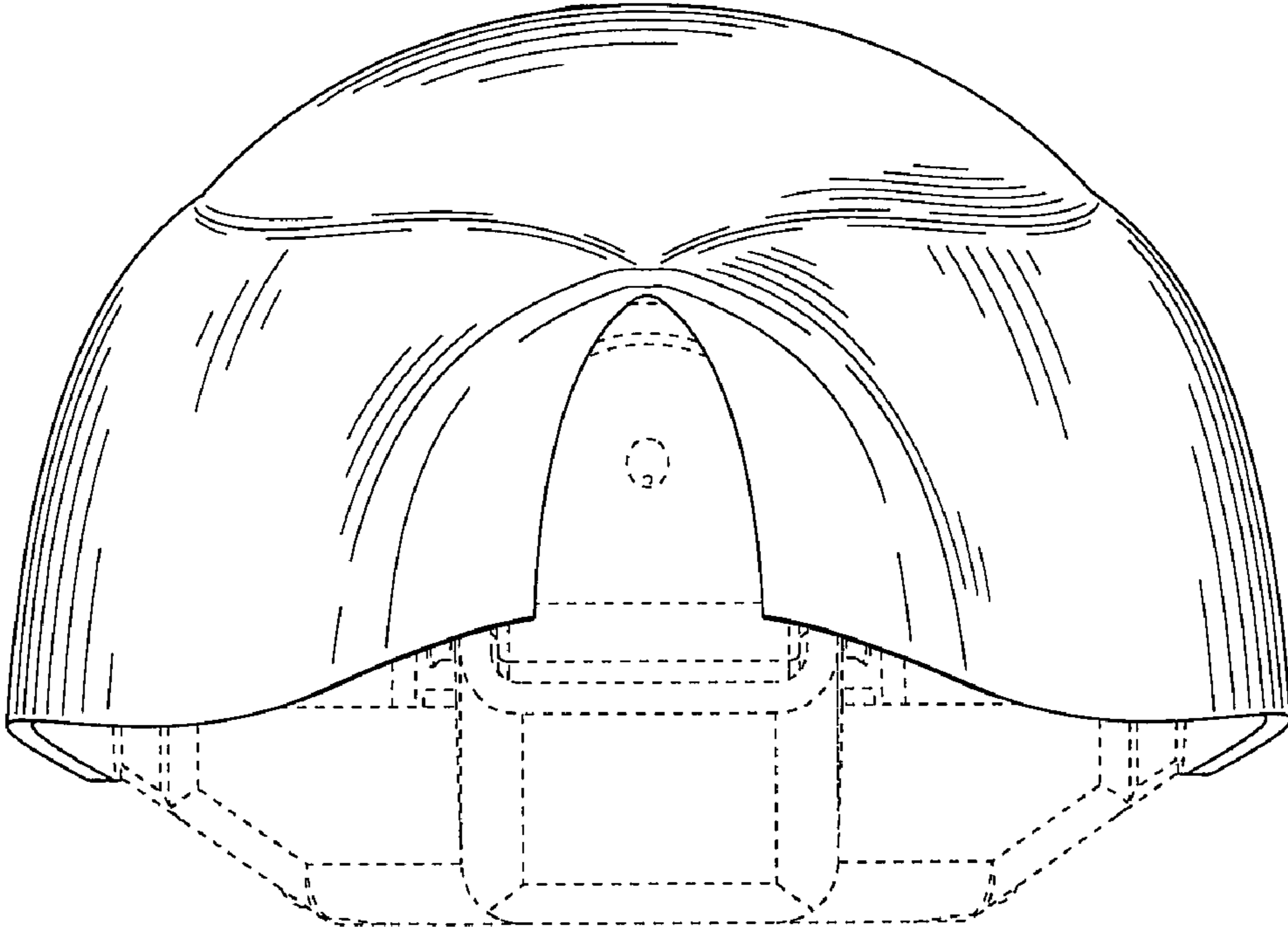

FIG. 6

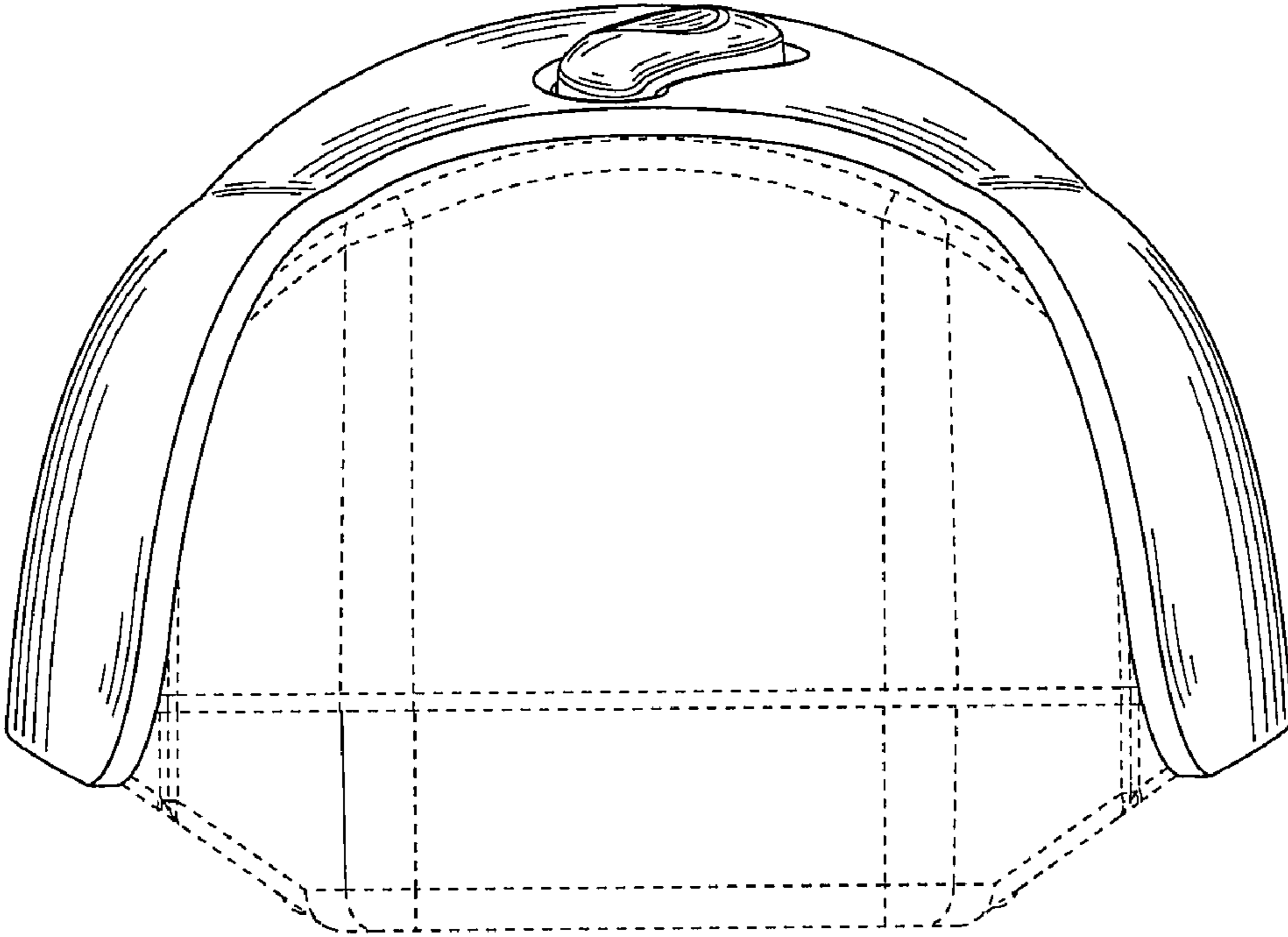

FIG. 7