

US00D561841S

(12) **United States Design Patent**
Baazov et al.

(10) **Patent No.:** **US D561,841 S**

(45) **Date of Patent:** **** Feb. 12, 2008**

(54) **POKER TABLE**

(75) Inventors: **David Baazov**, Dollard-Des-Ormeaux
(CA); **Albert Jann**, Cote Saint Luc
(CA)

(73) Assignee: **Amaya Gaming Group Inc.**,
Mont-Royal (Quebec) (CA)

(**) Term: **14 Years**

(21) Appl. No.: **29/262,888**

(22) Filed: **Jul. 13, 2006**

(51) **LOC (8) Cl.** **21-01**

(52) **U.S. Cl.** **D21/369**

(58) **Field of Classification Search** D6/451,
D6/486, 488, 511; D21/324, 329, 369-371,
D21/385, 396-397; 273/138.1, 309; 463/11-13,
463/25-26, 46-47

See application file for complete search history.

(56) **References Cited**

U.S. PATENT DOCUMENTS

1,900,513	A	3/1933	Marsh	
D400,950	S	11/1998	Nally et al.	
D429,769	S *	8/2000	Luciano et al.	D21/333
6,095,524	A	8/2000	Richter et al.	
6,464,586	B1 *	10/2002	Kamata et al.	463/46

6,896,620	B1 *	5/2005	Luciano et al.	463/46
D512,466	S	12/2005	White et al.	
D547,386	S *	7/2007	Skotarczak et al.	D21/369
D547,387	S *	7/2007	Maguire et al.	D21/369
D548,801	S *	8/2007	Groswirt	D21/369
2006/0055114	A1	3/2006	White et al.	
2006/0068868	A1 *	3/2006	Crawford et al.	463/13
2006/0068871	A1 *	3/2006	Crawford et al.	463/13

* cited by examiner

Primary Examiner—Sandra L. Morris

(74) *Attorney, Agent, or Firm*—Equinox Protection; Franz
Bonsang, Patent Agent

(57) **CLAIM**

The ornamental design for a poker table, as shown.

DESCRIPTION

FIG. 1 is a top perspective view of a poker table showing our
new design;

FIG. 2 is a top plan view thereof;

FIG. 3 is a front elevational view thereof;

FIG. 4 is a bottom plan view thereof;

FIG. 5 is a left side elevational view thereof;

FIG. 6 is a right side elevational view thereof; and,

FIG. 7 is a rear elevational view thereof.

1 Claim, 7 Drawing Sheets

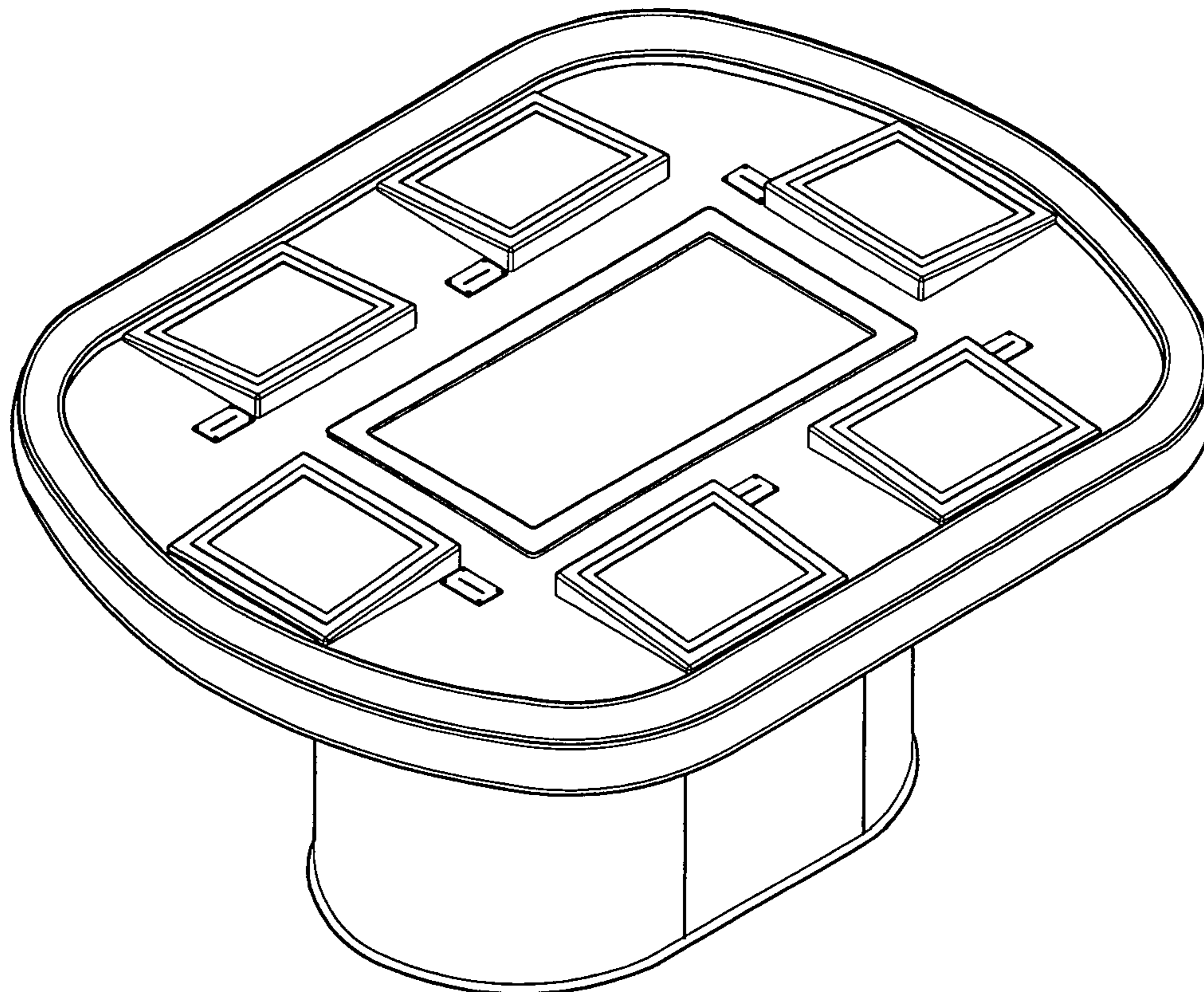

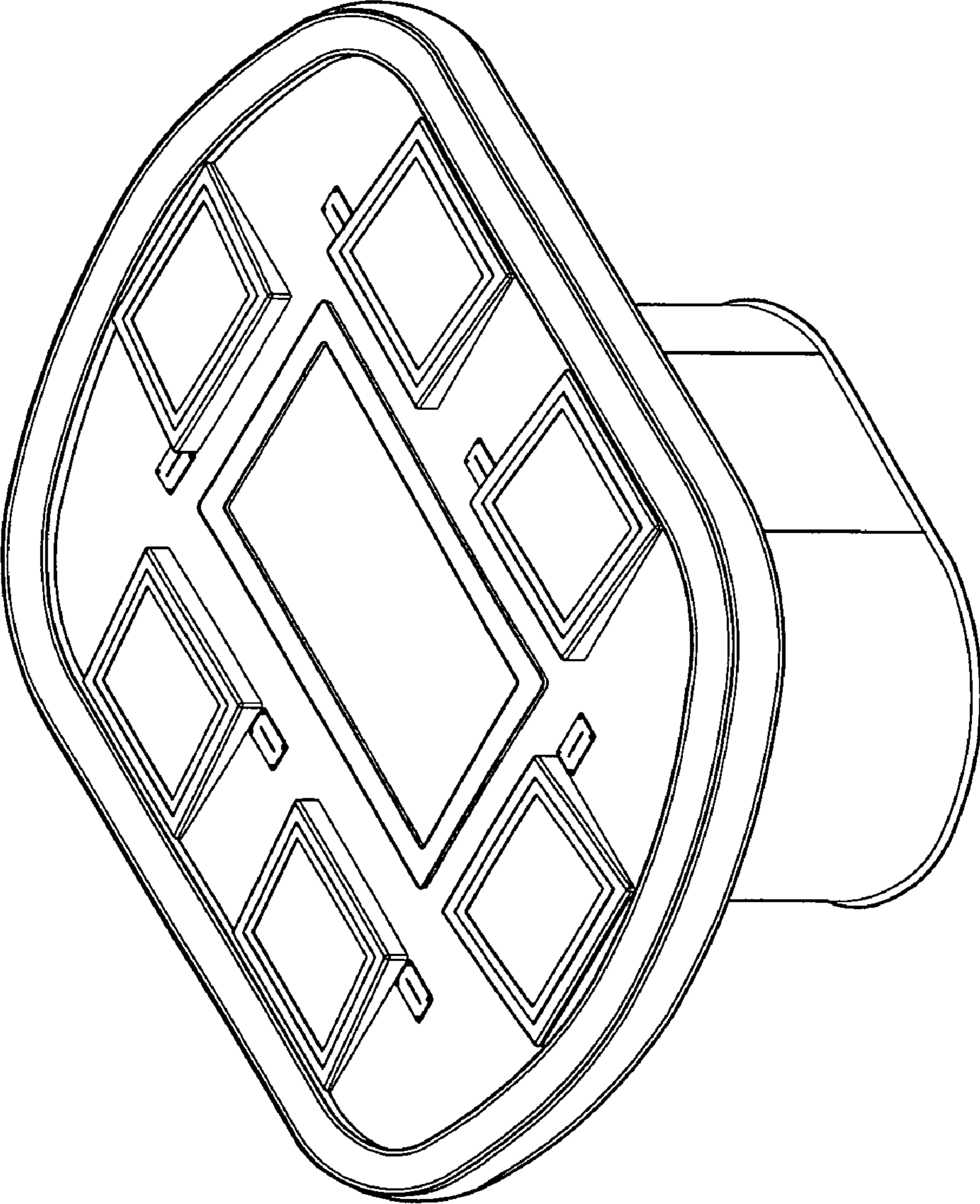

FIG.1

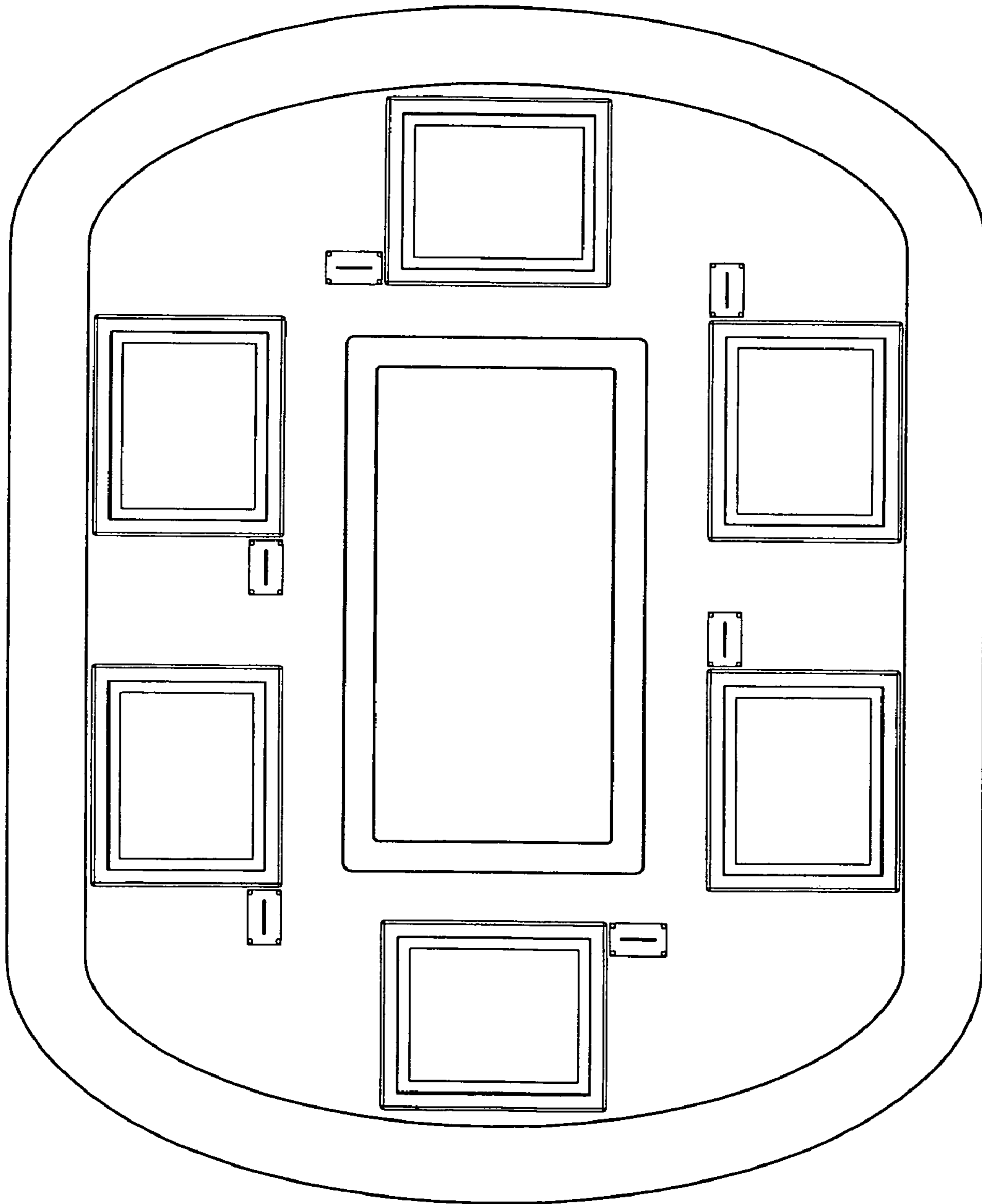

FIG.2

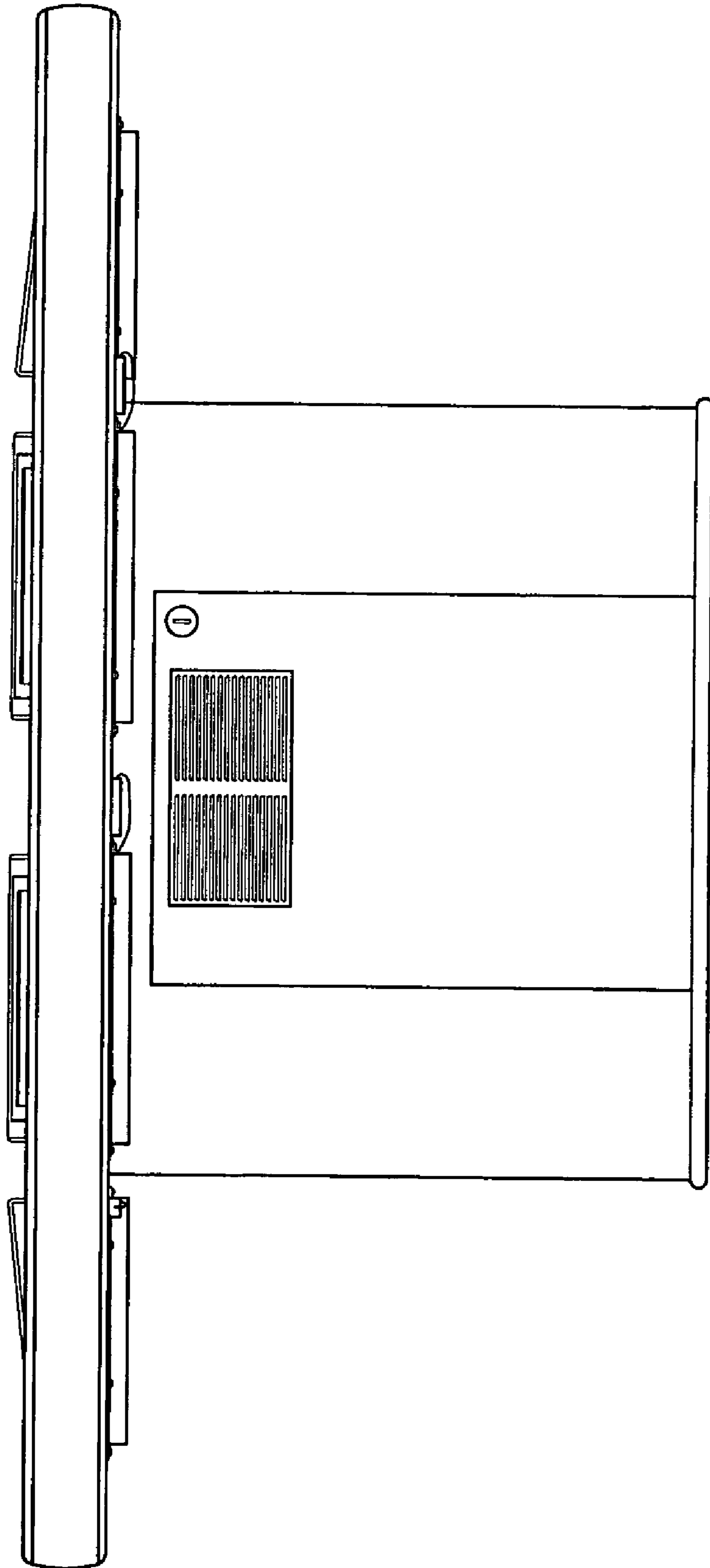

FIG.3

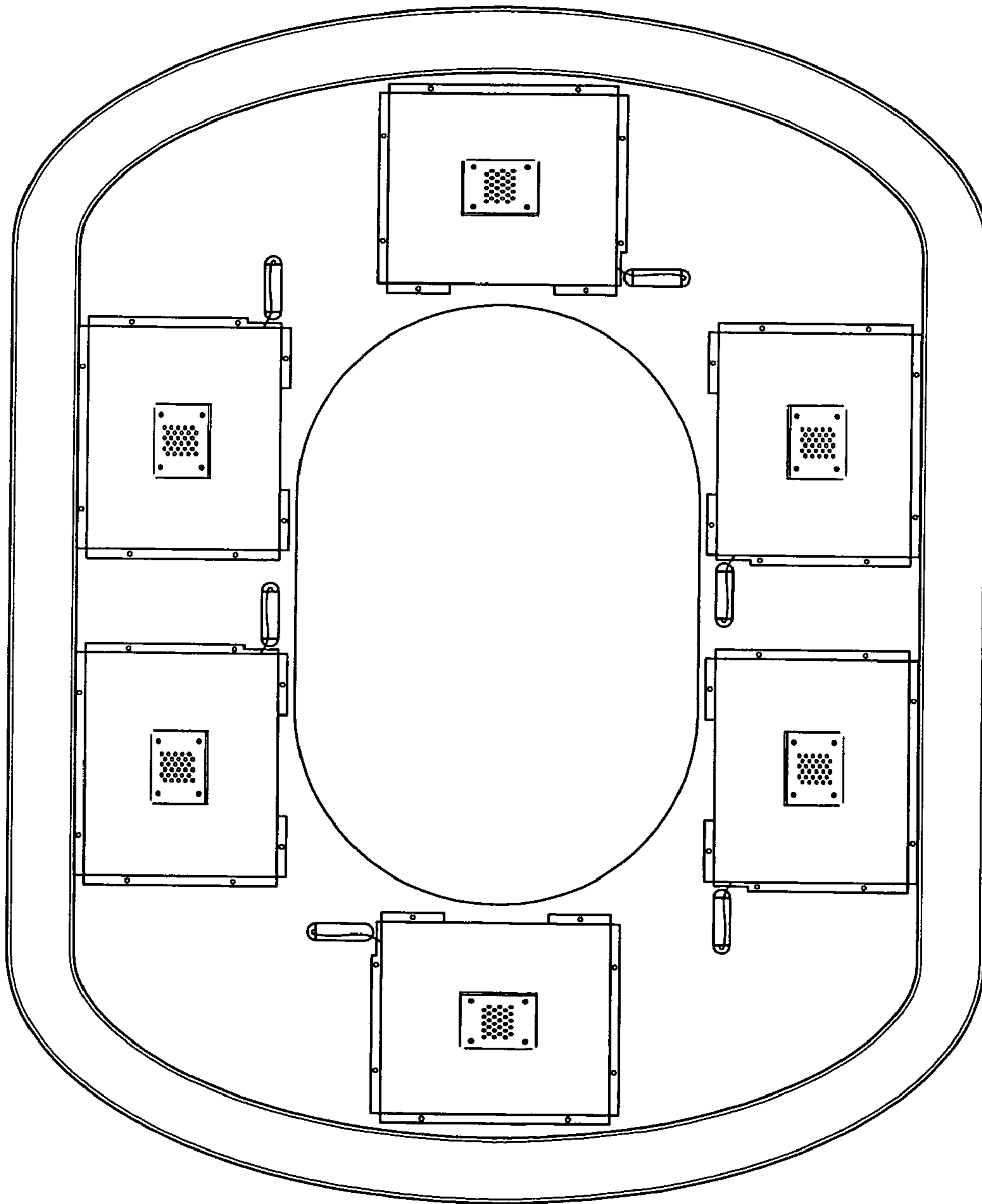

FIG.4

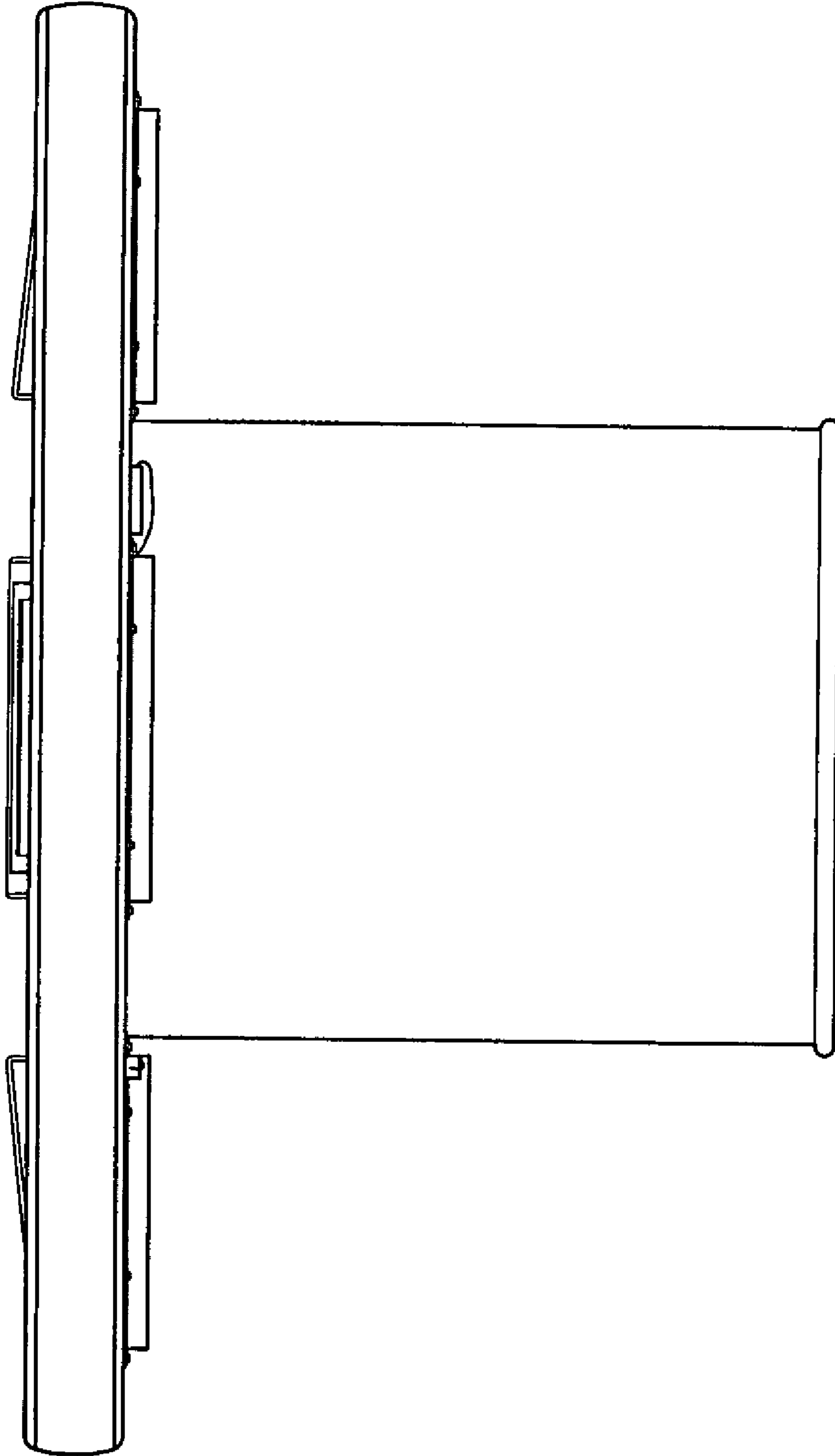

FIG. 5

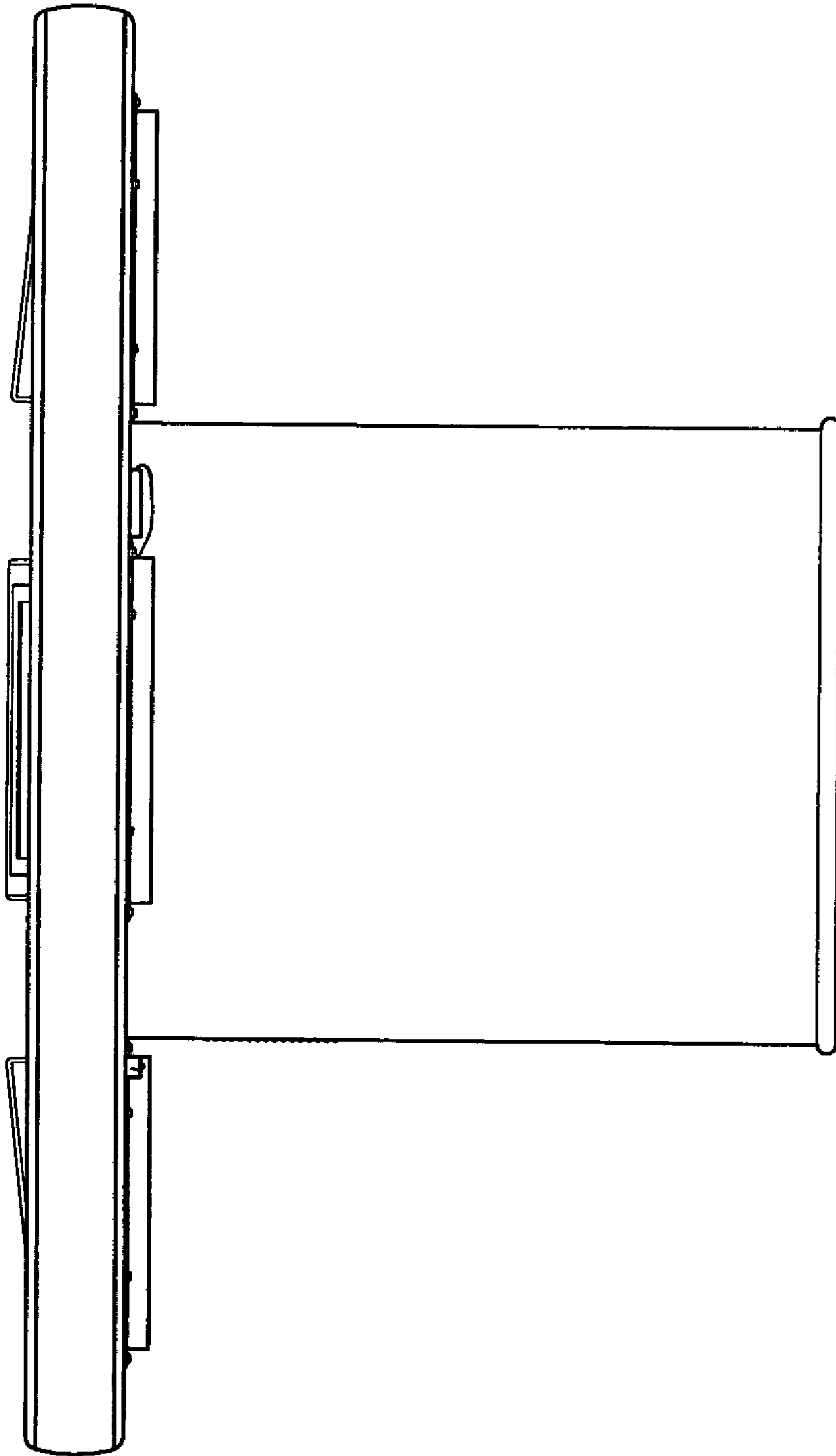

FIG. 6

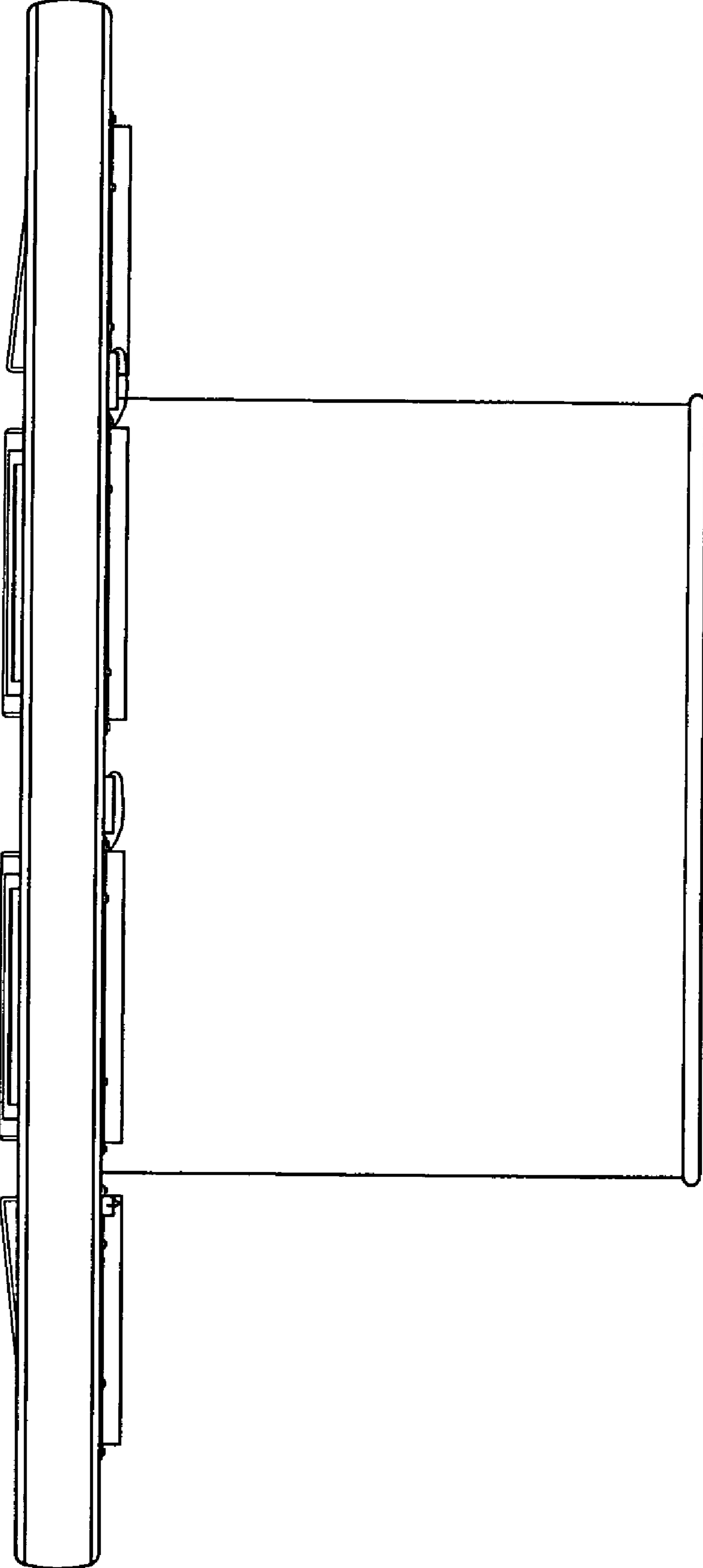

FIG.7