



US00D561832S

(12) **United States Design Patent**
Bhavnani

(10) **Patent No.:** **US D561,832 S**

(45) **Date of Patent:** **** Feb. 12, 2008**

- (54) **PEN**
- (75) Inventor: **Dilip Bhavnani**, Beverly Hills, CA (US)
- (73) Assignee: **Sun Coast Merchandise Corporation**, Commerce, CA (US)

- 6,050,735 A * 4/2000 Hazzard 401/33
- D424,112 S * 5/2000 Hazzard D19/54
- D430,606 S * 9/2000 Veillon D19/48
- D436,624 S * 1/2001 Zier D19/48
- D446,212 S * 8/2001 Chang D14/411
- D468,771 S * 1/2003 Holland et al. D19/51
- D495,742 S * 9/2004 Collin D19/43

(**) Term: **14 Years**

* cited by examiner

(21) Appl. No.: **29/283,162**

Primary Examiner—Elizabeth A. Albert

(74) *Attorney, Agent, or Firm*—The Soni Law Firm

(22) Filed: **Aug. 7, 2007**

(57) **CLAIM**

(51) **LOC (8) Cl.** **19-06**

The ornamental design for a pen, as shown and described.

(52) **U.S. Cl.** **D19/51**

(58) **Field of Classification Search** D19/35,
D19/36, 41–51, 53–57; 24/11 R, 11 F, 11 P;
401/52, 99, 100, 104, 105, 106, 107, 108,
401/109, 192, 195, 196

DESCRIPTION

See application file for complete search history.

FIG. 1 is a front bottom side perspective view of the pen showing my new design;

FIG. 2 is a front elevational view thereof;

FIG. 3 is a left elevational view thereof which is a mirror image of the right elevational view thereof;

FIG. 4 is a back elevational view thereof;

FIG. 5 is a bottom plan view thereof; and,

FIG. 6 is a top plan view thereof.

(56) **References Cited**

U.S. PATENT DOCUMENTS

- D179,615 S * 1/1957 Spatz D28/4
- D193,373 S * 8/1962 Rhoades D19/51
- D327,621 S * 7/1992 Heller D8/82
- D402,690 S * 12/1998 Hazzard D19/51
- 5,913,629 A * 6/1999 Hazzard 401/33

1 Claim, 2 Drawing Sheets

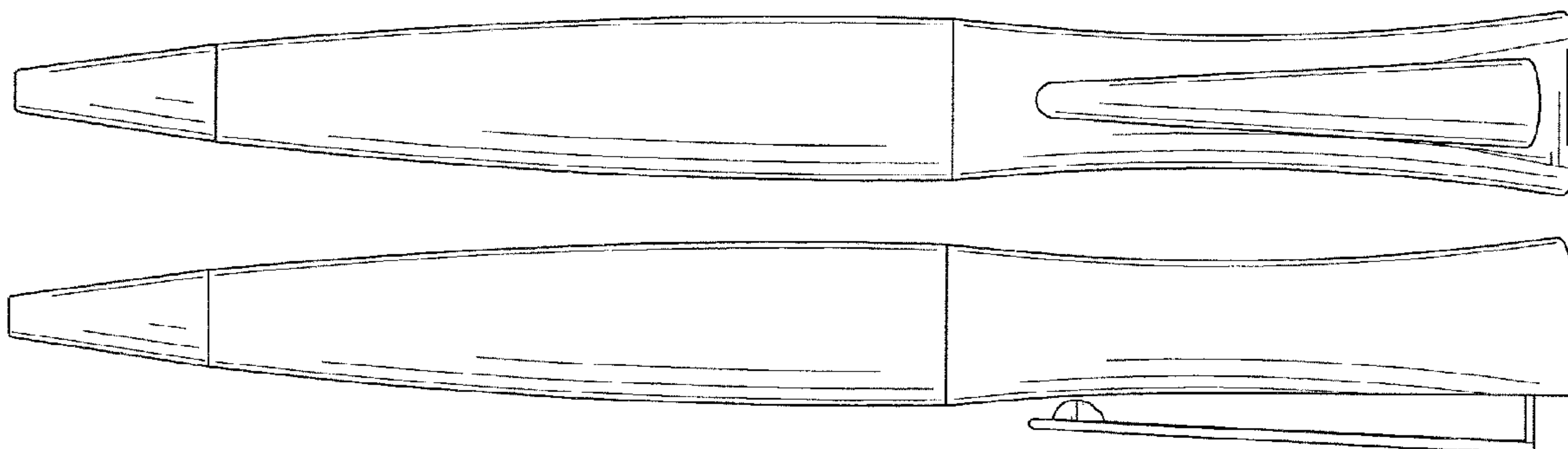

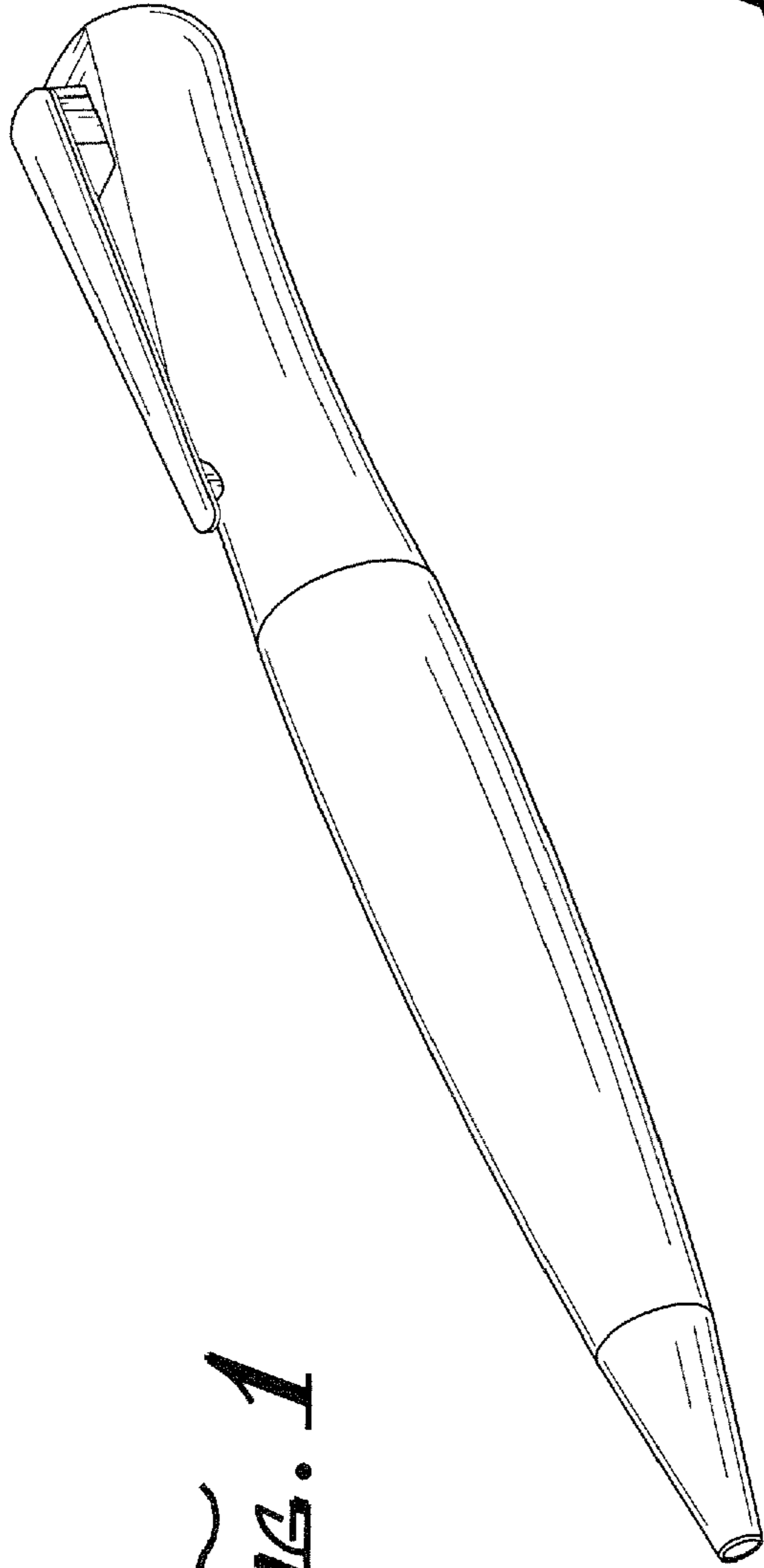

FIG. 1

FIG. 2

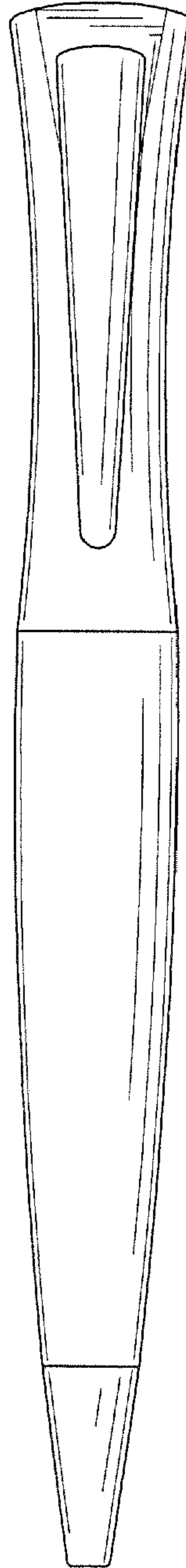

FIG. 3

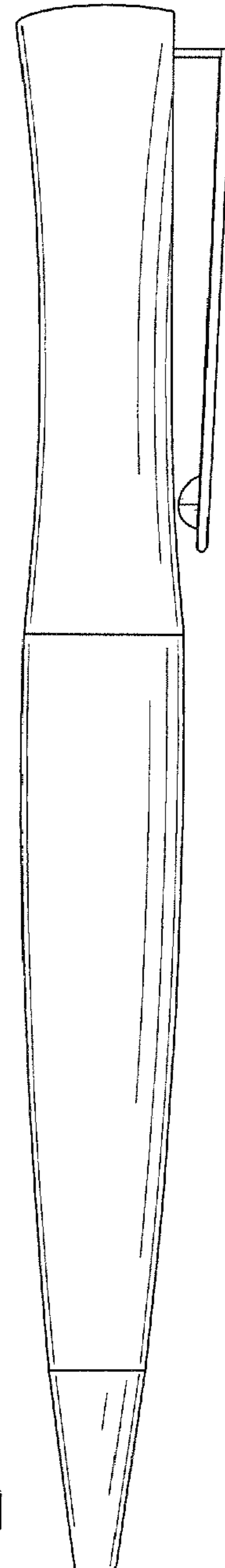

FIG. 4

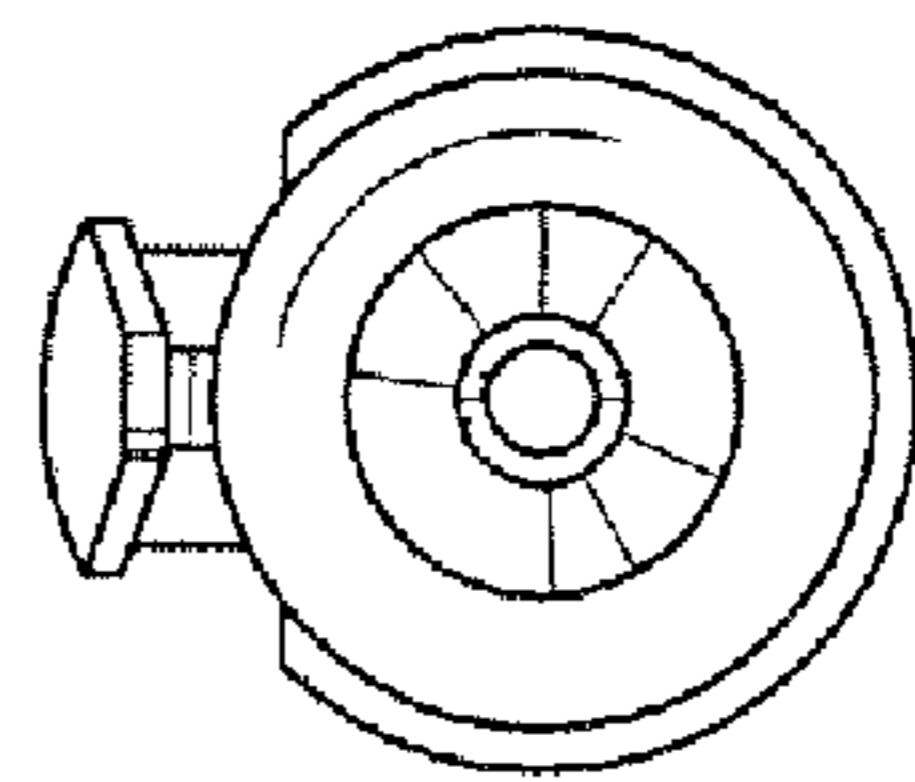
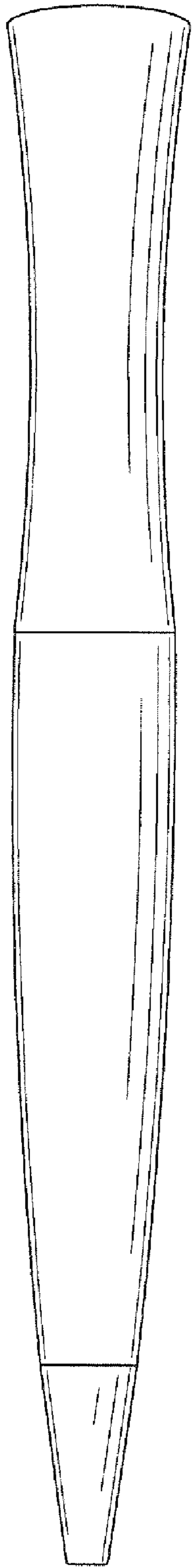

FIG. 5

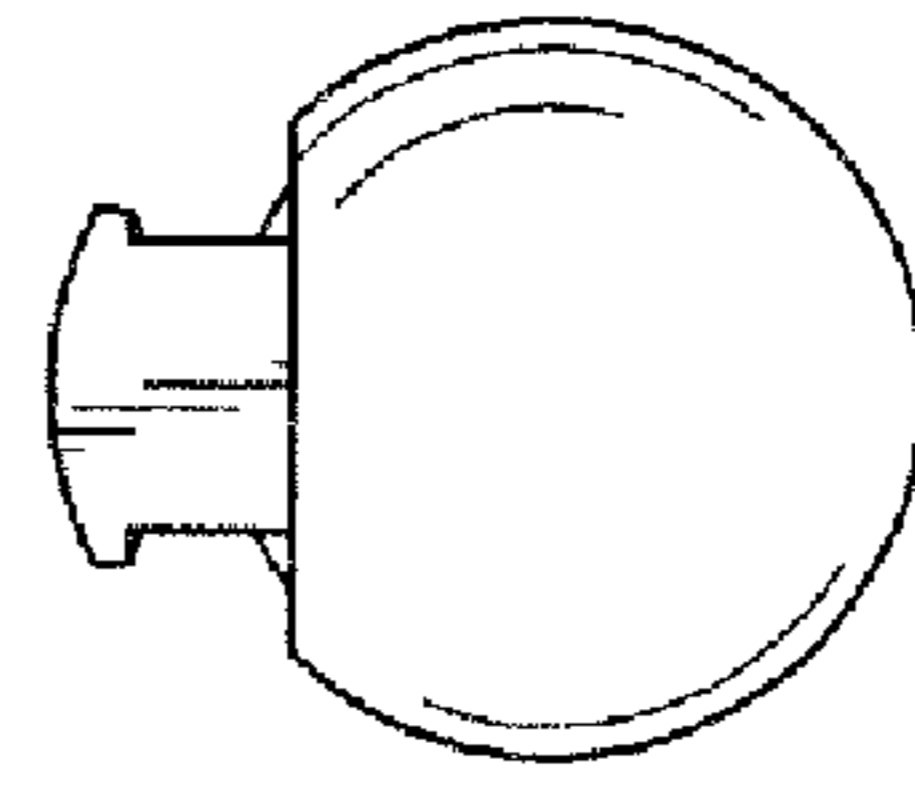

FIG. 6