



US00D561722S

(12) **United States Design Patent**
Kim et al.

(10) **Patent No.:** **US D561,722 S**

(45) **Date of Patent:** **** Feb. 12, 2008**

(54) **MOBILE PHONE**

(75) Inventors: **Kuk-Hwan Kim**, Seoul (KR);
Beom-Ku Han, Seoul (KR);
Chang-Hwan Hwang, Goyang-si (KR)

(73) Assignee: **Samsung Electronics Co., Ltd.**,
Suwon-Si (KR)

(**) Term: **14 Years**

(21) Appl. No.: **29/272,155**

(22) Filed: **Feb. 2, 2007**

(30) **Foreign Application Priority Data**

Nov. 29, 2006 (KR) 30-2006-0047365

(51) **LOC (8) Cl.** **14-03**

(52) **U.S. Cl.** **D14/138**

(58) **Field of Classification Search** D14/496,
D14/138, 341-347; 455/575.3, 575.1; D21/517,
D21/329, 333

See application file for complete search history.

(56) **References Cited**

U.S. PATENT DOCUMENTS

D349,118	S	*	7/1994	Yuen	D14/218
D488,154	S	*	4/2004	Lovelady et al.	D14/345
D496,014	S	*	9/2004	Lodato et al.	D14/138
D496,636	S	*	9/2004	Lodato et al.	D14/138
D500,750	S	*	1/2005	Arnholt et al.	D14/138
D501,838	S	*	2/2005	Kim et al.	D14/138
D518,467	S	*	4/2006	Kim et al.	D14/138
D536,320	S	*	2/2007	Michaels	D14/138
D541,248	S	*	4/2007	Lee et al.	D14/138
D543,172	S	*	5/2007	Lee et al.	D14/138
D543,525	S	*	5/2007	Kim et al.	D14/138
7,212,845	B2	*	5/2007	Ikeuchi	455/575.3
D543,965	S	*	6/2007	Lee et al.	D14/138
D545,287	S	*	6/2007	Han et al.	D14/138
D546,307	S	*	7/2007	Lee	D14/138
D548,212	S	*	8/2007	Lee	D14/138
2003/0092401	A1	*	5/2003	Ikeuchi	455/90
2004/0203535	A1	*	10/2004	Kim et al.	455/90.3
2005/0113156	A1	*	5/2005	Park et al.	455/575.4
2005/0245296	A1	*	11/2005	Hong et al.	455/575.3
2005/0282596	A1	*	12/2005	Park et al.	455/575.3
2006/0019728	A1	*	1/2006	Sakamoto et al.	455/575.3

2006/0135225	A1	*	6/2006	Lin et al.	455/575.3
2006/0135226	A1	*	6/2006	Won et al.	455/575.3
2007/0026909	A1	*	2/2007	Jung et al.	455/575.3

FOREIGN PATENT DOCUMENTS

WO	DM/067361	*	9/2005
WO	DM/067683	*	3/2006
WO	DM/067801	*	4/2006

OTHER PUBLICATIONS

Samsung D550 telephone, announced Jun. 2005, [online], [retrieved on Feb. 2, 2007]. Retrieved from Internet, <URL: <http://www.gsmarena.com>>.*

Samsung D300 telephone, announced Feb. 2006, [online], [retrieved on Feb. 2, 2007]. Retrieved from Internet, <URL: <http://www.gsmarena.com>>.*

Pantech PG-2800 telephone, announced May. 2006, [online], [retrieved on Jun. 27, 2007]. Retrieved from Internet, <URL: <http://www.gsmarena.com>>.*

BenQ-Siemens EF71 telephone, announced May 2006, [online], [retrieved on Aug. 16, 2007]. Retrieved from Internet, <URL: <http://www.gsmarena.com>>.*

* cited by examiner

Primary Examiner—Jeffrey Asch

(74) *Attorney, Agent, or Firm*—Staas & Halsey LLP

(57) **CLAIM**

The ornamental design for the mobile phone, as shown and described.

DESCRIPTION

FIG. 1 is a perspective view of a mobile phone;
FIG. 2 is a front view of the mobile phone of FIG. 1;
FIG. 3 is a rear view of the mobile phone of FIG. 1;
FIG. 4 is a left-side view of the mobile phone of FIG. 1;
FIG. 5 is a right-side view of the mobile phone of FIG. 1;
FIG. 6 is a top plan view of the mobile phone of FIG. 1;
FIG. 7 is a bottom plan view of the mobile phone of FIG. 1;
and,
FIG. 8 is an open perspective view of the mobile phone of FIG. 1.

1 Claim, 5 Drawing Sheets

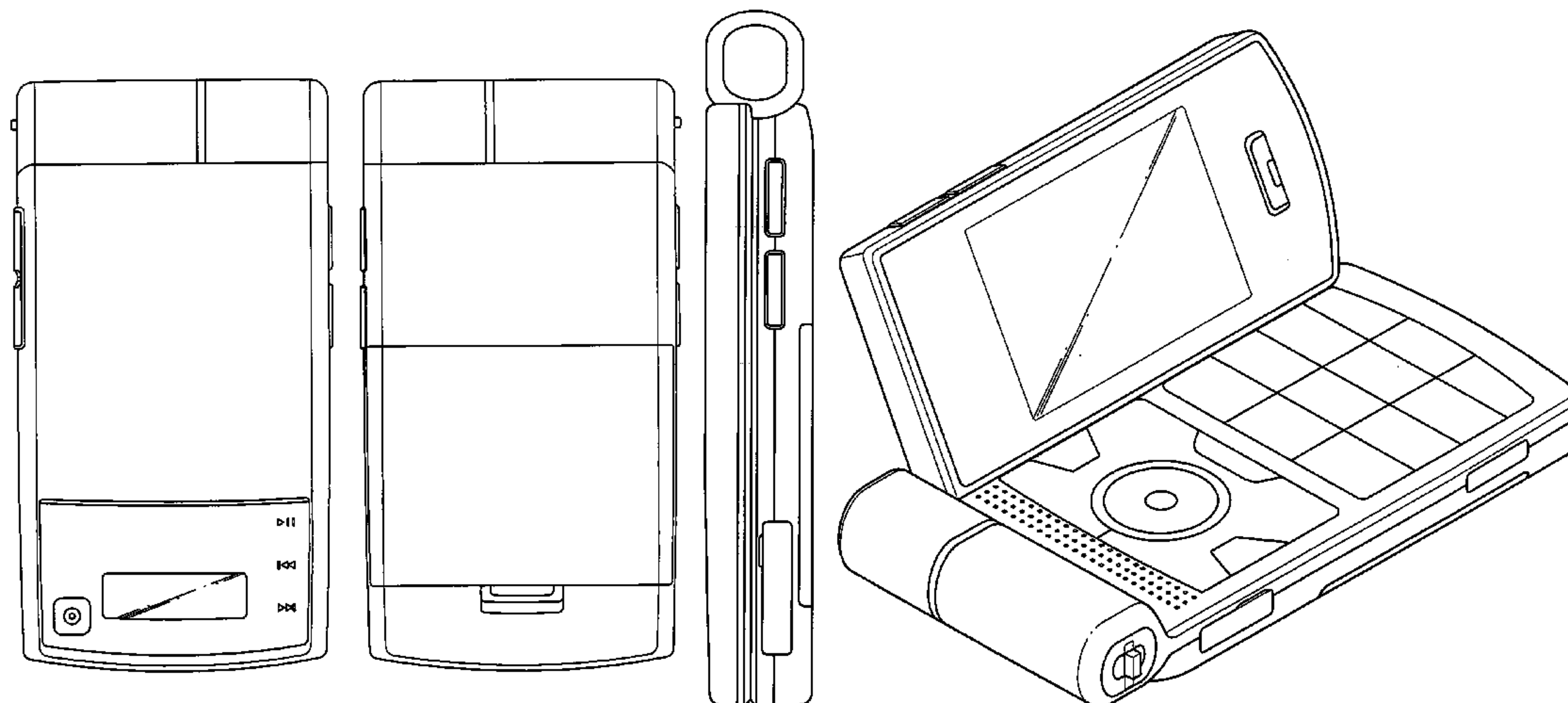

FIG. 1

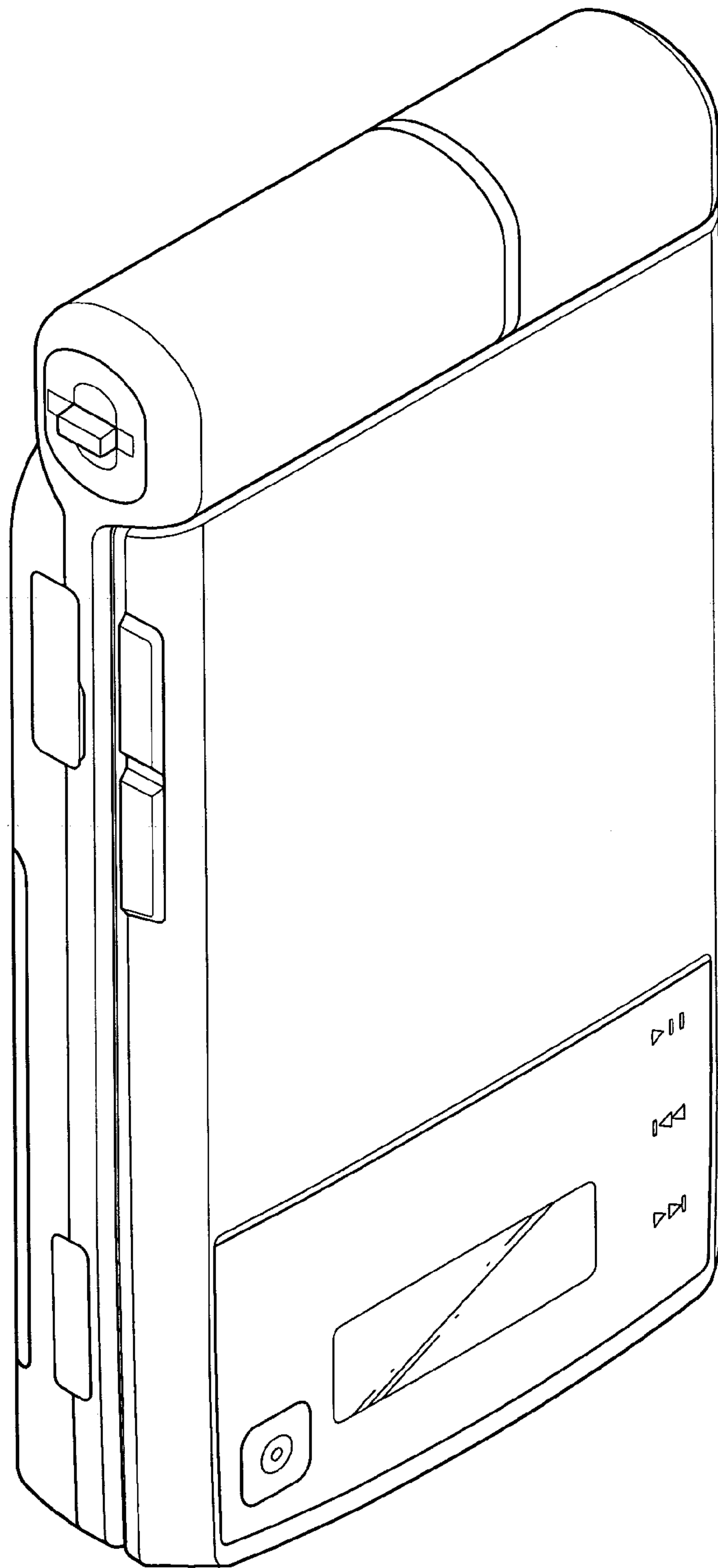

FIG.2

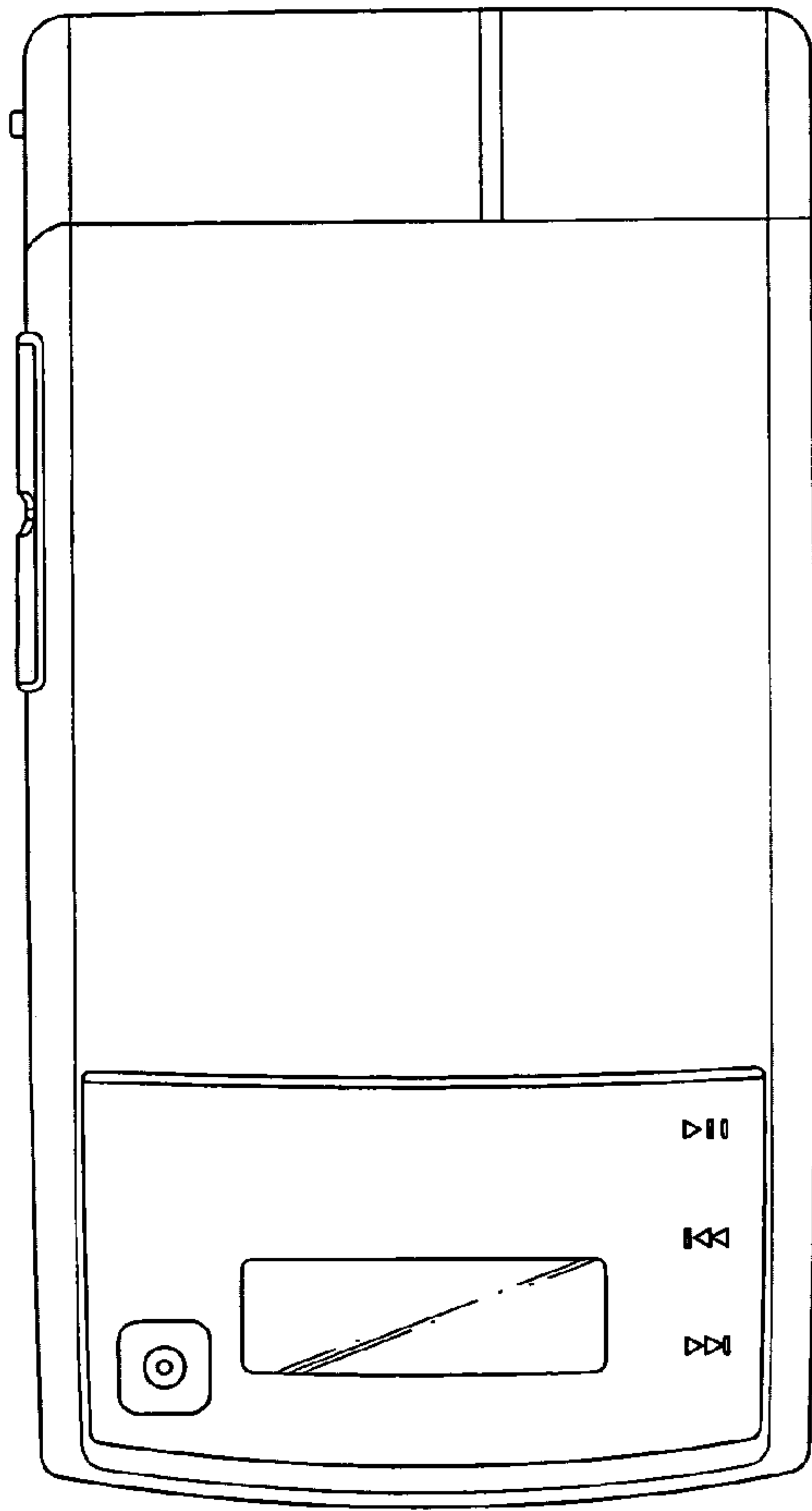

FIG.3

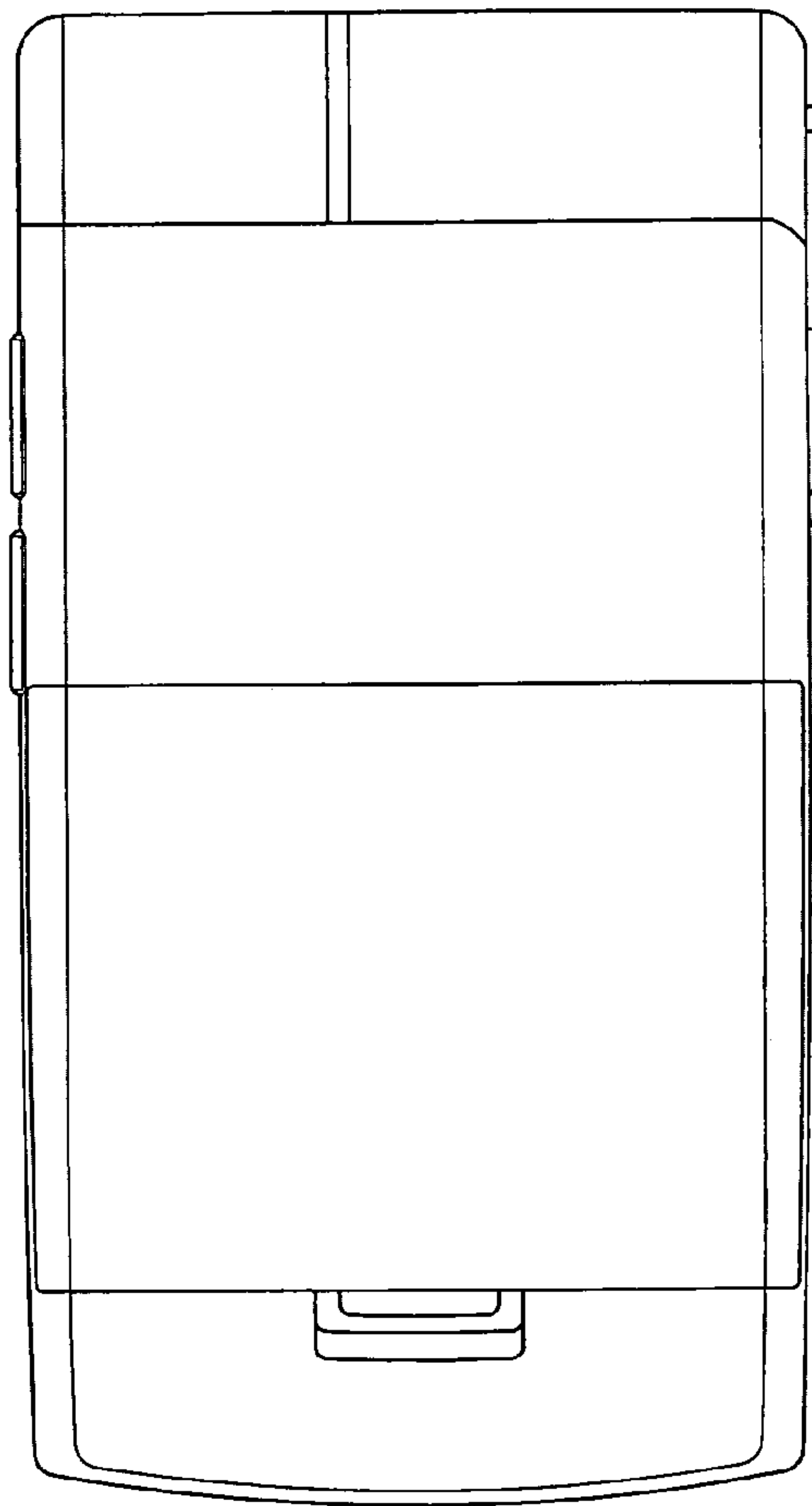

FIG.4

FIG.5

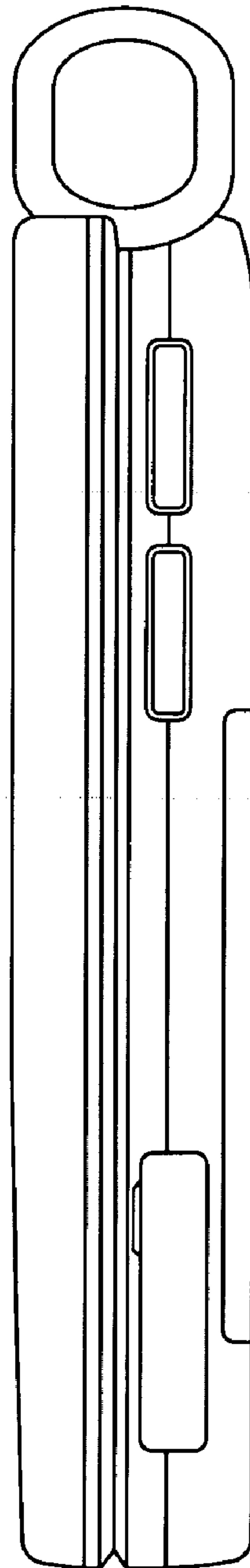
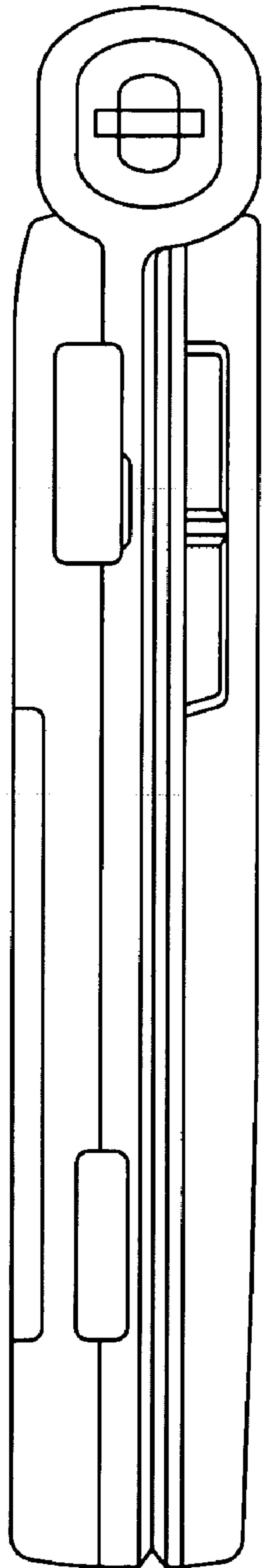

FIG.6

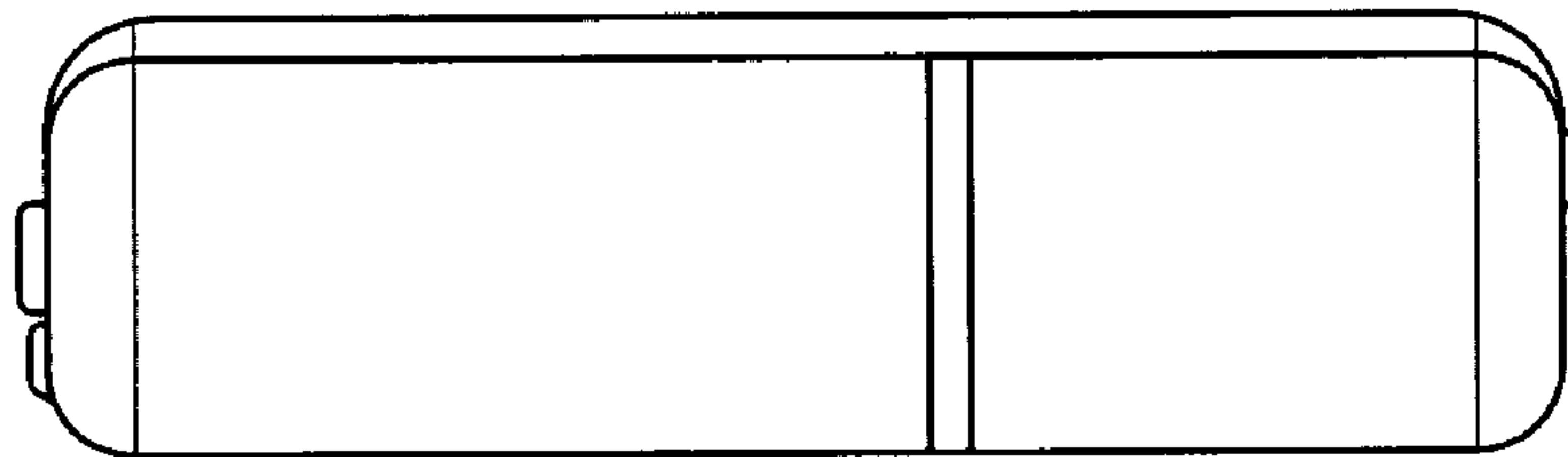

FIG.7

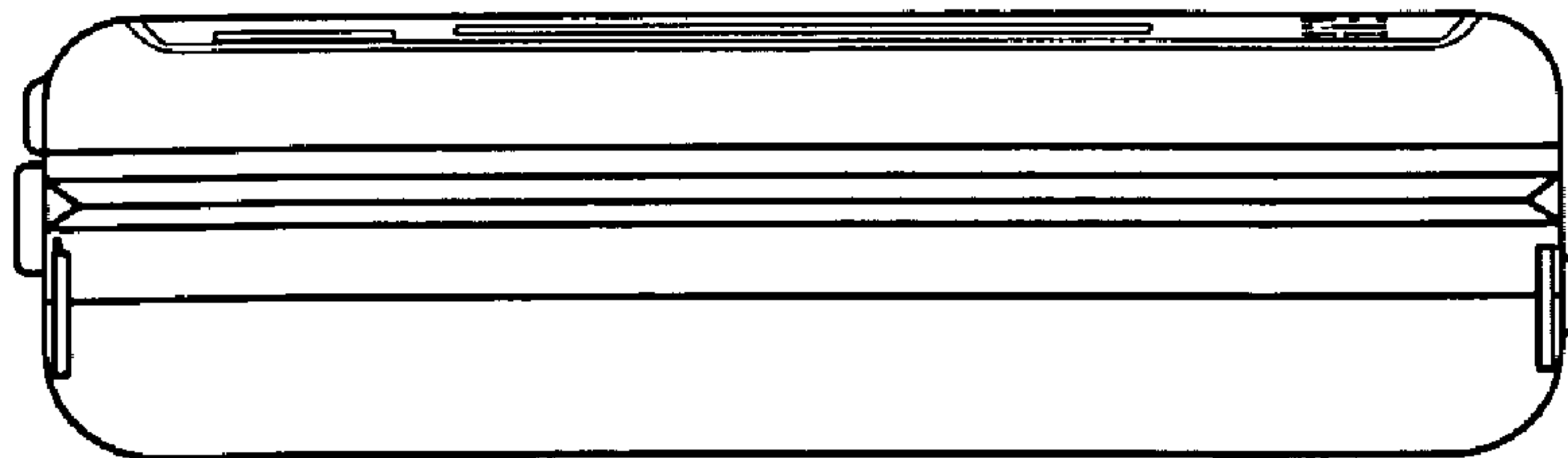

FIG.8

