



US00D561669S

(12) **United States Design Patent**
Sato et al.

(10) **Patent No.:** **US D561,669 S**
(45) **Date of Patent:** **** Feb. 12, 2008**

(54) **DOOR MIRROR OF MOTOR VEHICLE**

D549,142 S * 8/2007 Sinkwitz D12/187

(75) Inventors: **Youichi Sato**, Hiroshima (JP); **Dai Kimura**, Hiroshima (JP); **Hitomaro Asano**, Hiroshima (JP); **Kazuya Hamada**, Hiroshima (JP); **Kenji Hirozawa**, Hiroshima (JP); **Kenji Kato**, Hiroshima (JP)

FOREIGN PATENT DOCUMENTS

JP D1110309 6/2001
JP D1226135 12/2004
JP D1226156 12/2004

* cited by examiner

Primary Examiner—Stacia Cadmus

(73) Assignee: **Mazda Motor Corporation**, Hiroshima (JP)

(74) *Attorney, Agent, or Firm*—Nixon Peabody LLP; Donald R. Studebaker

(**) Term: **14 Years**

(57) **CLAIM**

(21) Appl. No.: **29/287,133**

The ornamental design for a door mirror of motor vehicle, as shown and described.

(22) Filed: **Jul. 2, 2007**

(51) **LOC (8) Cl.** **12-16**

(52) **U.S. Cl.** **D12/187**

(58) **Field of Classification Search** D12/187-189;
359/838-851, 855-868, 871-881; 248/475.1,
248/476, 480-481, 485-487

See application file for complete search history.

DESCRIPTION

FIG. 1 is a perspective view of a door mirror of motor vehicle;

FIG. 2 is a front view thereof;

FIG. 3 is a rear view thereof;

FIG. 4 is a left side view thereof

FIG. 5 is a right side view thereof;

FIG. 6 is a top view thereof; and,

FIG. 7 is a bottom view thereof.

(56) **References Cited**

U.S. PATENT DOCUMENTS

D455,690 S * 4/2002 Lee D12/187
D464,922 S * 10/2002 Kuo D12/187
D511,127 S * 11/2005 Elmitt D12/187

1 Claim, 4 Drawing Sheets

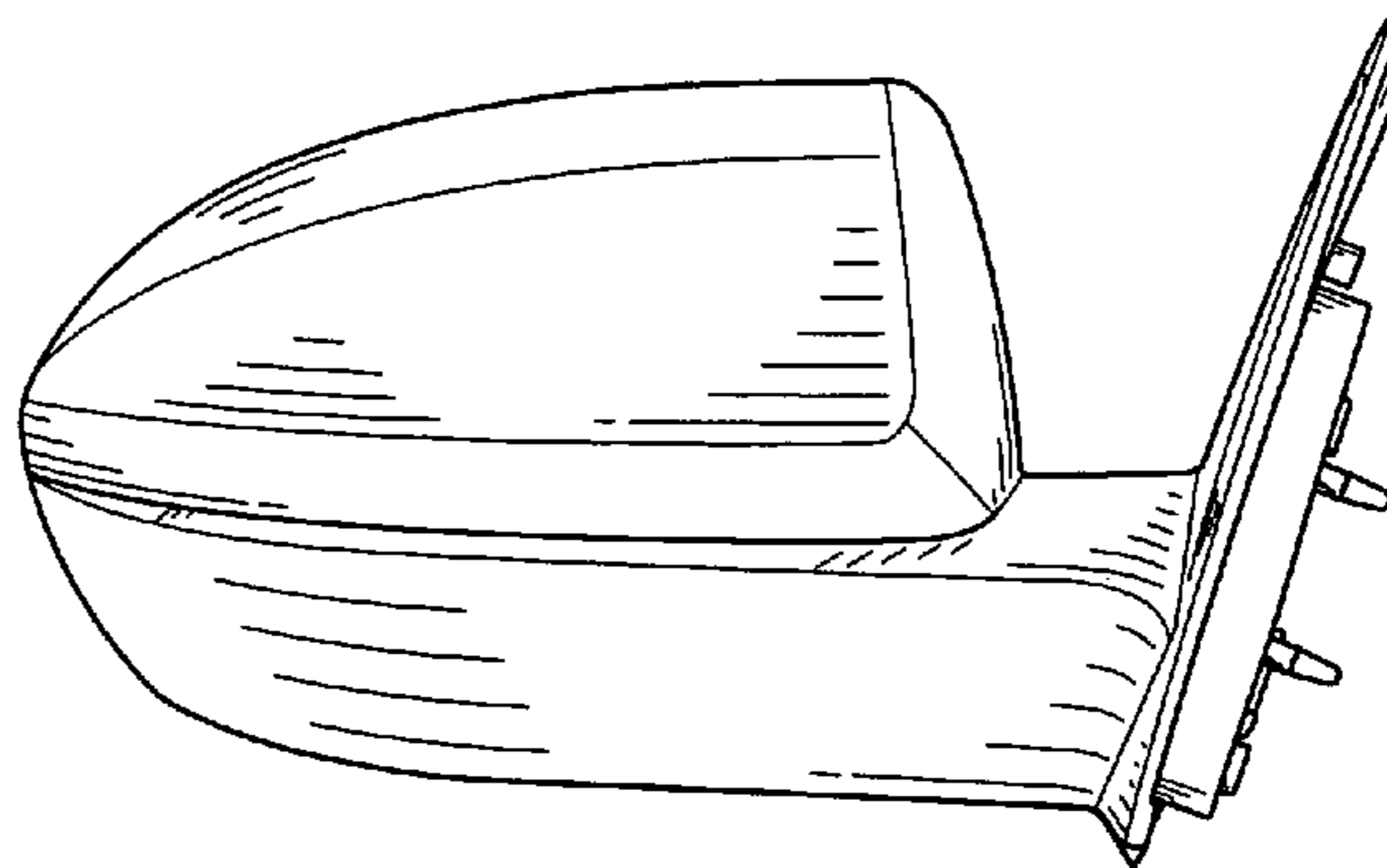
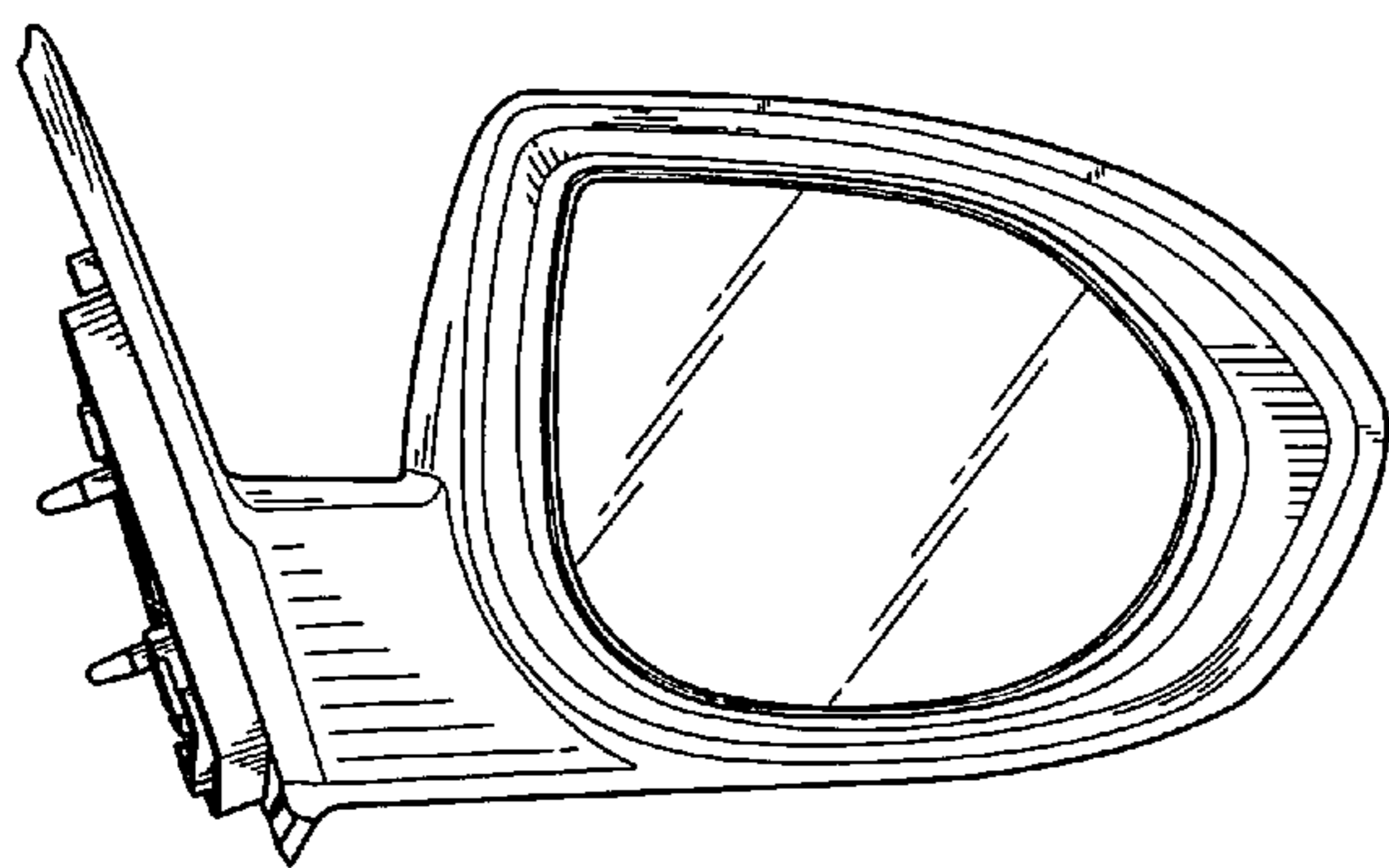

FIG.1

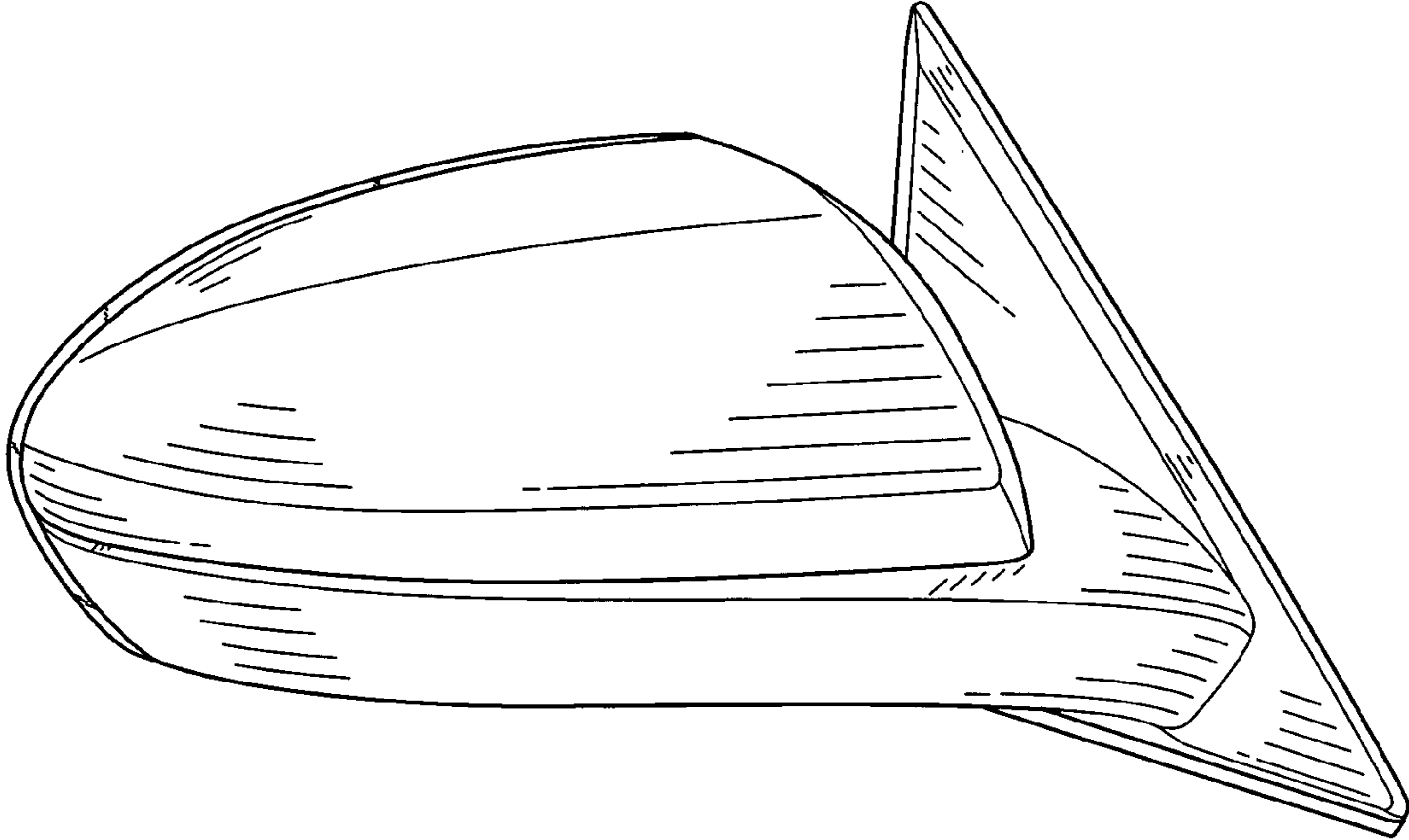

FIG.2

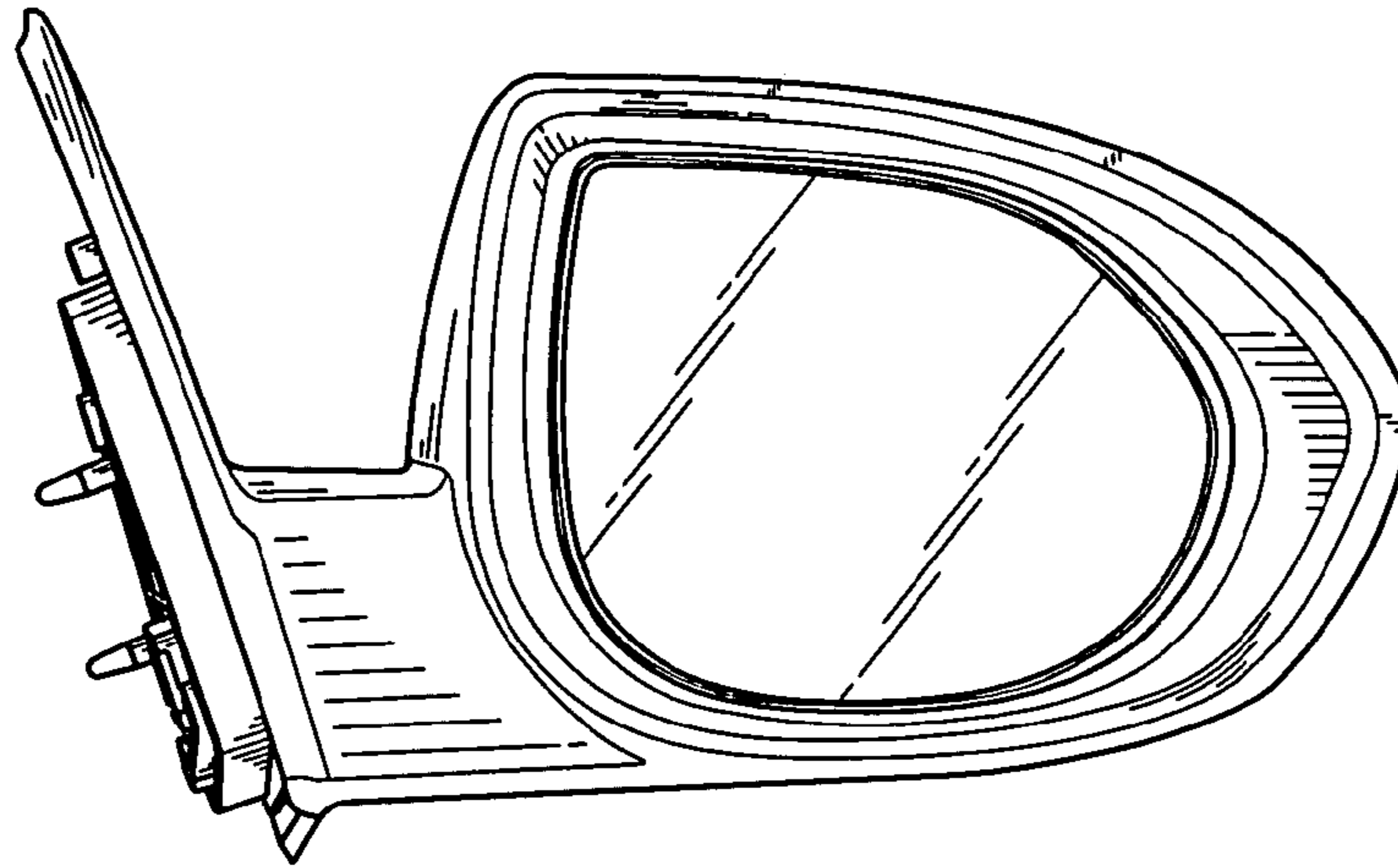

FIG.3

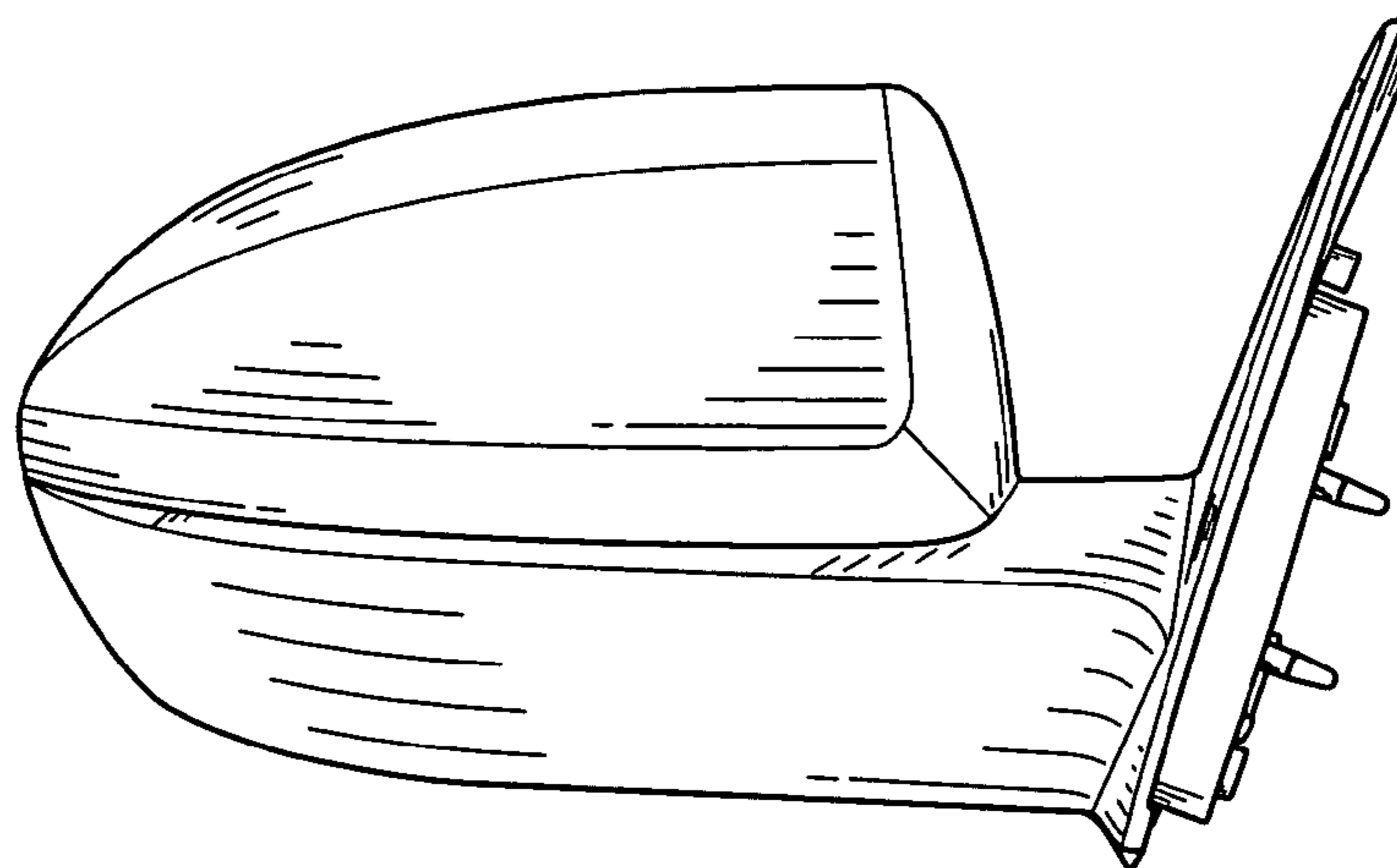

FIG.4

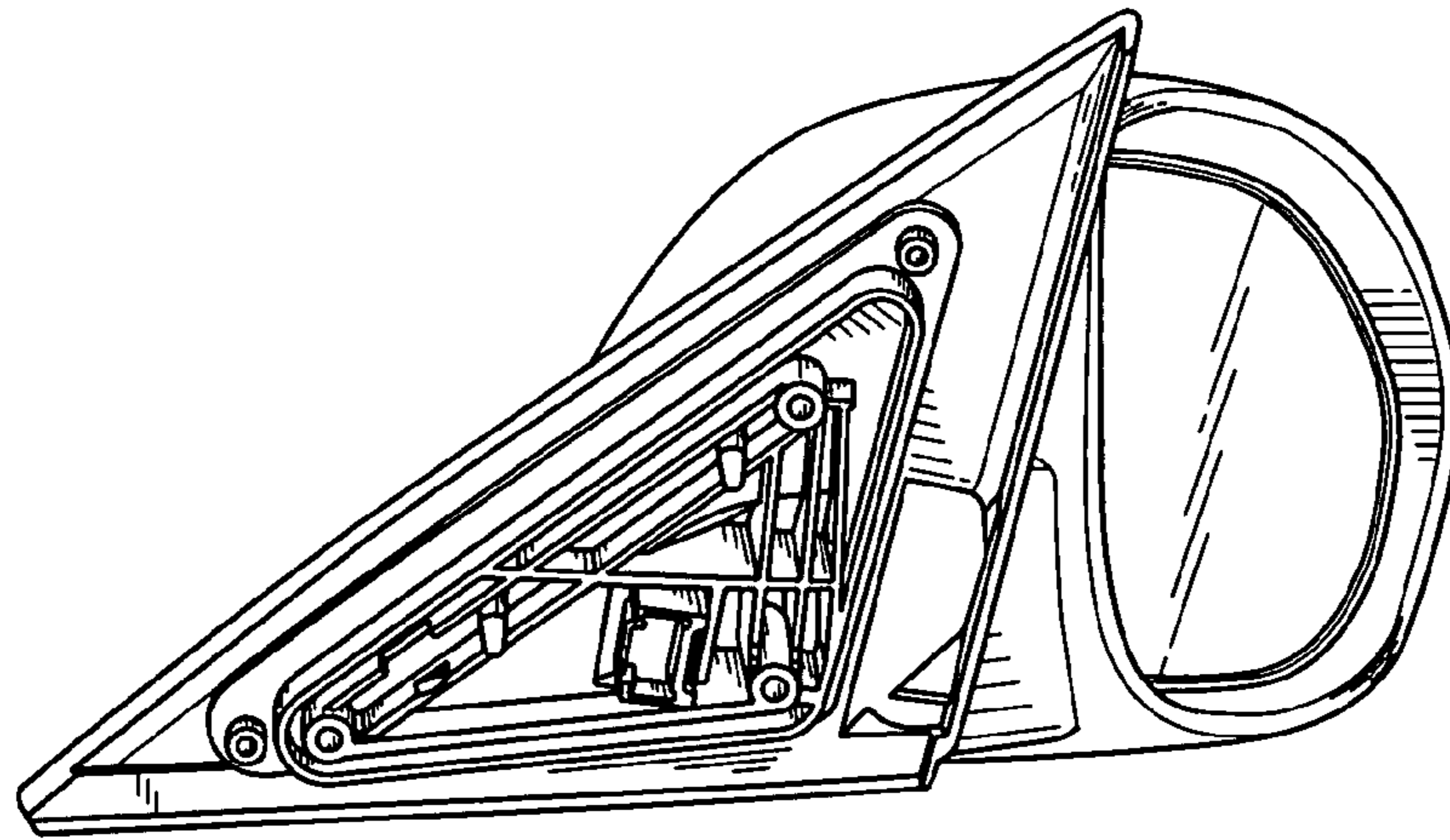

FIG.5

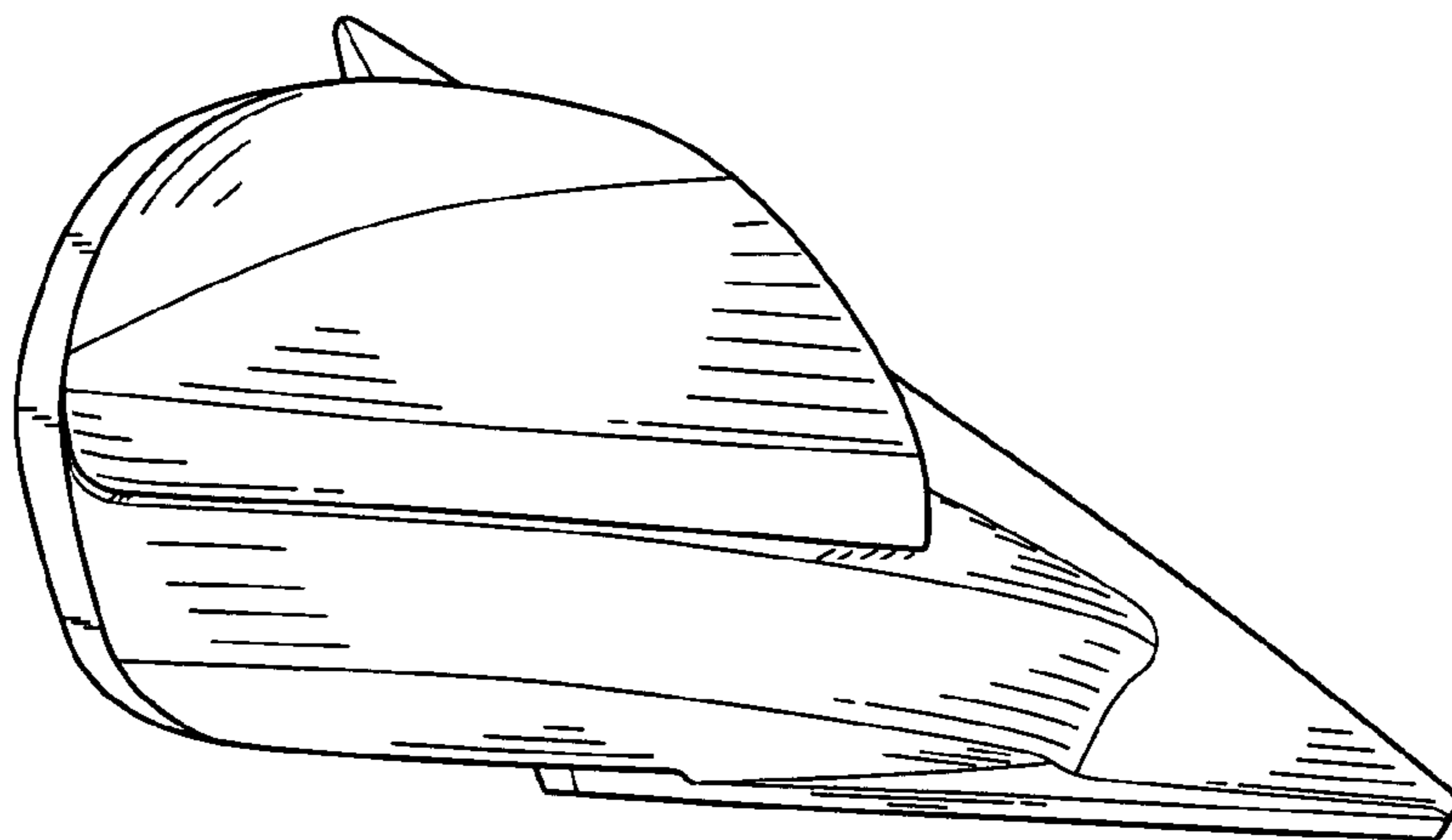

FIG.6

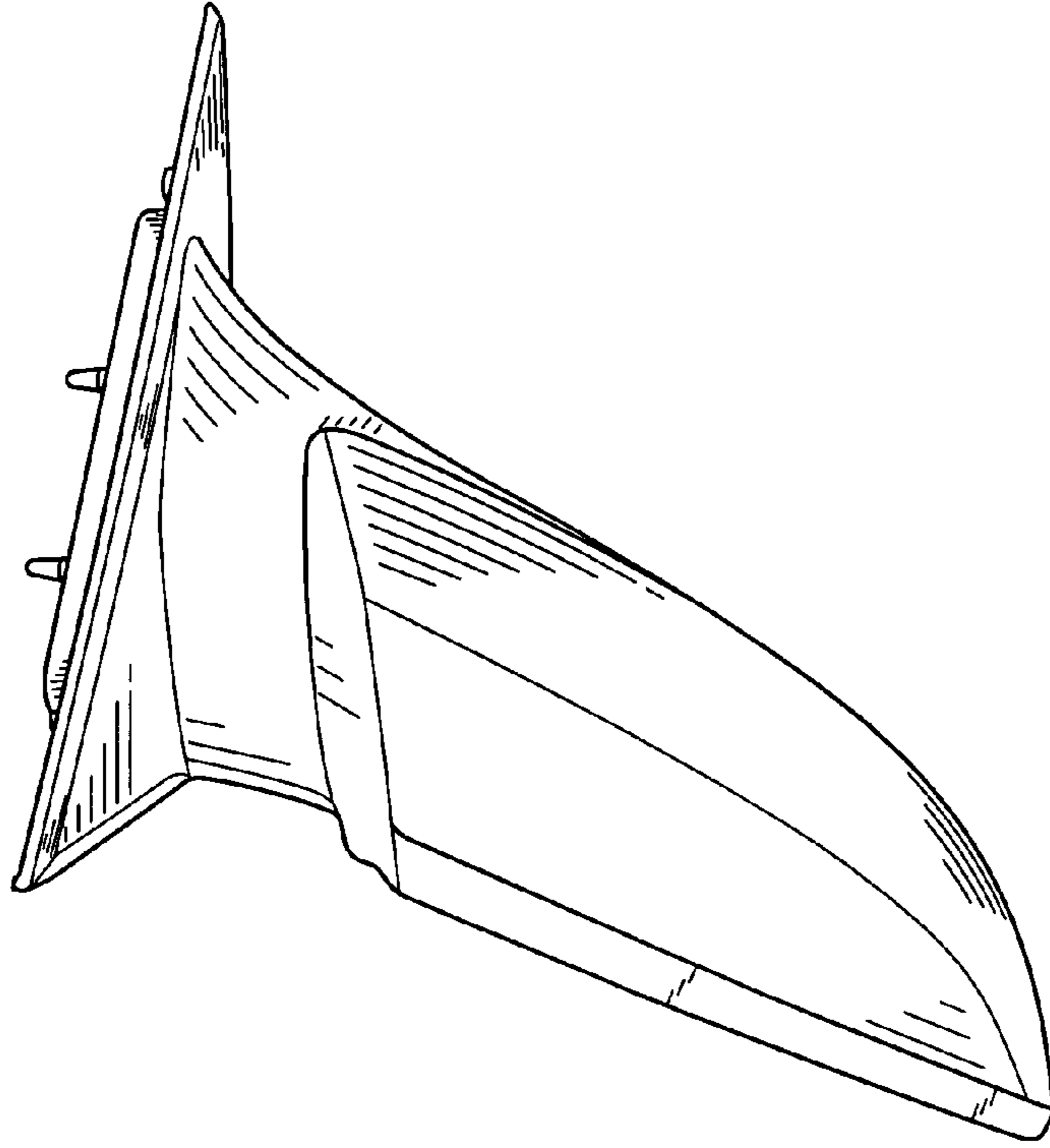

FIG.7

